

PROFI SZERSZÁMOK MOTORKERÉKPÁROK JAVÍTÁSÁHOZ, KARBANTARTÁSÁHOZ



* A kiválasztott NEO termékek 25 év garanciával és TÜV M + T (Megfigyelés - tesztelés) tanúsítvánnyal rendelkeznek - részletek a neo-tools.com oldalon találhatóak.

NEO
TOOLS

CSAK A LEGJOBB
SZERSZÁMOKAT AJÁNLUJUK

A NEO TOOLS...

- csúcskategóriás eszközök profi szakembereknek és igényes felhasználóknak
- a termékek gyártása során használt legújabb technológiák és anyagok
- 25 év garancia* a minőségre és megbízhatóságra



MINŐSÉG

A NEO TOOLS minőségi szabványainak legfontosabb alapjai a kiváló minőségű anyagok és a jól bevált műszaki megoldások. A magas minőség és a precíz kivitelezés teszi a NEO TOOLS szerszámokat alkalmassá a legnehezebb körülmények között történő használatra. A NEO TOOLS termékeket szaklaboratóriumokban és a szakemberek munkahelyein is tesztelik.

LABORATÓRIUM

A NEO TOOLS szerszámokat speciális és szigorú tartóssági teszteknek vetik alá. A tesztek minősége az európai szabványokon alapul. A műszaki osztály minőségirányítási rendszere az ISO 9001:2015 minőségellenőrzés egyik legfontosabb szabványa szerint tanúsított.



MOTORKERÉKPÁROK - AZ ÖN VILÁGA, A MI ESZKÖZEINK!

A motorkerékpár-szerszámok választékában több mint 1000 kiváló minőségű termék található. A NEO TOOLS termékek között mind az igényes felhasználók, mind a profi szakemberek megtalálják az ideális szerszámokat a motorkerékpár szezonra való felkészítéséhez és az esetleges javítások elvégzéséhez. A NEO Tools segítségével motorkerékpárját üzembiztosan és balesetmentesen használhatja az utakon!

MOTORKERÉKPÁR SZERSZÁMOK ÉS KIEGÉSZÍTŐK



neo-tools.com



MOTORKERÉKPÁR ELSŐTENGYEL KULCS

6 AZ 1-BEN



Ref.	EAN
10-501	5907558466324

MOTORKERÉKPÁR GYÚJTÁSBEÁLLÍTÓ KÉSZLET, TDC (FELSŐHOLTPONT) BEÁLLÍTÓ



Ref.	EAN
10-504	5907558466355

MOTORKERÉKPÁR LÁNCVÁGÓ

FOR CHAIN SIZES:
415, 420
423, 428



Ref.	EAN
10-510	5907558466416

MOTORKERÉKPÁR LÁNCVÁGÓ

FOR CHAIN SIZES:
520, 525
530, 532

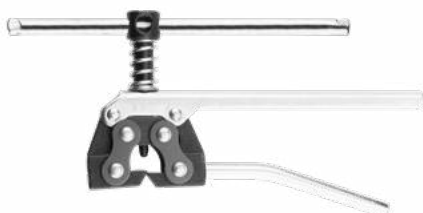

Ref.	EAN
10-511	5907558466423

MOTORKERÉKPÁR ELSŐTENGYEL KULCS

4 AZ 1-BEN



Ref.	EAN
10-502	5907558466331

FOGÓ FÉKDUGATTYÚK KIHÚZÁSÁHOZ



Ref.	EAN
10-507	5907558466386

KAMPÓSKULCS



Ref.	Info	EAN
10-569	16-20mm	5907558466775
10-570	25-28mm	5907558466782
10-571	30-32mm	5907558466799
10-572	34-36mm	5907558466805
10-573	40-42mm	5907558466812
10-574	45-50mm	5907558466829
10-575	52-55mm	5907558466836
10-576	58-62mm	5907558466843
10-577	68-75mm	5907558466850
10-578	80-90mm	5907558466867
10-579	95-100mm	5907558466874
10-580	110-115mm	5907558466881
10-581	120-130mm	5907558466898
10-582	135-145mm	5907558466904
10-583	155-165mm	5907558466911

LÁNC TISZTÍTÓ KEFE, MŰANYAG



Ref.	EAN
10-509	5907558466409

MOTORKERÉKPÁR TENGYELKULCS

3 AZ 1-BEN



Ref.	EAN
10-503	5907558466348

MOTORKERÉKPÁR KÜLLŐKULCSKÉSZLET 9DB



Ref.	EAN
10-508	5907558466393

LÁNCBONTÓ-PRÉSELŐ KÉSZLET



FOR CHAIN SIZES:
520, 525
530, 532

INCLUDES PINS SIZES:
3, 4, 5
mm



Ref.	EAN
10-505	5907558495256

LENGÉSCSILLAPÍTÓ KULCS - SUZUKI

DESIGNATED FOR:
SUZUKI

4mm
5mm
8mm



Ref.	EAN
10-585	5907558466935

LENDKERÉK LEHÚZÓ KÉSZLET, 10DB

CARBON STEEL

+ TRAVEL CASE

10 pcs



Ref.	EAN
10-584	5907558466928

MOBIL HIDRAULIKUS EMELŐ QUADOKHOZ ÉS MOTORKERÉKPÁROKHOZ. TEHERBÍRÁS 680KG



up to 680kg

27 kg

MAX 375 mm H
MIN 115 mm

Ref.	EAN
10-596	5907558467048

KUPLUNGKOSÁR RETESZELŐ ESZKÖZ MOTORKERÉKPÁROKHOZ

∅ 5/9mm



Ref.	EAN
10-587	5907558466959

FÉKHENGERSZERELŐ KÉSZLET

12 adapters

∅ 19-30 mm



Ref.	EAN
10-506	5907558466317

MOTORKERÉKPÁR KORMÁNYFEJ CSAPÁGY SZERELŐ KÉSZLET



Ref.	EAN
10-588	5907558466966

MOTORKERÉKPÁR ELSŐ KERÉKÁLLVÁNY



19" 7-13cm

up to 680kg

Ref.	EAN
10-602	5907558467109

MOTORKERÉKPÁRSZERELŐ KÉSZLET - 25DB - PUHA TOK

CrV steel

x25

1/4"

3/8"



Ref.	EAN
10-500	5907558466317

KERÉCSAPÁGY SZERELŐ KÉSZLET HARLEY-DAVIDSONHOZ

CrV steel

+ TRAVEL CASE

DESIGNATED FOR:
HARLEY DAVIDSON

∅ 25mm
3/4" - 1"

2007-2008 MODELS
ABS/MS-ABS



Ref.	EAN
10-586	5907558466942

STATIKUS MOTORKERÉKPÁR KERÉKIEGYENSÚLYOZÓ ESZKÖZ



14-28 mm AXIS

max 21"

39 kg

Ref.	EAN
10-590	5907558466980

SZERSZÁM MOTORKERÉKPÁR GUMI SZERELÉSÉHEZ

12"-20" 



Ref. EAN
10-606 5907558467147

KÖRNYEZETVÉDELMI SZŐNYEG, 200X100 CM

100x200CM POLYESTER /PVC 5.5kg



Ref. EAN
10-600 5907558499865

DUGÓKULCSKÉSZLET 1/4", 46DB

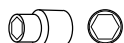

1/4" - 4-4.5-5-5.5-6-7-8-9-10-11-12-13-14 mm



1/4"



1/4" - 50, 150 mm

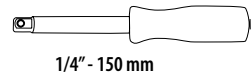

1/4" - 150 mm



1/4"

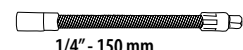

1/4" - 150 mm

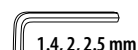

1.4, 2, 2.5 mm

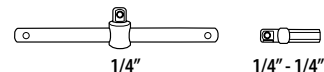

1/4"

1/4" - 1/4"

1/4- SL - 4, 5.5, 7
PH - 1-2-3
PZ - 1-2-3
T - 10-15-20-25-30-40
HEX - 3-4-5-6-7-8

CSAVARHÚZÓ BITKÉSZLET, HAJTÓSZÁRRAL 40DB

S2 steel 3/8" 1/2"
x40
30 mm 75 mm
30 mm 75 mm
30 mm 75 mm



Ref. EAN
06-107 5907558414424

MOTORTAKARÓ PONYVA, 246 X 104 X 127CM, (150 ° C), KÜLTÉRI

246 x104 x127cm 190 T poliester taffeta waterproof resistant to UV150°



Ref. EAN
10-473 5907558471106

MOTORTAKARÓ PONYVA, 220X105X130CM, LÉLEGZŐ, BELTÉRI

220x105x130 cm

black flat fabric



Ref. EAN
10-472 5907558471090

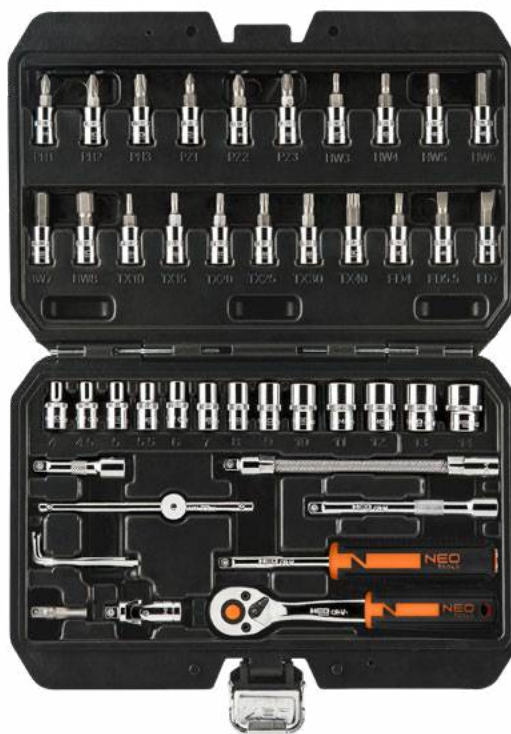

25 years GUARANTEE

TUV Rheinland CERTIFIED

CrV steel

x46 1/4"



NEW PATENTED DESIGN PRECISE 4° 90T

46 elements



Ref. EAN
10-004 5907558465945

DUGÓKULCSKÉSZLET + BITKÉSZLET 1/4" 63DB

1/4" - 4-4.5-5-5.5-6-7-8-9
-10-11-12-13-14 mm

1/4" - 4-4.5-5-5.5-6-7-8-9
-10-11-12-13-14 mm

1/4" - E4-E5-E6-E7-E8-E10

1/4" 1/4"

1/4" - 50; 100; 150 mm

1/4"

1/4", 140 mm

1/4"

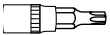

1/4" - TX - 8-10-15-20-25-30-40

PH - 1-2-3

PZ - 1-2-3

SL - 4-5-5-7 mm

HEX - 3-4-5-6-7-8 mm



25 years
GUARANTEE

CrV
steel

x63

1/4"

PRECISE
4°
90T

NEW
PATENTED
DESIGN

63
elements



Ref.	EAN
10-008	5907558466003

DUGÓKULCSKÉSZLET + SZERSZÁMKÉSZLET 1/2", 1/4", 82DB



1/2" - 14-15-16-17-18-19-20-22-24-27-30-32 mm
1/4" - 4-4.5-5-5.5-6-7-8-9-10-11-12-13-14 mm

1/2" - 16, 21 mm

1/2" - 90T
1/4" - 90T

1/4" - 150 mm

1/4" - 150 mm

1/2" 1/2"

1/2" - 125, 250 mm
1/4" - 50, 100 mm

1/4" - 115 mm

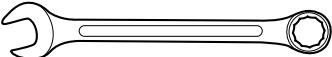

8-10-11-12-13-14-17-19-22 mm

1/2" - 5/16"

1/4" - SL4-SL5,5-SL7
PH1-PH2
PZ1-PZ2
T8-T10-T15-T20-T25-T30
H3-H4-H5-H6

5/16" - SL8-SL10-SL12
PH3-PH4
PZ3-PZ4
T40-T45-T50-T55
H8-H10-H12-H14



25 years
GUARANTEE

TÜV Rheinland
CERTIFIED

CrV
steel

x82

1/4"



1/2"

PRECISE
4°
90T

NEW
PATENTED
DESIGN

82
elements



Ref.	EAN
10-059	5907558487695

DUGÓKULCSKÉSZLET + BITKÉSZLET 1/4", 1/2", 94DB

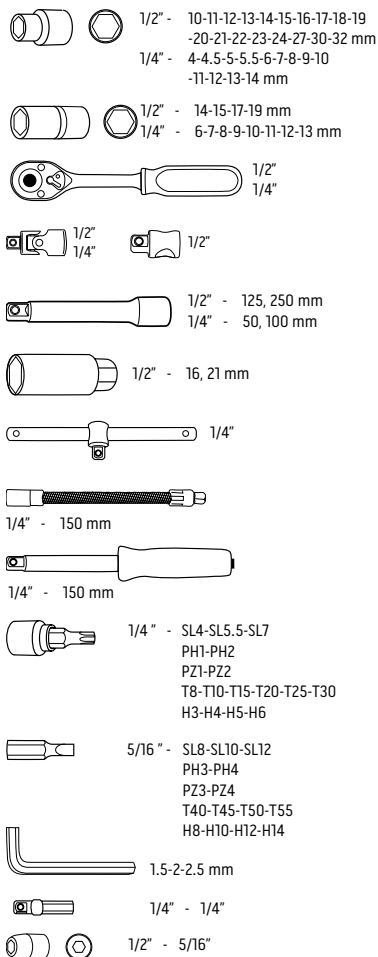

25 years
GUARANTEE

TÜV Rheinland
CERTIFIED

CrV
steel

x94 1/4"



1/2"

PRECISE
4°
90°

NEW
PATENTED
DESIGN

94
elements

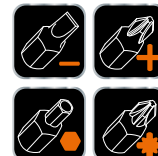

Ref.	EAN
10-062	5907558465952

DUGÓKULCSKÉSZLET + BITKÉSZLET 1/4", 1/2", 110DB

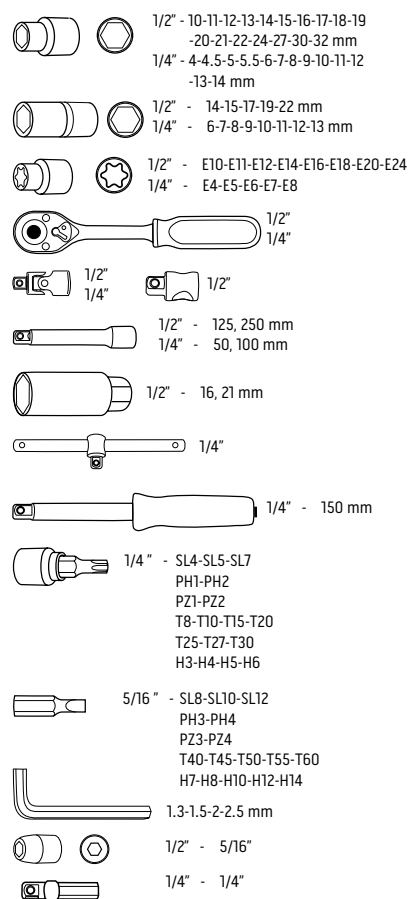

25 years
GUARANTEE

TÜV Rheinland
CERTIFIED

CrV
steel

x110 1/4"



1/2"

PRECISE
4°
90°

NEW
PATENTED
DESIGN

110
elements



Ref.	EAN
10-066	5907558465891

DUGÓKULCSKÉSZLET + SZERSZÁMKÉSZLET 1/4", 3/8", 1/2", 219DB

25 years
GUARANTEE



x219

1/4"

3/8"

1/2"



CrV
steel

PRECISE
4°
90T



219
elements



1/2" - 10-11-12-13-14-15-17-19-20-21-22-24-27-30-32 mm
3/8" - 10-11-12-13-14-15-16-17-18-19 mm
1/4" - 4-4,5-5-5,5-6-7-8-9-10-11-12-13-14 mm



1/2" - 16-17-18-19-22 mm
3/8" - 10-11-12-13-14-15 mm
1/4" - 4-5-6-7-8-9-10 mm



1/2" - E18- E20- E22- E24
3/8" - E8- E10- E12- E14- E16
1/4" - E4- E5- E6- E7- E8

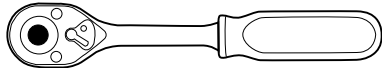

1/2" - 90T; 3/8" - 90T; 1/4" - 90T

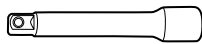

1/2" - 125, 250 mm
3/8" - 125 mm
1/4" - 50, 100 mm

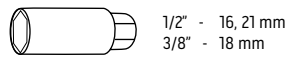

1/2" - 16, 21 mm
3/8" - 18 mm



1/2"
3/8"
1/4"

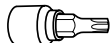

1/2" - T55-T60
1/4" - SL4-SL5.5-SL6.5-SL7
PZ1-PZ2-PZ3, PH1-PH2-PH3
T8-T9-T10-T15-T20-T25-T27-T30
TT8-TT9-TT10-TT15-TT20-TT25-TT27-TT30
H3-H4-H5-H6

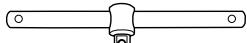

1/4" - 115 mm



1/4" - 210 mm



1/4" - 150 mm

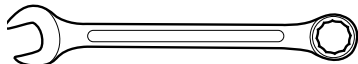

8-9-10-11-12-13-14-15-16-17-18-19 mm



5/16" - T25-T27-T30-T35-T40-T40-T45-T50
H5,5-H6-H7-H8, SL6-SL6,5-SL8
PH3-PH4, PZ3-PZ4, M5-M6-M8-M10



1/4" - H3, H4, H5, H6, H3, H4, H5, H6
PH1, PH2, PZ1, PZ2, T8, T10, T15, T20,
T25, TT10, TT15, TT20, TT25, TT40,
TT8, TT10, TT20, TT25, M5, M6,
M8, SL4, SL5, SL5.5, TRI-WING 1, 2, 3,
TORQ 6, 8, 10, S1, S2, SL4, SL6, SL8



1/2" - 5/16"
3/8" - 5/16"
1/4" - 5/16"



(1,27-1,5-2mm) x 2
2,5-3-4-5 mm

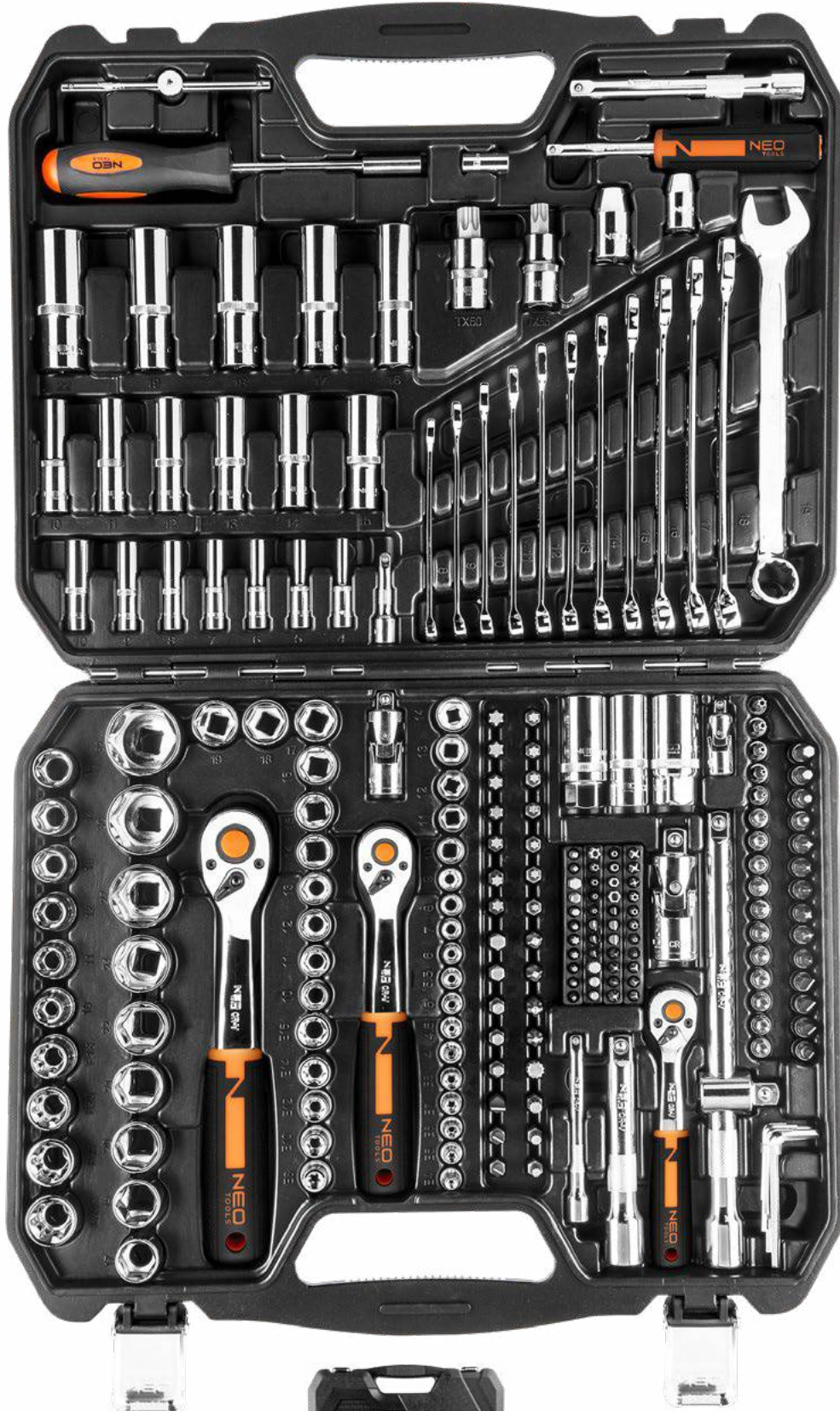

Ref. EAN
10-076 5907558465907

DUGÓKULCSKÉSZLET + SZERSZÁMKÉSZLET 1/4", 3/8", 1/2", 233DB

25 years
GUARANTEE

TÜVRheinland
CERTIFIED

x233

1/4"

3/8"

1/2"



CrV
steel

PRECISE
4°
90T



- 1/2" - 10-13-15-16-17-18-19-20-21-22-23-24-27-30-32 mm
7/16", 1/2", 9/16", 5/8", 11/16", 3/4", 13/16", 7/8"
- 3/8" - 10-11-12-13-14-15-16-17-18-19 mm
- 1/4" - 3.5-4-4.5-5-5.5-6-6.5-7-8-9-10-11-12-13-14 mm
3/8", 11/32", 5/16", 9/32", 1/4", 5/32", 3/16"



233
elements



- 1/2" - 15-16-17-18-19-22 mm
- 3/8" - 10-11-12-13-14-15 mm
- 1/4" - 4-5-6-7-8-9-10 mm

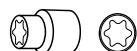

- 1/2" - E16-E18-E20-E22-E24
- 3/8" - E10-E11-E12-E14
- 1/4" - E4-E5-E6-E7-E8

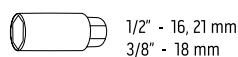

- 1/2" - 16, 21 mm
- 3/8" - 18 mm

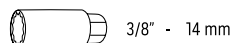

- 3/8" - 14 mm

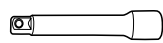

- 1/2" - 125, 250 mm
- 3/8" - 75, 250 mm
- 1/4" - 50, 100 mm



- 9pcs



- 1/4" - 110 mm



- 1/4"



- 1/4"



- 1/4"

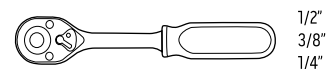

- 1/2"
- 3/8"
- 1/4"

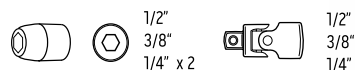

- 1/2"
- 3/8"
- 1/4" x 2
- 1/2"
- 3/8"
- 1/4"



- 1/2"
- 3/8"



- 1/4" x 1/4"
- 1/4" x 3/8"

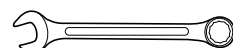
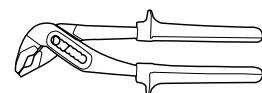

- 8-9-10-11-12-13-14-15-17-19-22 mm



- L=75mm
- 8pcs



- 5/16" L=30mm
- 24pcs



- L=25mm
- 60pcs



Ref.	EAN
10-078	5907558465914

SZERSZÁMKÉSZLET 143DB

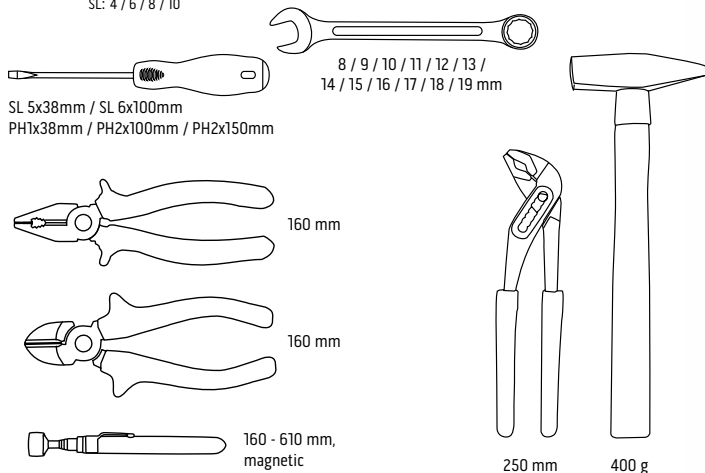
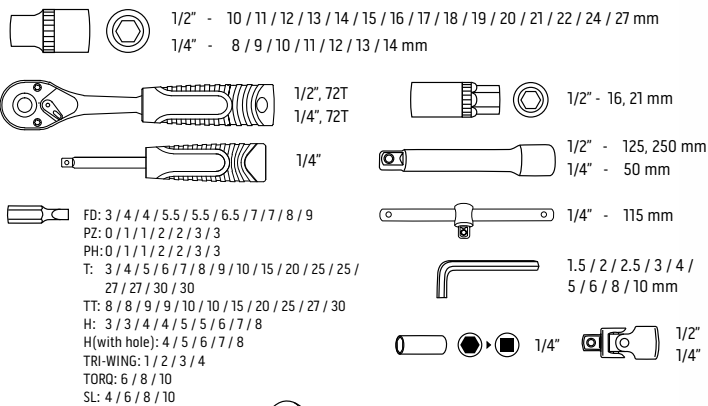

DUGÓKULCS KÉSZLET, ÁTMENŐ RACSNIS HAJTÓKAROKKAL, 1/4"- 3/8", 46 DB

Ref. EAN
08-945 5907558452969

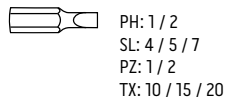
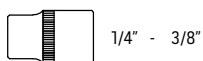
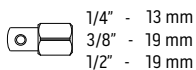
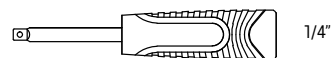
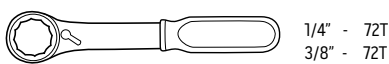
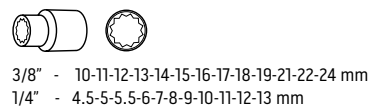

Ref. EAN
10-019 5907558452969

IMBUSZKULCS KÉSZLET 9DB HOSSZÚ 1.5-10MM, SZÍNES



Ø [mm]	L [mm]	L ₁ [mm]
1.5	91	16
2.0	103	19
2.5	115	20
3.0	130	23
4.0	145	29
5.0	166	35
6.0	188	38
8.0	208	43
10.0	230	50



Ref.	EAN
09-512	5907558403428

BITFEJES CSAVARHÚZÓ KÉSZLET, 13DB

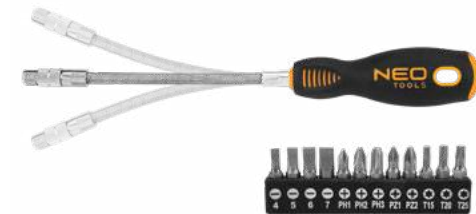

Ref.	EAN
04-215	5907558483918

RACSNIS HOSSZÚ CSILLAGKULCS KÉSZLET 6DB, 8-19MM



Ref.	Info	EAN
09-370	8, 10, 13, 16, 17, 19 mm	5907558483109

TORXKULCS KÉSZLET, T10-50, 9DB, SZÍNES



	L [mm]	L ₁ [mm]
T10	89	20
T15	105	22
T20	115	23
T25	130	25
T27	146	30
T30	167	35
T40	184	38
T45	204	45
T50	226	50



Ref.	EAN
09-518	5907558420661

CSILLAG-VILLÁSKULCS KÉSZLET 6-22MM, 12DB



Ref.	Info	EAN
09-752	6-22 mm	5907558411539

RACSNIS CSILLAG-VILLÁSKULCS KÉSZLET 12DB, 8-19MM



Ref.	Info	EAN
09-345	8, 9, 10, 11, 12, 13, 14, 15, 16, 17, 18, 19 mm	5907558483093

CSAVARHÚZÓ KÉSZLET + BITEK 37DB



Ref.	EAN
04-210	5907558422160

VILLÁSKULCS KÉSZLET 8DB, 5.5 - 27MM, SZUPER VÉkony KIVITEL, ÖSSZEHAJTHATÓ TOKBAN



Ref.	Info	EAN
09-860	5,5x7, 8x9, 10x12, 11x13, 14x17, 19x21, 22x23, 24x27 mm	5907558458916

ÜTVECSAVARÓZÓ KÉSZLET, 1/2", 10DB



Ref.	EAN
04-250	5907558410082

TORXBIT KÉSZLET, 49DB

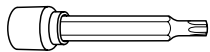

H6, H7, H8, H10, H12
T25, T30, T40, T45, T50, T60
M6, M8, M10, M12, M14



T20, T25, T27, T30,
T40, T45, T50, T60

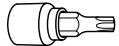

H5, H6, H7, H8, H10, H12, H14, H17, H19
T20, T25, T27, T30, T40, T45, T50, T55, T60, T70
M5, M6, M8, M10



Ref.	EAN
08-713	5907558420180

DUGÓKULCSKÉSZLET, SÉRÜLT FEJŰ CSAVAROKHOZ 16DB 1/2", 8, 10, 11, 12, 13, 14, 15, 16, 17, 19, 21, 22, 24, 27MM



Ref.	EAN
11-920	5907558436914

ÁLLÍTHATÓ CSILLAGKULCS



Ref.	Info	EAN
03-030	5-16mm	5907558445268
03-031	5-27 mm	5907558445275

S2
steel

CrV
steel

1/2"

x49



NYOMATÉKKULCS KÉSZLET, "DOUBLE - CLICK", 3DB: 1/4"(5-25 NM), 3/8"(20-100 NM), 1/2"(65-350 NM)



x3 1/4" 3/8"
1/2" 72 T L/R
5-25 Nm 20-120 Nm 60-330 Nm

Ref.	EAN
08-845	5907558463538

ZESTAW KLUCZY DYNAMOMETRYCZNYCH TORQUE WRENCH SET

x3 1/4" 3/8" 1/2" 72 T L/R
5-25 Nm 20-100 Nm 65-350 Nm



Ref.	EAN
08-843	5907558471175

DUGÓKULCSKÉSZLET SÉRÜLT FEJŰ CSAVAROKHOZ, 3/8", 11DB



Ref.	EAN
11-922	5907558436938

ZÉGERGYŰRŰ FOGÓ KÉSZLET 4DB, CRMO, 170-180MM, 40 - 100MM

x4 CrV steel



Ref.	EAN
01-097	5907558463606

GYŰJTÓGYERTYAKULCS 3/8"

3/8" 90 mm



Ref.	Info	EAN
11-152	14 mm	5907558417166
11-153	16 mm	5907558417173

RACSNIS KULCS 1/2", 90 FOG, T-1000,



Ref.	EAN
10-300	5907558467338

ÁLLÍTHATÓ VILLÁSKULCS, CSAVARKULCS



Ref.	L[mm]	Ra[mm]	EAN
03-015	150	0-34	5907558412208
03-014	200	0-38	5907558404159
03-016	250	0-50	5907558412215

**TÖRTCSAVAR-KIHAJTÓ KÉSZLET,
NÉGYSZÖG VÉG, VEZETŐFÚRÓKKAL,
10DB, 2-14MM (M3-M18)**

25
years
GUARANTEE

TÜVRheinland
CERTIFIED

CrMo
steel

x10



Ref.	EAN
09-609	5907558416503

MENETJAVÍTÓ KÉSZLET

CrV
steel



Ref.	info	EAN
11-901	M6	5907558419870
11-902	M8	5907558419887
11-903	M10	5907558419894
11-904	M12	5907558419900

MENETJAVÍTÓ BETÉT



Ref.	info	info	EAN
11-905	M5	20	5907558419917
11-906	M6	20	5907558419924
11-907	M8	20	5907558419931
11-908	M10	20	5907558419948
11-909	M12	10	5907558419955

**TÖRTCSAVAR-KIHAJTÓ KÉSZLET, 5DB,
NÉGYSZÖG VÉG, 2-14MM (M3-M18)**

25
years
GUARANTEE

TÜVRheinland
CERTIFIED

CrMo
steel

x5



Ref.	EAN
09-615	5907558416497

MENETKÉSZÍTŐ KÉSZLET, 110DB

x110

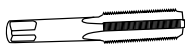

M2x0,4; M3x0,5; M4x0,7; M5x0,8;
M6x0,75; M6x1,0; M7x0,75; M7x1,0;
M8x0,75; M8x1,0; M8x1,25; M9x0,75;
M9x1,0; M9x1,25; M10x0,75; M10x1,0;
M10x1,25; M10x1,5; M11x0,75;
M11x1,0; M11x1,25; M11x1,5;
M12x0,75; M12x1,0; M12x1,25;
M12x1,5; M12x1,75; M14x1,0;
M14x1,25; M14x1,5; M14x2,0; M16x1,0;
M16x1,5; M16x2,0; M18x1,5;

M2x0,4; M3x0,5; M4x0,7; M5x0,8;
M6x0,75; M6x1,0; M7x0,75; M7x1,0;
M8x0,75; M8x1,0; M8x1,25; M9x0,75;
M9x1,0; M9x1,25; M10x0,75; M10x1,0;
M10x1,25; M10x1,5; M11x0,75;
M11x1,0; M11x1,25; M11x1,5;
M12x0,75; M12x1,0; M12x1,25;
M12x1,5; M12x1,75; M14x1,0;
M14x1,25; M14x1,5; M14x2,0; M16x1,0;
M16x1,5; M16x2,0; M18x1,5

Ref.	EAN
11-915	5907558436907

HÉZAGMÉRŐ KÉSZLET

STAINLESS
steel

65
Mn

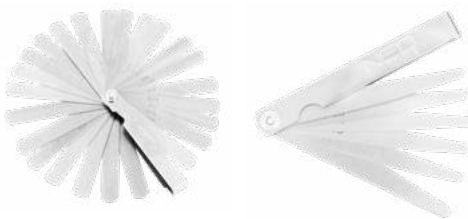

Ref.	Info	EAN
11-190	0.04-0.63 mm	5907558452433
11-191	0.05-1.0 mm	5907558452440

CSAPÁGYSZERELŐ KÉSZLET, 51DB

18-65
mm



Ref.	EAN
11-691	5907558436631

CSAPÁGYLEHÚZÓ, HÁROMKÖRMÖS



Ref.	Info	EAN
11-868	1"	5907558420128
11-869	2"	5907558420135
11-870	3"	5907558420142

CSAPÁGYLEHÚZÓ, KÉTKÖRMÖS, MINI



Ref.	Info	EAN
11-871	1"	5907558420159
11-872	2"	5907558420166
11-873	3"	5907558420173

HÉZAGMÉRŐ KÉSZLET

STAINLESS
steel

65
Mn



Ref.	Info	EAN
11-192	0.127 - 0.508 mm	5907558452457

TOLÓMÉRŐ 150MM, ROZSDAMENTES, DIN862



Ref.	L [mm]	Ra [mm]	EAN
75-001	230	0-150	5907558409468

SATU 125MM, 10,5KG, FORGATHATÓ



Ref.	W [mm]	Ra [mm]	EAN
35-012	125	124	5907558400779

OLAJ ÉS HŰTŐFOLYADÉK LEERESZTŐ TÁL, 7 L

7L



Ref.	Info	EAN
11-550	7l	5907558415360

OLAJ ÉS HŰTŐFOLYADÉK LEERESZTŐ TÁL, 16 L

PE

16L



Ref.	Info	EAN
10-800	16l	5907558495799

GUMIKALAPÁCS 58MM 450G FEKETE FEHÉR



Ref.	m [g]	ø [mm]	EAN
25-067	450	58	5907558440133

OLAJSZŰRŐ LESZEDŐ FOGÓ (30° / 60° / 90°), 63.5 - 116MM



Ref.	EAN
11-241	5907558435948

OLAJSZŰRŐ KULCS LÁNCOS 1/2" 60-115MM



Ref.	Ra [mm]	EAN
11-381	60-115	5907558445459

OLAJ ÉS HŰTŐFOLYADÉK LEERESZTŐ KANNA, HORDOZHATÓ, ZÁRT, 12L



Ref.	Info	EAN
10-801	10l	5907558495805

DRÓTKEFE KÉSZLET 3DB, 3X7 SOR, ACÉL, MŰANYAG ÉS SÁRGARÉZ SZÁLAS KEFÉK



Ref.	EAN
39-100	5907558452686

OLAJSZŰRŐ LESZEDŐ KULCS (64-100MM)



Ref.	Ra [mm]	EAN
11-239	64-100	5907558435924

MŰANYAG FOLYADÉKBETÖLTŐ FECSKENDŐ



Ref.	Info	EAN
10-805	200 ml	5907558495843
10-806	500 ml	5907558495850
10-807	1500 ml	5907558495867



**UNIVERZÁLIS TÖLCSÉR 125MM,
RÖGZÍTŐ KONZOLLAL**



Ø125MM
DEPTH
250MM
HANDLE
INCLUDED

Ref.	EAN
10-808	5907558499810

**OLAJ ÉS HŰTŐFOLYADÉK BEÖNTŐ KANNA,
FLEXI CSŐVEL, 1L**



PE

Ref.	Info	EAN
10-802	1l	5907558495812
10-803	3l	5907558495829
10-804	5l	5907558495836

**MÁGNESES TÁL, FERDE,
ÁTMÉRŐ 150 MM**



Ø15CM
DEPTH
112MM
MAGNET

Ref.	EAN
11-617	5907558499834

**ÜZEMANYAGKANNA, MŰANYAG(HDPE),
KIÖNTŐVEL**



HDPE
PP
LDPE

Ref.	Info	EAN
11-560	10l	5907558436402
11-561	20l	5907558436419

**RUGALMAS SZILIKON TÖLCSÉR,
ÖSSZECSUKHATÓ, 11X14CM**



FOLDABLE
DIMENSIONS:
10.5 X
14.5 CM
SILICONE
MATERIALS

Ref.	EAN
10-809	5907558499827

PNEUMATIKUS SPIRÁLTÖMLŐ

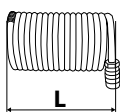

Pu
MAX
8BAR
+35°C
-10°C



Ref.	L [m]	⌀ [mm]	⌀ [mm]	EAN
12-070	5	6,5	10,0	5907558414448
12-071	10	6,5	10,0	5907558414455
12-072	15	6,5	10,0	5907558414462
12-074	5	8,0	12,0	5907558414479
12-075	10	8,0	12,0	5907558414486
12-076	15	8,0	12,0	5907558414493

**PNEUMATIKUS TÖMLŐDOB, AUTOMATA,
KOMPOZIT, 9.5MM X 15M**

15m
9.5mm
1/4"
20 BAR
hybrid
material
PVC +
RUBBER



Ref.	Info	EAN
10-700	9.5 mm x 15 m	5907558497359

**KOMPRESSZOR, 12L, EXTRA CSENDES,
KEFEMENTES MOTORRAL, OLAJMENTES,
79(61)DB**



12L
500W
230V ~
50Hz
MAX 8 BAR
95
L/min
79dB
QUIET
OPERATION

Ref.	EAN
12K020	5907558453676

**KOMPRESSZOR, 24L, EXTRA CSENDES,
KEFEMENTES MOTORRAL, OLAJMENTES,
79(61)DB**



24L
800W
230V ~
50Hz
MAX 8 BAR
125
L/min
79dB
QUIET
OPERATION

Ref.	EAN
12K021	5907558453683

**KOMPRESSZOR, 50L, EXTRA CSENDES,
KEFEMENTES MOTORRAL, OLAJMENTES,
79(61)DB**



50L
1150W
230V ~
50Hz
MAX 8 BAR
180
L/min
79dB
QUIET
OPERATION

Ref.	EAN
12K022	5907558453690

**PNEUMATIKUS ÜTVECSAVARÓZÓ,
1/2", 1300NM**



Ref.	EAN
14-006	5907558442557

**KERÉKFŰVATÓ PISZTOLY
NYOMÁSMÉRŐVEL**



Ref.	EAN
14-714	5907558452150

**KERÉKFŰVATÓ PISZTOLY
NYOMÁSMÉRŐVEL**



Ref.	EAN
14-718	5907558452174

**PNEUMATIKUS RACSNIS KULCS
1/2", 88 NM**



Ref.	EAN
14-012	5907558442588

**PNEUMATIKUS LEFŰVÓPISZTOLY
KEFÉVEL**



Ref.	EAN
14-036	5907558469035

TÖMÍTÉS KÉSZLET, 419DB

x419

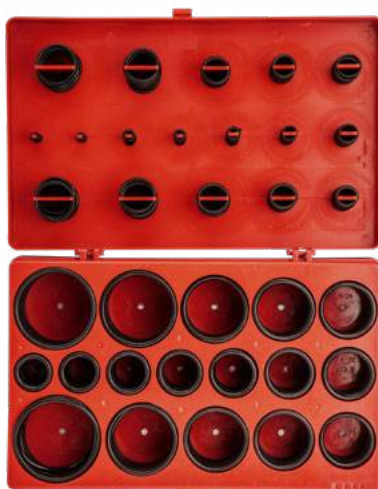

Ref.	EAN
11-983	5907558435788

PNEUMATIKUS LEFŰVÓPISZTOLY



Ref.	Info	EAN
14-708	-	5907558452129
14-710	83	5907558452136
14-712	220	5907558452143

**RÉZ ALÁTÉT KÉSZLET,
300DB**

x300 Cu

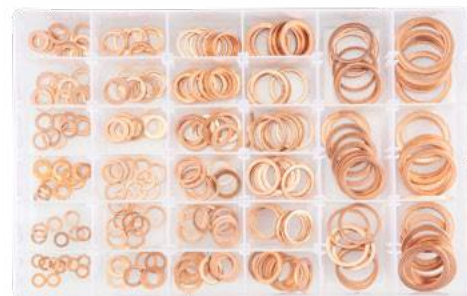

Ref.	EAN
11-971	5907558437133

TÖMLŐBILINCS KÉSZLET, 34DB

x34

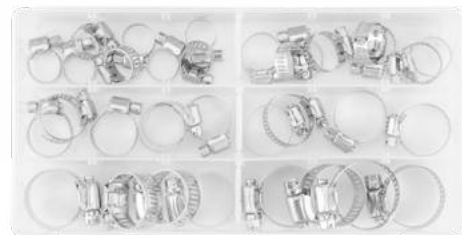

Ref.	EAN
11-981	5907558435764

KÁBELKÖTEGELŐ, GYORSKÖTŐZŐ



Ref.	Color	W [mm]	L [mm]	N	EAN
01-600		2.5	100	100	5907558468007
01-601		2.5	200	100	5907558468014
01-602		2.5	200	100	5907558468021
01-604		3.6	300	100	5907558468045
01-605		2.5	100	100	5907558468052
01-606		3.6	200	100	5907558468069
01-607		4.8	200	75	5907558468076
01-609		4.8	300	75	5907558468090
01-611		4.8	370	75	5907558468113
01-612		4.8	370	75	5907558468120
01-613		7.6	500	75	5907558468137
01-614		7.6	500	75	5907558468144

GÁZFORRASZTÓ, PERZSELŐ, GÁZÉGŐ



PIEZO
1.2 kW
87 g/h
FOR 190g CARTRIDGE

Ref.	info	T [°C]	q [g/h]	P [kW]	EAN
20-022		1350	87	1.2	5907558455168
20-045	+ 4 x 20-033	1350	87	1.2	5907558488265

TÖRHETŐ PENGÉS KÉS 18MM, FÉM VEZETŐSÍN



Ref.	info	EAN
63-011	18 mm	5907558410440

AUTÓMATA AKKUTÖLTŐ 2A / 35W, 4-60AH, SAVAS/AGM/ZSELÉS AKKUMULÁTOROKHOZ



Ref.	EAN
11-890	5907558463279

AUTOMATIKUS AKKUMULÁTORTÖLTŐ SAVAS / AGM / GEL AKKUMULÁTOROKHOZ



Ref.	[A/W]	Ah	EAN
11-891-1	4/70	3-120	5907558495126
11-892-1	6/100	3-150	5907558495126

HŐLÉGFÚVÓ 2000W, HŐFOKSZABÁLYZÓS I: 50°C, II: 70-600°C



Ref.	EAN
04-710	5907558470550

MULTIMÉTER DIGITÁLIS, AC V, DC V, AC A, DC A, ELLENÁLLÁS, HŐMÉRŐ



Ref.	EAN
94-004	5907558469523

INFRA HŐMÉRŐ, 50-880 C, FOLYADÉK, LEVEGŐ, TEST



Ref.	EAN
75-276	5907558481778

FORRASZTÓPISZTOLY, 200W, TARTOZÉKOKKAL KOFFERBEN



Ref.	EAN
19-152	5907558472059

PRECÍZIÓS OLDALCSÍPŐ ÉS KÁBELCSUPASZÍTÓ FOGÓ 140MM



Ref.	L [mm]	Ø [mm]	EAN
01-509	140	0,8 - 2,6	5907558439281

SZIGETELŐSZALAG



Ref.	info	color	EAN
01-528	15 mm x 0.13 mm x 10m		5907558439335
01-526	15 mm x 0.13 mm x 10m		5907558439311

UNIVERZÁLIS JAVÍTÓ RAGASZTÓSZALAG (DUCT TAPE) 48MMX20M



Ref.	info	EAN
56-040	48 mm x 20 m	5907558446463

ZSEBLÁMPA, TÖLTHETŐ, 2 FUNKCIÓS USB 300LUM, CREEPE + COB LED, 3W



Ref.	EAN
99-034	5907558451443

FEJLÁMPA + ZSEBLÁMPA 2AZ1-BEN, TÖLTHETŐ, USB 2000LUM

CREE XHP50.2 LED, 20W

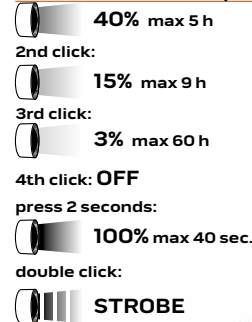

Ref.	EAN
99-029	5907558451276

FEJLÁMPA, TÖLTHETŐ USB 180LUM COB LED + MOZGÁSÉRZÉKELŐVEL

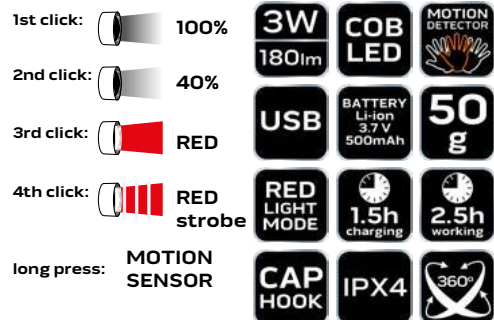

Ref.	EAN
99-069	5907558464931



AKKUS MŰHELY-VIZSGÁLÓLÁMPA, TÖLTHETŐ, 200LUM COB LED, 3W

- 1st click:
100% max 1.5 h
- 2nd click:
50% max 3 h
- 3rd click:
100% max 3 h
- 4th click: OFF
- press 2 seconds:
RED LIGHT max 3 h
- + click 1:
RED STROBE
- + click 2: OFF



Ref.	EAN
99-041	5907558452327

AKKUS REFLEKTOR, TALPAS, TÖLTHETŐ, 750 + 250LUM COB LED, POWERBANK FUNKCIÓ, 10W

- 1st click:
Large LED 100% max 2 h
- 2nd click:
Small LED 100% max 5 h
- 3rd click: OFF
- press 3 seconds:
Both LEDs 100% max 2 min



Ref.	EAN
99-040	5907558452310

MŰHELY-VIZSGÁLÓLÁMPA 10W, 900LUM SMD, 5M KÁBEL

- 1st click:
100% max 2h
- 2nd click:
30% max 7h
- 3rd click:
OFF



Ref.	EAN
99-044	5907558452358

RAKÁSOLHATÓ SZERSZÁMLÁDA KÉSZLET, 3DB, ÖSSZESEN 78LITER, SYSTEM II.



Ref.	L x W x H [mm]	EAN
84-066	530 x 380 x 690	5907558450118

REFLEKTOR, TALPAS 230V/50W, 4500LUM, SMD LED



Ref.	EAN
99-063	5907558452600

SZERSZÁMKOCSI, MŰANYAG, 495X360X710MM



Ref.	L x W x H [mm]	EAN
84-115	495 x 360 x 710	5907558421682

**SZERSZÁMOSLÁDA, SZERSZÁMLÁDA 18",
460X255X240MM, 2 SZORTIMENTER**



Ref.	Info	EAN
84-102	18"	5907558409574

MŰSZAKI OLLÓ, 230MM, 6 AZ 1-BEN



Ref.	L [mm]	EAN
64-001	230	5907558485462



SZERSZÁMTÁLCA, SZILIKON



MADE OF
STRONG
TPR
SILICONE

Ref.	Info	EAN
10-480	27.5x14.5x2.5 cm	5907558471137
10-481	25.7x23.2x2.5 cm	5907558471144
10-482	54x35x2.9 cm	5907558471151

**KEMPING FŰTŐ- HŰTŐLÁDA, 230V/12V,
26 LITER, 405 X 320 X 430MM**



Ref.	EAN
63-152	5907558469516

TÉRKŐ-, BETON-, JÁRDASEPRŰ, FÉM NYÉLBEFOGÓ, PROFI KIVITEL



Ref.	L [cm]	EAN
39-200	30	5907558468212
39-201	40	5907558468229
39-202	50	5907558468236
39-203	60	5907558468243
39-204	80	5907558468250

PARTVIS-, SEPRŰNYÉL, DIA. 24 FI, LAKKOZOTT



Ref.	L [cm]	EAN
39-250	120	5907558468267
39-251	150	5907558468274

**PADLÓVENTILÁTOR 100W,
ÁTMÉRŐ 45CM, 3 SEBESSÉGFOKOZA**



- 100W
- Ø 45 CM
- 3 AIRFLOW SPEEDS
- METAL BODY
- COPPER MOTOR

Ref.	EAN
90-010	5907558466232

**KÉZTISZTÍTÓ PASZTA 4 L, RAGASZTÓ,
GYANTA, SZILIKON, LAKK, FESTÉK,
POLIURETÁN HAB ÉS POLIMER**

4.0L



Ref.	Kolor	EAN
10-402		5907558467161
10-404		5907558467185
10-406		5907558467208

**MUNKAKESZTYŰ, PERFORÁLT NITRIL,
NARANCSÁRGA, 50DB**

- PERFORATED NITRILE
- LATEX FREE
- 100% NITRILE SILICONE FREE
- x50 pcs by weight
- SERVICE & REPAIR
- POWDER FREE
- BUILDING & CONSTRUCTION
- R&D



Ref.	Info	EAN
97-690-M	x50, M	5907558484489
97-690-L	x50, L	5907558484496
97-690-XL	x50, XL	5907558484502



**KÉZ-ÉS FELÜLETTISZTÍTÓ
CSISZOLÓKENDŐ, 75 LAP, RAGASZTÓ,
GYANTA, SZILIKON, LAKK, FESTÉK,
POLIURETÁN HAB ÉS POLIMER**



- STRENGTH
- 75 PCS
- 20x21 cm
- WORKING
- WORKING

Ref.	EAN
10-408	5907558467222

**MUNKAKESZTYŰ, PERFORÁLT NITRIL,
FEKETE, 100DB**

- PERFORATED NITRILE
- LATEX FREE
- 100% NITRILE SILICONE FREE
- x100 pcs by weight
- SERVICE & REPAIR
- POWDER FREE
- BUILDING & CONSTRUCTION
- R&D



Ref.	Info	EAN
97-691-M	x100, M	5907558484519
97-691-L	x100, L	5907558484526
97-691-XL	x100, XL	5907558484533

**KÉZTISZTÍTÓ KENDŐ, 100 LAP,
RAGASZTÓ, GYANTA, SZILIKON, LAKK,
FESTÉK, POLIURETÁN HAB ÉS POLIMER**



- STRENGTH
- 100 PCS
- 20x25 cm
- WORKING
- WORKING

Ref.	EAN
10-407	5907558467215

MÁGNESES MUNKAKESZTYŰ 10"

10"



Ref.	size	EAN
GD013	10"	5907558462401



Böngésszen a NEO TOOLS közösségi média csatornáin!



@NEOTOOLS



@NEOTOOLSOFFICIAL

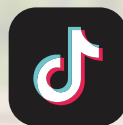

NEOmov

