

**NEO**  
TOOLS  
**GRAPHITE**



**KATALOG**  
**2023**

**ELEKTRO / ELECTRIC / ЭЛЕКТРО**

## NEO to...

- wysokiej klasy specjalistyczne i popularne narzędzia dla profesjonalistów i wymagających użytkowników
- najnowsze technologie i materiały wykorzystywane w produktach
- 25 lat gwarancji\* jakości i niezawodności

## NEO is...

- high-quality specialist and popular tools for professionals and demanding users
- state-of-the-art technologies and materials used in the products
- excellent quality and reliability confirmed by 25 years warranty\*

## NEO это...

- высококлассные специализированные и популярные инструменты для профессионалов и требовательных пользователей
- продукты изготовлены с использованием новейших технологий и материалов
- 25 лет гарантии\* качества и надежности, подтвержденной независимыми экспертами



**Zapraszamy na kanały marki NEO w mediach społecznościowych**

**Come and browse NEO social media channels**

**Приглашаем на каналы марки NEO**

**в социальных сетях**



@NEOTOOLS



@NEOTOOLSOFFICIAL



VIDEO CONTENT

NEOmov



Informacje o nowościach produktowych, porady oraz VIDEO

Information on new products, advice and VIDEOS

Информация о новых продуктах, советы и ВИДЕО

VIDEO produktowe, porównania i testy produktów w wielu wersjach językowych

Product related VIDEOS, product comparisons and tests in multiple language versions

ВИДЕО о продуктах, сравнение и тесты продуктов в различных языковых версиях

**NEO**  
TOOLS



\* 25 lat gwarancji oraz certyfikat TÜV M+T (Monitoring + Testing) posiadają wybrane produkty NEO – szczegóły na stronie neo-tools.com

\* Selected NEO products feature a 25-year warranty and a TÜV M+T (Monitoring + Testing) certificate – you can find details at neo-tools.com

\* Некоторые товары NEO имеют 25-летнюю гарантию и сертификат TÜV M+T (Monitoring + Testing) – подробная информация доступна на сайте neo-tools.com



## NEO ELEKTRYCY

Bezpieczeństwo w pracach instalatorskich to podstawa, dlatego narzędzia NEO dla elektryków posiadają certyfikat VDE zaświadcający o zgodności z wymogami norm dotyczących prac pod napięciem. Wysoką jakość NEO potwierdza również certyfikat TÜV M+T oraz 25-letnia gwarancja na wybrany asortyment.

## NEO ELECTRICIANS

The safety in installation works is the basis. Therefore, NEO tools for electricians are certified to VDE, which ensures consistency with requirements of standards regarding works on live voltage. The high quality of NEO is also confirmed with the certificate TÜV M+T and 25-year warranty on the selected assortment.

## NEO ЭЛЕКТРИКИ

Безопасность при монтажных работах – это чрезвычайно важно, поэтому инструмент NEO для электриков имеет сертификат VDE, который подтверждает соответствие изделия стандартам, применительным к электротехнической продукции. Высокое качество NEO подтверждает также сертификат TÜV M+T и 25-летний гарантийный срок на избранный ассортимент.

## Cechy produktów NEO ELEKTRYCY:

- certyfikat VDE\*
- certyfikacja TÜV M+T\*
- 25 lat gwarancji\*
- ergonomiczne dwumateriałowe uchwyty
- zastosowanie stali CrV i S2 do metalowych elementów
- szeroki asortyment produktów

\*na wybrany asortyment

## Features of the NEO ELECTRICIANS products:

- VDE certificate\*
- TÜV M+T certificate\*
- 25-year warranty\*
- ergonomic dual-material handles
- application of CrV and S2 steel for metal elements
- wide range of products

\*for selected products

## Характеристика инструмента NEO ДЛЯ ЭЛЕКТРИКОВ:

- сертификат VDE\*
- сертификат TÜV M+T\*
- гарантия 25 лет\*
- эргономичные двухкомпонентные рукоятки
- металлические элементы выполнены из стали CrV и S2
- широкий ассортимент

\*на избранный ассортимент





**3**  
**YEARS**  
**WARRANTY**



Marka GRAPHITE zapewnia pełną dostępność części zamiennych oraz materiałów eksploatacyjnych dla urządzeń i elektronarzędzi.

We ensure constant availability of spare parts and consumable materials for devices and power tools.

Обеспечиваем постоянную доступность запасных частей и расходных материалов для оборудования электроинструмента.

**GRAPHITE**  
**POWER IN YOUR HANDS**



3 lata gwarancji na WSZYSTKIE elektronarzędzia, urządzenia, akumulatory i ładowarki marki GRAPHITE. Regulamin dostępny na [graphite.pl](http://graphite.pl)  
3-year warranty on all power tools, devices, batteries and chargers. Terms and conditions are available on [en.graphite.pl](http://en.graphite.pl)  
Гарантия распространяется на все электроинструменты GRAPHITE, включая батареи. Подробная информация доступна на сайте [ru.graphite.pl](http://ru.graphite.pl)

# GRAPHITE **POWER IN YOUR HANDS**

## GRAPHITE to

- ▶ szeroki asortyment wysokiej jakości elektronarzędzi oraz akcesoriów przeznaczonych do intensywnego użytkowania, przy obciążeniach bliskich profesjonalnym
- ▶ produkty z optymalnym zestawem cech: wytrzymałe, o mocnych silnikach, ergonomicznie zaprojektowane
- ▶ gwarancja efektywnie wykonanej pracy i dobrze wydanych pieniędzy

## GRAPHITE is...

- ▶ a wide range of high quality power tools and accessories designed for intensive semi-professional use
- ▶ products with optimum set of features: durable, with powerful motors and ergonomically designed
- ▶ a guarantee of job well done and money well invested

## GRAPHITE это...

- ▶ широкий ассортимент высококачественных электроинструментов и аксессуаров, предназначенный для интенсивного использования при нагрузках, приближенных к профессиональным
- ▶ продукты с оптимальным набором качеств: прочные, с мощными двигателями и эргономичной конструкцией
- ▶ гарантия достижения запланированных результатов и хорошего вложения денег

**Zapraszamy na kanały marki GRAPHITE w mediach społecznościowych**

**Come and browse GRAPHITE social media channels**

**Приглашаем на каналы марки GRAPHITE в социальных сетях**



GRAPHITE



Informacje o nowościach produktowych, porady oraz VIDEO

Information on new products, advice and VIDEOS

Информация о новых продуктах, советы и ВИДЕО

 YouTube  
GRAPHITEmov



VIDEO produktowe, porównania i testy produktów w wielu wersjach językowych

Product related VIDEOS, product comparisons and tests in multiple language versions

ВИДЕО о продуктах, сравнение и тесты продуктов в различных языковых версиях



**108**  
ELEMENTS

1/2" - 15-16-17-19-20-21-22-24-27-30-32 mm  
1/4" - 4-4.5-5-5.5-6-7-8-9-10-11-12-13-14 mm

1/2" - E20-E22-E24  
3/8" - E10-E11-E12-E14-E16-E18  
1/4" - E4-E5-E6-E7-E8

1/2" - T2T  
1/4" - T2T

1/2" - T25, 250 mm  
1/4" - 50, 100 mm

1/2" - 16, 21 mm

1/4" - 115 mm

1/4" - 150 mm

1000V  
SL 5.5x125, SL 3x100mm  
PH0x60mm, PH1x80mm  
PH2x100mm

250 V **CE**

160 mm

1000V, 160 mm

1000V, 160 mm

190 mm

1/2"

1/2"  
1/4"

3/8" x 1/2"  
1/2" x 3/8"  
1/2" x 5/16"

1/4" - 5-5.5-6-7-8-9-10  
11-12-13 mm

25 mm - PH1, PH2, PH2, PH3,  
P21, P22, P22, P23,  
SL3, SL4, SL5, SL6,  
T10, T15, T20, T25, T27,  
T30, T40,  
TT10, TT15, TT20, TT25,  
TT27, TT30, TT40,  
H3, H4, H5, H6

0.34-6 mm<sup>2</sup>

0.25-6 mm<sup>2</sup>

0.5-6 mm<sup>2</sup>

0.5-16 mm<sup>2</sup>



Ref.		EAN
01-310	0/2	5907558431957

**NEO**  
TOOLS

**25**  
years  
GUARANTEE

**TÜVRheinland**  
CERTIFIED

\*25 lat gwarancji oraz certyfikat TÜV M+T (Monitoring + Testing) posiadają wybrane produkty NEO – szczegóły na stronie neo-tools.com  
\*Selected NEO products feature a 25-year warranty and a TÜV M+T (Monitoring + Testing) certificate – you can find details at neo-tools.com  
\*Некоторые товары NEO имеют 25-летнюю гарантию и сертификат TÜV M+T (Monitoring + Testing) – подробная информация доступна на сайте neo-tools.com

SKRZYŃNIA SERWISOWA ELEKTRYKA / ELECTRICIAN'S TOOL BOX / СЕРВИСНЫЙ ЯЩИК ЭЛЕКТРИКА



25 years  
GUARANTEED

S2  
steel

CrV  
steel

1000V

1/2"

x52

EVA

PP  
POLYPROPYLEN

36

DUST  
WATER

IP67

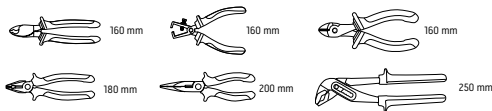

1000V  
CrV  
steel

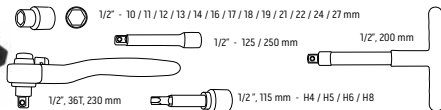

1/2" CrV  
steel 1000V  
36

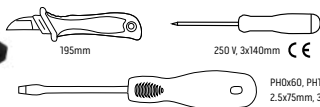

1000V  
S2  
steel

PH0x60, PH1x80, PH2x100, PH3x150  
Z.5x75mm, 3x100mm, 4x100mm, 5.5x125mm, 6.5x150mm

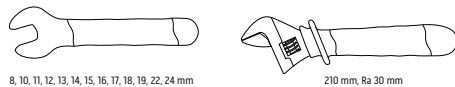

1000V  
CrV  
steel

52  
ELEMENTS

Ref.	0/1	EAN
01-311	0/1	5907558439991

KLUCZE NASADOWE / VDE SOCKET SET / НАБОР СМЕННЫХ ГОЛОВОК

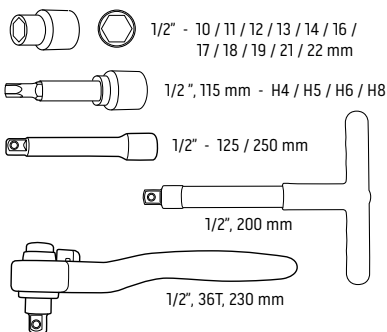

**19**  
ELEMENTS

Ref.		EAN
01-306	0/3	5907558435573

KLUCZE NASADOWE / VDE SOCKET SET / НАБОР СМЕННЫХ ГОЛОВОК

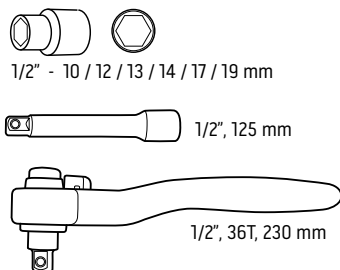

**8**  
ELEMENTS

Ref.		EAN
01-307	0/5	5907558435580

**NEO**  
TOOLS

**25**  
years  
GUARANTEE

TUV Rheland  
CERTIFIED

\*25 lat gwarancji oraz certyfikat TÜV M+T (Monitoring + Testing) posiadają wybrane produkty NEO – szczegóły na stronie neo-tools.com  
\*Selected NEO products feature a 25-year warranty and a TÜV M+T (Monitoring + Testing) certificate – you can find details at neo-tools.com  
\*Некоторые товары NEO имеют 25-летнюю гарантию и сертификаты TÜV M+T (Monitoring + Testing) – подробная информация доступна на сайте neo-tools.com



**GRZECHOTKA / RATCHET / КЛЮЧ ТРЕЩОТЧНЫЙ**

**NASADKA SZEŚCIOKĄTNA / HEXAGONAL SOCKET / ГОЛОВКА СМЕННАЯ 6-ГРАННАЯ**



Ref.	L [mm]	☐	EAN
01-180	230	4/28	5907558432817



Ref.	L [mm]	☐	EAN
01-181	10	12/108	5907558432893
01-182	11	12/108	5907558432909
01-183	12	12/108	5907558432916
01-184	13	12/108	5907558432923
01-185	14	12/108	5907558432930
01-186	16	12/108	5907558432947
01-187	17	12/108	5907558432954
01-188	18	12/108	5907558432961
01-189	19	12/108	5907558432978
01-190	21	11/110	5907558432985
01-191	22	11/110	5907558432992
01-192	24	11/110	5907558433005
01-193	27	15/105	5907558433012
01-194	30	10/90	5907558433029
01-195	32	10/90	5907558433036

**WKRETAK PŁASKI / SCREWDRIVER SLOTTED / ОТВЕРТКА ШЛИЦЕВАЯ**



Ref.	⊖	L[mm]	☐	EAN
04-051	2,5	75	12/600	5907558401998
04-052	3,0	100	12/240	5907558402001
04-053	4,0	100	12/240	5907558402018
04-054	5,5	125	12/144	5907558402025
04-055	6,5	150	12/144	5907558402032

**WKRETAK KRZYŻOWY / SCREWDRIVER POZIDRIV / ОТВЕРТКА КРЕСТОВАЯ**



Ref.	⊕	L[mm]	☐	EAN
04-062	PZ1	80	12/240	5907558402056
04-063	PZ2	100	12/144	5907558402063

**WKRETAK KRZYŻOWY / SCREWDRIVER PHILLIPS / ОТВЕРТКА КРЕСТОВАЯ**



Ref.	+	L[mm]	☐	EAN
04-071	PH0	60	12/240	5907558402056
04-072	PH1	80	12/144	5907558402063
04-073	PH2	100	12/144	5907558402094

**WKRETAK KRZYŻOWY / SCREWDRIVER / ОТВЕРТКА КРЕСТОВАЯ**



Ref.	+	L[mm]	☐	EAN
04-221	SL/PZ2	100	12/144	5907558432398
04-222	SL/PH2	100	12/144	5907558432404

## ZESTAW WKREŃAKÓW / SCREWDRIVER SET / НАБОР ОТВЕРТКОВ

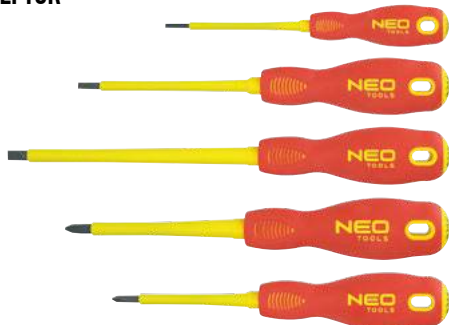

⊖ 2.5x75 mm, 4x100 mm, 6.5x150 mm

+	Ref.	☐	EAN
PH1x80 mm, PH2x100 mm	04-220	6/36	5907558402278

## ZESTAW WKREŃAKÓW / SCREWDRIVER SET / НАБОР ОТВЕРТКОВ



⊖ 3x100 mm, 4x100 mm, 5.5x100, 6.5x100, 8x175 mm

+	Ref.	☐	EAN
PH0x60 mm, PH1x80 mm, PH2x100, PH3x150 mm	04-142	0/12	5907558433340

## WKREŃAK KRZYŻOWY / SCREWDRIVER POZIDRIV / ОТВЕРТКА КРЕСТОВАЯ



Ref.	+	L[mm]	☐	EAN
04-136	P22	100	0/0	5907558433289

## ZESTAW WKREŃAKÓW / SCREWDRIVER SET / НАБОР ОТВЕРТКОВ



⊖ 3x100 mm, 4x100 mm, 5.5x125, 6.5x100, 8x175 mm

+	Ref.	☐	EAN
PH0x60 mm, PH1x80 mm, PH2x100, PH3x150 mm	04-143	0/12	5907558433357

## WKREŃAK KRZYŻOWY / SCREWDRIVER PHILLIPS / ОТВЕРТКА КРЕСТОВАЯ



Ref.	+	L[mm]	☐	EAN
04-137	PH0	60	12/120	5907558433296
04-138	PH1	80	12/120	5907558433302
04-139	PH2	100	12/120	5907558433319
04-140	PH2	175	12/120	5907558433326

## WKREŃAK PŁASKI / SCREWDRIVER SLOTTED / ОТВЕРТКА ШЛИЦЕВАЯ



Ref.	⊖	L[mm]	☐	EAN
04-130	0,4	75	12/120	5907558433227
04-131	0,6	100	12/120	5907558433234
04-132	0,8	100	12/120	5907558433241
04-133	1,0	125	12/120	5907558433258

**NEO**  
TOOLS

**25**  
years  
GUARANTEE

**TÜVRheinland**  
CERTIFIED

\* 25 lat gwarancji oraz certyfikat TÜV M+T (Monitoring + Testing) posiadają wybrane produkty NEO – szczegóły na stronie neo-tools.com  
\* Selected NEO products feature a 25-year warranty and a TÜV M+T (Monitoring + Testing) certificate – you can find details at neo-tools.com  
\* Некоторым товарам NEO имеет 25-летнюю гарантию и сертификат TÜV M+T (Monitoring + Testing) – подробная информация доступна на сайте neo-tools.com

**KOŃCÓWKI WKRĘTAKOWE Z UCHWYTEM / INSULATED CHANGEABLE SCREWDRIVER / ОТВЕРТОЧНЫЕ НАКОНЕЧНИКИ С ДЕРЖАТЕЛЕМ**

**S2**  
steel

**1000V**

**55-60 HRC**



**QUICK CHANGE**

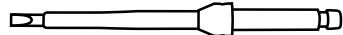

1000V, 100mm

SL: 2.0, 2.5, 3.0, 3.5, 4.0, 5.5, 6.5

PH: 0, 1, 2

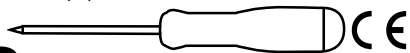

**12**  
ELEMENTS

Ref.	☐	EAN
01-308	0/20	5907558435597

**KOŃCÓWKI WKRĘTAKOWE Z UCHWYTEM / INSULATED CHANGEABLE SCREWDRIVER / ОТВЕРТОЧНЫЕ НАКОНЕЧНИКИ С ДЕРЖАТЕЛЕМ**

**S2**  
steel

**1000V**

**55-60 HRC**



**QUICK CHANGE**



1000V, 100mm

- ⊖ SL: 2.0 / 2.5 / 3.0 / 3.5 / 4.0 / 5.5 / 6.5
- ⊕ PH: PH0 / PH1 / PH2    ⊕ PZ: PZ0 / PZ1 / PZ2
- ⊛ T: T6 / T8 / T9 / T10 / T15 / T20 / T25 / T27 / T30
- ⊙ H: H2.5 / H3.0 / H4.0 / H5.0 / H6.0
- ⊠ R: R1 / R2
- ⊕ TRI: TRI 1 / TRI 2 / TRI 3 / TRI 4
- ⊕ TORO: TORO 4 / TORO 6 / TORO 8 / TORO 10
- ⊙ M: M4 / M5 / M6    ⊙ U: U4 / U6 / U8 / U10

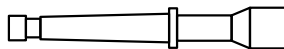

1000V, 89mm

- ⊙ 6.3 / 8.1    ⊕    ⊙

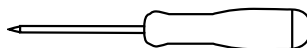

250 V **CE**

**50**  
ELEMENTS

Ref.	☐	EAN
01-309	0/10	5907558435603

**SZCZYPCY UNIWERSALNE / COMBINATION PLIERS / ПАССАТИЖИ КОМБИНИРОВАННЫЕ**



Ref.	L[mm]	□	EAN
01-240	160	6/48	5907558433364
01-241	180	6/48	5907558433371

**SZCZYPCY BOCZNE / DIAGONAL CUTTING PLIERS / БОКОРЕЗЫ**



Ref.	L[mm]	∅ [mm]	□	EAN
01-525	160	1.5; 2.5	6/48	5907558415650

**SZCZYPCY BOCZNE / SIDE CUTTING PLIER / КУСАЧКИ БОКОВЫЕ**



Ref.	L[mm]	□	EAN
01-243	160	6/48	5907558433395
01-244	180	6/48	5907558433401

**SZCZYPCY UNIWERSALNE / COMBINATION PLIERS / ПАССАТИЖИ КОМБИНИРОВАННЫЕ**



Ref.	L[mm]	□	EAN
01-220	160	6/60	5907558433043
01-221	180	6/60	5907558433050
01-222	200	0/0	5907558433067

**SZCZYPCY WYDŁUŻONE / LONG NOSE PLIERS / ПЛОСКОГУБЦЫ УДЛИНЕННЫЕ**

**SZCZYPCY WYDŁUŻONE PROSTE / LONG NOSE PLIERS / ПЛОСКОГУБЦЫ УДЛИНЕННЫЕ ПРЯМЫЕ**



Ref.	L[mm]	□	EAN
01-242	160	6/48	5907558433388



Ref.	pliers	L[mm]	□	EAN
01-223	long nose	160	6/60	5907558433074
01-224	long nose	180	6/60	5907558433081
01-225	long nose	200	6/60	5907558433098
01-227	bent nose	160	6/60	5907558433111
01-228	bent nose	180	6/60	5907558433128

**NEO TOOLS**

**25 years**  
GUARANTEE

**TÜVRheinland**  
CERTIFIED

\* 25 lat gwarancji oraz certyfikat TÜV M+T (Monitoring + Testing) posiadają wybrane produkty NEO – szczegóły na stronie neo-tools.com  
\* Selected NEO products feature a 25-year warranty and a TÜV M+T (Monitoring + Testing) certificate – you can find details at neo-tools.com  
\* Некоторые товары NEO имеют 25-летнюю гарантию и сертификат TÜV M+T (Monitoring + Testing) – подробная информация доступна на сайте neo-tools.com

**SZCZYPCE DO ZDEJMOWANIA IZOLACJI / WIRE STRIPPER PLIER / КУСАЧКИ ДЛЯ СЪЕМА ИЗОЛЯЦИИ**



25 years  
GUARANTEE

CrV  
steel

1000V

Ref.	L[mm]	☐	EAN
01-245	160	6/48	5907558433418

**SZCZYPCE DO ZDEJMOWANIA IZOLACJI / WIRE STRIPPER PLIER / КУСАЧКИ ДЛЯ СЪЕМА ИЗОЛЯЦИИ**



25 years  
GUARANTEE

CrV  
steel

1000V

Ref.	L[mm]	☐	EAN
01-229	160	6/60	5907558433135

**SZCZYPCE BOCZNE / SIDE CUTTING PLIER / КУСАЧКИ БОКОВЫЕ**



25 years  
GUARANTEE

CrV  
steel

1000V

Ref.	L[mm]	☐	EAN
01-226	160	6/60	5907558433104
01-231	180	6/60	5907558433159

**SZCZYPCE DO RUR / WATER PUMP PLIER / КЛЮЧ ТРУБНЫЙ РАЗВОДНОЙ**



25 years  
GUARANTEE

CrV  
steel

1000V

Ref.	L[mm]	☐	EAN
01-232	250	6/36	5907558433166

**SZCZYPCE WYDŁUŻONE PŁASKIE / FLAT NOSE PLIER / ПЛОСКОГУБЦЫ УДЛИНЕННЫЕ, ПРЯМЫЕ**



25 years  
GUARANTEE

CrV  
steel

1000V

Ref.	L[mm]	☐	EAN
01-230	160	0/0	5907558433142

**SZCZYPCE DO CIĘCIA KABLI / CABLE CUTTER / КАБЕЛЕРЕЗ**



25 years  
GUARANTEE

CrV  
steel

1000V

Ref.	L[mm]	☐	EAN
01-233	160	0/0	5907558433173

## ZESTAW SZCZYPIEC I WKREŃKAWÓW / VDE TOOL SET / НАБОР ИНСТРУМЕНТА С ОТВЕРТКАМИ



25  
years  
GUARANTEE

CrV  
steel

S2  
steel

1000V

- ⊖ 1.0 x 5.5 x 125 mm; 0.8 x 4 x 100 mm; 1.0 x 6.5 x 150 mm
- ⊕ PH0 x 3 x 60 mm; PH2 x 6 x 100 mm; PH1 x 4.5 x 80 mm; PH3 x 8 x 150 mm

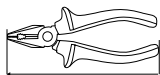

160mm

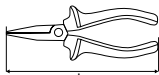

160mm

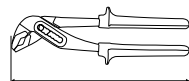

250mm



160mm

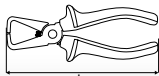

160mm



14  
ELEMENTS

Ref.	⊞	EAN
01-234	0/6	5907558433180

## ZESTAW SZCZYPIEC I WKREŃKAWÓW / VDE TOOL SET / НАБОР ИНСТРУМЕНТА С ОТВЕРТКАМИ



25  
years  
GUARANTEE

S2  
steel

CrV  
steel

1000V

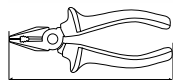

160mm

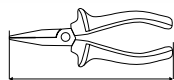

160mm

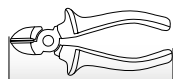

160mm

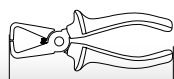

160mm

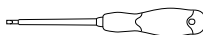

- ⊖ 1.0 x 5.5 x 125 mm
- ⊕ PH2 x 6 x 100 mm

7  
ELEMENTS

Ref.	⊞	EAN
01-235	0/0	5907558433197

**NEO**  
TOOLS

25  
years  
GUARANTEE

TÜVRheinland  
CERTIFIED

\* 25 lat gwarancji oraz certyfikat TÜV M+T (Monitoring + Testing) posiadają wybrane produkty NEO – szczegóły na stronie neo-tools.com  
\* Selected NEO products feature a 25-year warranty and a TÜV M+T (Monitoring + Testing) certificate – you can find details at neo-tools.com  
\* Некоторые товары NEO имеют 25-летнюю гарантию и сертификаты TÜV M+T (Monitoring + Testing) – подробная информация доступна на сайте neo-tools.com

ZESTAW SZCZYPIEC / VDE TOOL SET / НАБОР ШАРНИРНО-ГУБЦЕВОГО ИНСТРУМЕНТА



25 years  
GUARANTEE

CrV  
steel

1000V



4

ELEMENTS

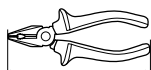

180mm

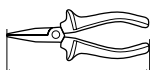

200mm



160mm

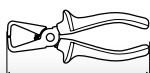

160mm

Ref.	☐	EAN
01-236	0/8	5907558433203

ZESTAW SZCZYPIEC I WKREŃKÓW / VDE TOOL SET / НАБОР ИНСТРУМЕНТА С ОТВЕРТКАМИ



25 years  
GUARANTEE

CrV  
steel

S2  
steel

1000V



7

ELEMENTS

⊖ 5.5x125 mm

⊕ PH1x80

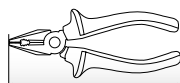

180mm



160mm

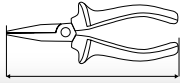

160mm

Ref.	☐	EAN
01-237	0/8	5907558433210

**SZCZYPCE DO ZACISKANIA KOŃCÓWEK / CRIMPING TOOL FOR TERMINALS, SET / ОБЖИМНЫЕ КЛЕЩИ ДЛЯ КОНЦОВ ВТУЛОК**



RG 6  
RG 58  
RG 59  
RG 62

Ref.	L[mm]	☐	EAN
01-537	220	0/5	5907558439304

**SZCZYPCE DO ZACISKANIA KOŃCÓWEK NIEIZOLOWANYCH / CRIMPING TOOL FOR NON-INSULATED TERMINALS / КЛЕЩИ ДЛЯ ОБЖИМА НЕИЗОЛИРОВАННЫХ НАКОНЕЧНИКОВ**



25 years GUARANTEE  
TÜV Rheinland CERTIFIED  
48-52 HRC

Ref.	L[mm]	Info	☐	EAN
01-502	250	22-12AWG	6/36	5907558408454

**SZCZYPCE DO KOŃCÓWEK TELEFONICZNYCH / MODULAR CRIMPING FOR CONNECTORS / КЛЕЩИ ДЛЯ ОБЖИМА ТЕЛЕФОННЫХ НАКОНЕЧНИКОВ**



25 years GUARANTEE  
TÜV Rheinland CERTIFIED  
SK5 steel  
42-48 HRC

Ref.	L[mm]	Info	☐	EAN
01-501	195	4P, 6P, 8P	8/48	5907558403206

**SZCZYPCE DO ZACISKANIA KOŃCÓWEK TULEJKOWYCH / PLIERS FOR CLAMPING TERMINALS / КЛЕЩИ ДЛЯ ОБЖИМА ТЕЛЕФОННЫХ НАКОНЕЧНИКОВ**



25 years GUARANTEE  
TÜV Rheinland CERTIFIED  
CrV steel  
CrMo steel  
45 HRC  
22-6 AWG 0.5-16mm²

Ref.	L[mm]	Info	☐	EAN
01-506	220	0.5-16 mm² (22-6 AWG)	12/24	5907558409994

**SZCZYPCE DO ZACISKANIA KOŃCÓWEK KONEKTOROWYCH / CRIMPING TOOL FOR INSULATED TERMINALS / КЛЕЩИ ДЛЯ ОБЖИМА КАБЕЛЬНЫХ НАКОНЕЧНИКОВ**



25 years GUARANTEE  
TÜV Rheinland CERTIFIED  
22-12 AWG  
52-57 HRC

Ref.	L[mm]	Info	☐	EAN
01-503	250	22-12AWG	6/36	5907558403213



**NEO TOOLS**

25 years GUARANTEE  
TÜV Rheinland CERTIFIED

\* 25 lat gwarancji oraz certyfikat TÜV M+T (Monitoring + Testing) posiadają wybrane produkty NEO – szczegóły na stronie neo-tools.com  
\* Selected NEO products feature a 25-year warranty and a TÜV M+T (Monitoring + Testing) certificate – you can find details at neo-tools.com  
\* Некоторые товары NEO имеют 25-летнюю гарантию и сертификат TÜV M+T (Monitoring + Testing) – подробная информация доступна на сайте neo-tools.com



**ZACISKARKA KOŃCÓWEK TULEJKOWYCH / WIRE FERRULE CLAMPING TOOL / КЛЕЩИ ДЛЯ ОБЖИМА ВТУЛОЧНЫХ НАКОНЕЧНИКОВ**



Ref.	L[mm]	Info	☐	EAN
01-507	170	0.25 - 6 mm <sup>2</sup>	5/20	5907558414394

**SZCZYPCE DO ZACISKANIA KOŃCÓWEK / CRIMPING PLIERS / КЛЕЩИ ДЛЯ ОБЖИМА НАКОНЕЧНИКОВ**



Ref.	Info	☐	EAN
01-532	0.25-2.5 mm <sup>2</sup>	20/80	5907558432367
01-533	1.5-6 mm <sup>2</sup>	20/80	5907558432374

**OBSCINAK DO KABLI MIEDZIANYCH I ALUMINIOWYCH / CABLE SCISSORS / КАБЕЛЕРЕЗ ДЛЯ МЕДНЫХ АЛЮМИНИЕВЫХ КАБЕЛЕЙ**



Ref.	L[mm]	☐	EAN
01-510	185	12/72	5907558405361

**ZACISKARKA KOŃCÓWEK TULEJKOWYCH / WIRE FERRULE CRIMPING TOOL / ОБЖИМНОЙ ИНСТРУМЕНТ ДЛЯ КОНЦОВ ВТУЛОК**



Ref.	L[mm]	Info	☐	EAN
01-536	210	6 - 16 mm <sup>2</sup>	5/20	5907558414394

**SZCZYPCE DO ZACISKANIA KOŃCÓWEK / CRIMPING PLIERS / КЛЕЩИ ДЛЯ ОБЖИМА НАКОНЕЧНИКОВ**



Ref.	L[mm]	Info	☐	EAN
01-530	390	6-50 mm <sup>2</sup> (10-1 AWG)	0/10	5907558432343
01-531	610	10-120 mm <sup>2</sup> (8-4/0 AWG)	0/5	5907558432350

**OBSCINAK DO KABLI MIEDZIANYCH I ALUMINIOWYCH / CABLE SCISSORS / КАБЕЛЕРЕЗ ДЛЯ МЕДНЫХ АЛЮМИНИЕВЫХ КАБЕЛЕЙ**



Ref.	L[mm]	max ø [mm]	☐	EAN
01-513	160	10	6/48	5907558408485
01-514	200	13	6/48	5907558408492
01-515	235	25	6/36	5907558408508

**OBSCINAK DO KABLI MIEDZIANYCH I ALUMINIOWYCH / CABLE CUTTER WITH RATCHET / КАБЕЛЕРЕЗ ДЛЯ МЕДНЫХ АЛЮМИНИЕВЫХ КАБЕЛЕЙ**



Ref.	L[mm]	max $\phi$ [mm <sup>2</sup> ]		EAN
01-516	250	325	10/30	5907558408522

**OBSCINAK DO KABLI MIEDZIANYCH I ALUMINIOWYCH / CABLE CUTTER WITH RATCHET / КАБЕЛЕРЕЗ ДЛЯ МЕДНЫХ АЛЮМИНИЕВЫХ КАБЕЛЕЙ**



Ref.	L[mm]	max $\phi$ [mm <sup>2</sup> ]		EAN
01-517	440	20	0/12	5907558408515

**OBSCINAK DO DRUTÓW I LINEK STALOWYCH / WIRE ROPE & SPRING WIRE CUTTER / НОЖНИЦЫ ДЛЯ РЕЗКИ АРМАТУРЫ И СТАЛЬНОГО ТРОСА**



Ref.	L[mm]		EAN
01-512	190	10/60	5907558410891

**OBSCINAK DO KABLI MIEDZIANYCH I ALUMINIOWYCH / CABLE CUTTER WITH RATCHET / КАБЕЛЕРЕЗ ДЛЯ МЕДНЫХ АЛЮМИНИЕВЫХ КАБЕЛЕЙ**



Ref.	L[mm]	max $\phi$ [mm <sup>2</sup> ]		EAN
01-401	400	400		5907558449624

**OBSCINAK DO DRUTÓW / WIRE CUTTER / НОЖНИЦЫ ДЛЯ ТРОСА**



Ref.	L[mm]		EAN
01-518	210	6/48	5907558413007

**NOŻYCE DO KABLI I IZOLACJI / ELECTRICIAN SCISSORS / НОЖНИЦЫ ДЛЯ КАБЕЛЯ И ИЗОЛИРУЮЩЕЙ ОБОЛОЧКИ**



Ref.	L[mm]		EAN
01-511	140	12/72	5907558405378

**NEO TOOLS**



\* 25 lat gwarancji oraz certyfikat TÜV M+T (Monitoring + Testing) posiadają wybrane produkty NEO – szczegóły na stronie neo-tools.com  
\* Selected NEO products feature a 25-year warranty and a TÜV M+T (Monitoring + Testing) certificate – you can find details at neo-tools.com  
\* Некоторые товары NEO имеют 25-летнюю гарантию и сертификат TÜV M+T (Monitoring + Testing) – подробная информация доступна на сайте neo-tools.com

**AUTOMATYCZNY ŚCIAĞACZ IZOLACJI / AUTOMATIC WIRE STRIPPER / СЪЕМНИК ИЗОЛЯЦИИ АВТОМАТИЧЕСКИЙ**



Ref.	L[mm]		EAN
01-500	205	10/60	5907558403190

**AUTOMATYCZNY ŚCIAĞACZ IZOLACJI / AUTOMATIC WIRE STRIPPER / СЪЕМНИК ИЗОЛЯЦИИ АВТОМАТИЧЕСКИЙ**

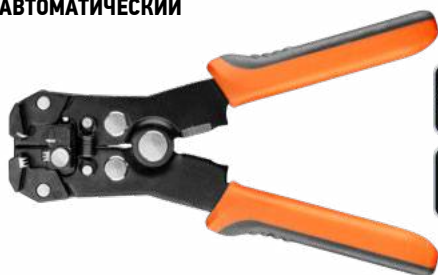

Ref.	L[mm]		EAN
01-534	160 mm	10/40	5907558439359

**AUTOMATYCZNY ŚCIAĞACZ IZOLACJI / AUTOMATIC WIRE STRIPPER / СЪЕМНИК ИЗОЛЯЦИИ АВТОМАТИЧЕСКИЙ**



Ref.	L[mm]		EAN
01-519	195	10/ 60	5907558415599

**AUTOMATYCZNY ŚCIAĞACZ IZOLACJI / AUTOMATIC WIRE STRIPPER / СЪЕМНИК ИЗОЛЯЦИИ АВТОМАТИЧЕСКИЙ**



Ref.	L[mm]		EAN
01-540	200		5907558454994

**AUTOMATYCZNY ŚCIAĞACZ IZOLACJI / AUTOMATIC WIRE STRIPPER / СЪЕМНИК ИЗОЛЯЦИИ АВТОМАТИЧЕСКИЙ**



Ref.	L[mm]		EAN
01-538	175 mm	8/48	5907558484571

**AUTOMATYCZNY ŚCIAĞACZ IZOLACJI / AUTOMATIC WIRE STRIPPER / СЪЕМНИК ИЗОЛЯЦИИ АВТОМАТИЧЕСКИЙ**



Ref.	L[mm]		EAN
01-520	170	8/48	5907558415605

## ŚCIĄGACZ DO IZOLACJI / WIRE STRIPPER / СЪЕМНИК ИЗОЛЯЦИИ



Ref.	L[mm]	☐	EAN
01-524	125	15/90	5907558415643

## ŚCIĄGACZ DO IZOLACJI / WIRE STRIPPER / СЪЕМНИК ИЗОЛЯЦИИ



Ref.	L[mm]	☐	EAN
01-400	170	0/40	5907558449617

## NOŻ MONTERSKI / VDE CABLE KNIFE / НОЖ МОНТЕРСКИЙ



Ref.	L[mm]	L <sub>1</sub> [mm]	☐	EAN
01-550	195	50	12/72	5907558409239

## NOŻ MONTERSKI / VDE CABLE KNIFE / НОЖ МОНТЕРСКИЙ



Ref.	L[mm]	L <sub>1</sub> [mm]	☐	EAN
01-551	190	50	12/72	5907558409246

## KLUCZ PŁASKI / FLAT SPANNER / КЛЮЧ С ОТКРЫТЫМ ЗЕВОМ, ОДНОСТОРОННИЙ



Ref.	D[mm]	☐	EAN
01-110	6	9/108	5907558432411
01-111	7	9/108	5907558432428
01-112	8	9/108	5907558432435
01-113	9	9/108	5907558432442
01-114	10	9/108	5907558432459
01-115	11	9/108	5907558432466
01-116	12	9/108	5907558432473
01-117	13	9/108	5907558432480
01-118	14	8/72	5907558432497
01-119	15	8/72	5907558432503
01-120	16	8/72	5907558432510
01-121	17	8/72	5907558432527
01-122	18	8/72	5907558432534
01-123	19	8/72	5907558432541
01-124	21	6/54	5907558432558
01-125	22	6/54	5907558432565
01-126	24	6/54	5907558432572
01-127	27	6/36	5907558432589
01-128	30	6/36	5907558432596
01-129	32	6/36	5907558432602

## KLUCZ SZEŚCIOKĄTNY / HEX KEY / КЛЮЧ ШЕСТИГРАННЫЙ



Ref.	⊙	☐	EAN
01-171	3	8/72	5907558432824
01-172	4	8/72	5907558432831
01-173	5	6/72	5907558432848
01-174	6	6/54	5907558432855
01-175	8	8/48	5907558432862
01-176	10	8/48	5907558432879
01-177	12	6/36	5907558432886

**NEO**  
TOOLS

**25**  
years  
GUARANTEE

**TÜV Rheinland**  
CERTIFIED

\* 25 lat gwarancji oraz certyfikat TÜV M+T (Monitoring + Testing) posiadają wybrane produkty NEO – szczegóły na stronie neo-tools.com  
\* Selected NEO products feature a 25-year warranty and a TÜV M+T (Monitoring + Testing) certificate – you can find details at neo-tools.com  
\* Некоторые товары NEO имеют 25-летнюю гарантию и сертификат TÜV M+T (Monitoring + Testing) – подробная информация доступна на сайте neo-tools.com

**MIERNIK ELEKTRONICZNY UNIWERSALNY /  
UNIVERSAL MULTIMETER / МУЛЬТИМЕТР  
ЦИФРОВОЙ**



V DC 0-300	V AC 0-300	A DC 0-10	A AC 0-10	$\Omega$ 0-20M	$\frac{1}{f}$ 20n-1000 $\mu$
T °C -20-1000	$\frac{1}{\beta}$ hFE	LCD 1999	Auto Range	Data hold function	$\rightarrow$ Speaker
CAT III 300V	Nylon bag	x3 AAA	Ref. 94-001	0/26	EAN 5907558409154

**MIERNIK SĘGOWY / DIGITAL CLAMP METER / КЛЕЩИ  
ЭЛЕКТРОИЗМЕРИТЕЛЬНЫЕ**

**MIERNIK SĘGOWY / DIGITAL CLAMP METER / КЛЕЩИ  
ЭЛЕКТРОИЗМЕРИТЕЛЬНЫЕ**



V DC 0-600	V AC 0-600	A AC 0-300	$\Omega$ 0-20M	T °C -20-1000	Data hold function
$\rightarrow$ Speaker	Auto Range	LCD 1999	CAT II 600V	x3 AAA	
Ref. 94-002	0/20	EAN 5907558409161			



V DC 0-600	V AC 0-600	A DC 0-600	A AC 0-600	$\Omega$ 0-40M	Auto Range
LCD 3999	Synthetic leather bag	Data hold function	CAT II 600V	x2 AAA	
Ref. 94-003	0/26	EAN 5907558407662			

**MIERNIK CYFROWY / DIGITAL MULTIMETER /  
ЦИФРОВОЙ СЧЕТЧИК**

AC 600V	DC 600V	$\Omega$ 0.1-60M	Live NCV	10Hz -8MHz	NCV measurement
Data hold function	$\rightarrow$ Speaker	room temperature	LCD 5999	multicolor display	FLASHLIGHT
Cat II 600V	nylon bag	2x AAA not included	true RMS	AUTO recognition	139x 68x 18mm
175g	Ref. 94-004	0/80	EAN 5907558469523		

**WYKRYWACZ Z WYŚWIETLACZEM, 3 W 1 / WALL  
SCANNER 3 IN 1 / ДЕТЕКТОР С ДИСПЛЕЕМ, 3 В 1**



Ref.	☐	EAN
75-250	0/40	5907558455243

**DALMIERZ LASEROWY / LASER DISTANCER /  
ЛАЗЕРНЫЙ ДАЛЬНОМЕР**



Ref.	☐	EAN
75-204	0/50	5907558463316

**LASER KRZYŻOWY / SELF-LEVELING CROSS LINE  
LASER LEVEL / ЛАЗЕР ПЕРЕКРЕСТНЫЙ**

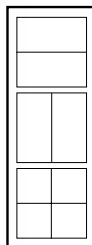

Ref.	☐	EAN
75-100	0/12	5907558433999

**LASER KRZYŻOWY / SELF-LEVELING CROSS LINE  
LASER LEVEL / ЛАЗЕР ПЕРЕКРЕСТНЫЙ**

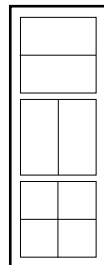

Ref.	☐	EAN
75-101	0/12	5907558434002

**NEO  
TOOLS**

**25  
years  
GUARANTEE**

**TÜVRheinland  
CERTIFIED**

\* 25 lat gwarancji oraz certyfikat TÜV M+T (Monitoring + Testing) posiadają wybrane produkty NEO – szczegóły na stronie neo-tools.com  
\* Selected NEO products feature a 25-year warranty and a TÜV M+T (Monitoring + Testing) certificate – you can find details at neo-tools.com  
\* Некоторые товары NEO имеют 25-летнюю гарантию и сертификаты TÜV M+T (Monitoring + Testing) – подробная информация доступна на сайте neo-tools.com

**TAŚMA IZOLACYJNA / INSULATING TAPE /  
ИЗОЛЯЦИОННАЯ ЛЕНТА**

15 mm x 0.13 mm x 10m



Ref.			EAN
01-526		10/500	5907558439311
01-528		10/500	5907558439335

**KLUCZYK UNIWERSALNY DO SZAFEK /  
MULTIFUNCTION KEY / КЛЮЧ К ШКАФУ**



Ref.		EAN
02-001	50/200	5907558404319

**ZESTAW NARZĘDZI DO FOTOWOLTAIKI /  
PHOTOVOLTAIC SERVICE TOOL KIT / НАБОР  
ИНСТРУМЕНТОВ ДЛЯ ФОТОВОЛЬТАИКИ**



Ref.		EAN
01-559	0/5	5907558460209

**KONEKTORY ZESTAW / ELECTRIC CONNECTORS SET /  
КОННЕКТОРЫ НАБОР**

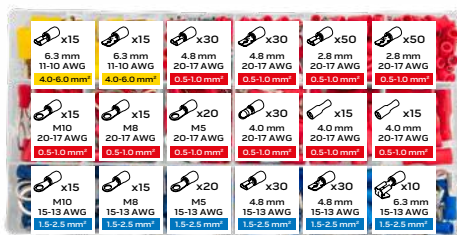

Ref.		EAN
01-535	0/36	5907558439366

**KLUCZYK UNIWERSALNY DO SZAFEK /  
MULTIFUNCTION KEY / КЛЮЧ К ШКАФУ**

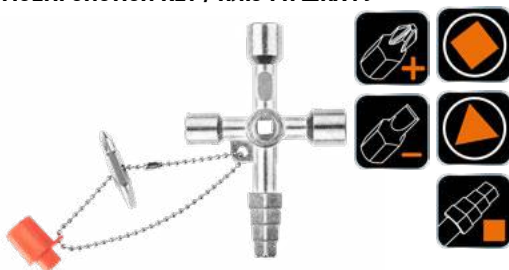

Ref.	[mm]		EAN
01-402	6.2, 7.2, 8.2	24/192	5907558449631

**SZCZYPCE DO ZACISKANIA KONEKTORÓW  
FOTOWOLTAICZNYCH / CRIMPING PLIERS FOR  
CONNECTORS / КЛЕЩИ ДЛЯ ОПРЕССОВКИ  
РАЗЪЕМОВ**



Ref.		EAN
01-556	10/40	5907558460230

**SZCZYPCE DO ZACISKANIA KONEKTORÓW FOTOWOLTAICZNYCH / CRIMPING PLIERS FOR CONNECTORS / КЛЕЩИ ДЛЯ ОПРЕССОВКИ РАЗЪЕМОВ**



Ref.	☐	EAN
01-555	10/20	5902062063427

**ŚCIĄGACZ IZOLACJI FOTOWOLTAIKA / PHOTOVOLTAIC WIRE STRIPPER / ИНСТРУМЕНТ ДЛЯ СНЯТИЯ ИЗОЛЯЦИИ ФОТОВОЛЬТАИКА**



Ref.	☐	EAN
01-557	10/20	5907558460216

**KLUCZE DO ZŁĄCZ FOTOWOLTAICZNYCH / PHOTOVOLTAIC CONNECTOR WRENCHES / КЛЮЧИ ДЛЯ ФОТОВОЛЬТАИКИ**

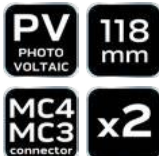

Ref.	☐	EAN
01-558	15/60	5907558460223



**NEO**  
TOOLS

**25**  
years  
GUARANTEE

**TÜV**Rheinland  
CERTIFIED

\* 25 lat gwarancji oraz certyfikat TÜV M+T (Monitoring + Testing) posiadają wybrane produkty NEO – szczegóły na stronie neo-tools.com  
\* Selected NEO products feature a 25-year warranty and a TÜV M+T (Monitoring + Testing) certificate – you can find details at neo-tools.com  
\* Некоторые товары NEO имеют 25-летнюю гарантию и сертификаты TÜV M+T (Monitoring + Testing) – подробная информация доступна на сайте neo-tools.com



**WKRĘTAK AKUMULATOROWY MICRO-USB / CORDLESS SCREWDRIVER MICRO-USB / АККУМУЛЯТОРНАЯ ОТВЕРТКА MICRO-USB**



Ref.		EAN
04-200	0/16	5907558439380

**KOŃCÓWKI WKRĘTAKOWE Z UCHWYTEM / SCREWDRIVER BITS WITH HOLDER / ОТВЕРТОЧНЫЕ НАКОНЕЧНИКИ С ДЕРЖАТЕЛЕМ**

**KOŃCÓWKI WKRĘTAKOWE Z UCHWYTEM / SCREWDRIVER BITS WITH HOLDER / ОТВЕРТОЧНЫЕ НАКОНЕЧНИКИ С ДЕРЖАТЕЛЕМ**



x73



6.3 x 25 mm

4 x 28 mm

3; 4; 5; 6; 7 1

: 1.5; 2; 2.5; 3; 3.5; 4

4; 5; 6; 6.5

1; 1.5; 2; 2.5; 3.5

T9; T10; T15; T20; T25; T30

T3; T4; T5; T6; T7; T8; T9; T10; T15; T20

H2.5; H3; H4; H5; H6

H0.9; H1.3; H1.5; H2; H2.5; H3; H3.5; H4; H4.5; H5; H6

PZ1; PZ2; PZ3

Y2

Y1; Y2; Y3

U2.6

U6; U8

0.8

2.32

: 2.3

R1



6.3 x 25 mm

4 x 28 mm

3; 4; 5; 6; 7 1

: 5; 2; 2.5; 3; 3.5

4; 5; 6; 6.5

2; 2.5; 3; 3.5

T4; T5; T6; T7; T8; T9; T10; T15; T20; T25; T30

T3; T4; T5; T6; T7; T8; T9; T10; T15; T20

H2.5; H3; H4; H5; H6

H2.5; H3; H4

PZ1; PZ2; PZ3

3

Y1

5; 6; 7; 8; 9; 10; 11; 12; 13 mm

U6

2.3

R1

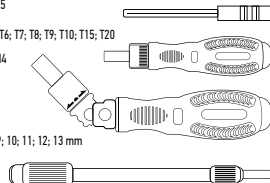

Ref.		EAN
06-115	0/10	5907558431896

Ref.		EAN
06-116	0/10	5907558431902

**KOŃCÓWKI WKRĘTAKOWE PRECYZYJNE Z UCHWYTEM / PRECISION SCREWDRIVER BITS WITH HOLDER / ПРЕЦИЗИОННЫЕ СМЕННЫЕ НАКОНЕЧНИКИ С ДЕРЖАТЕЛЕМ**



CrV  
steel

PRECISION  
set

x53



4; 4.5; 5; 5.5; 6; 7 mm

2.5; 3; 3.5; 4; 4.5; 5; 5.5 mm

1; 1.5; 2; 2.5; 3; 3.5; 4 mm

1; 1.5; 2; 2.5; 3.5

T3; T4; T5; T6; T7; T8; T9; T10; T15; T20

H0.9; H1.3; H1.5; H2; H2.5; H3; H3.5; H4

Y0.8; Y2

2

U2.6

SIMIN 0.8

0.8

1.5

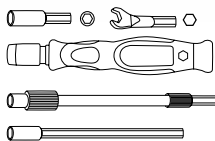

Ref.	Box	EAN
06-111	20/40	5907558431889

**ZESTAW DO SERWISOWANIA SMARTFONÓW / SMART PHONE REPAIR KIT / НАБОР ДЛЯ РЕМОНТА СМАРТФОНОВ**

25  
years  
GUARANTEE



PH000; PH00

1.2

T4; T5; T6; T8; T10

0.8

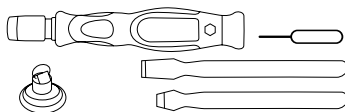

Ref.	Box	EAN
06-108	6/36	5907558404340

**UNIERSALNY UCHWYT DO SMARTFONÓW / UNIVERSAL PHONE HOLDER / УНИВЕРСАЛЬНЫЙ ДЕРЖАТЕЛЬ ДЛЯ СМАРТФОНОВ**



Ref.	Box	EAN
06-123	0/40	5907558444759

**NEO  
TOOLS**

25  
years  
GUARANTEE

TÜVRheinland  
CERTIFIED

\*25 lat gwarancji oraz certyfikat TÜV M+T (Monitoring + Testing) posiadają wybrane produkty NEO – szczegóły na stronie neo-tools.com  
\*Selected NEO products feature a 25-year warranty and a TÜV M+T (Monitoring + Testing) certificate – you can find details at neo-tools.com  
\*Некоторые товары NEO имеют 25-летнюю гарантию и сертификаты TÜV M+T (Monitoring + Testing) – подробная информация доступна на сайте neo-tools.com

**OPASKA MAGNETYCZNA / MAGNETIC BAND /  
МАГНИТНЫЙ ФИКСАТОР**



Ref.		EAN
06-121	0/80	5907558444735

**MATA ANTYSTATYCZNA / ANTI-STATIC MAT /  
АНТИСТАТИЧЕСКИЙ КОВРИК**



Ref.	info		EAN
06-124	359 x 260 x 5 mm	0/40	5907558444766

**SZKŁO POWIĘKSZAJĄCE / MAGNIFYING GLASS / ЛУПА**



Ref.	Info		EAN
06-129	110mm DPT 2.5x, 20mm DPT 4x, 20mm DPT 25x	10/80	5907558444810

**SZCZYPCE DO EKRAŃÓW / SCREEN OPENING TOOL /  
ЩИПЦЫ ДЛЯ ЭКРАНА**



Ref.		EAN
06-122	0/80	5907558444742

**SZPATUŁKI / SPUDGERS / ЛОПАТКИ**

**x3**



Ref.		EAN
06-118	0/10	5907558431902

**SOCZEWKI POWIĘKSZAJĄCE / MAGNIFYING LENSES /  
УВЕЛИЧИТЕЛЬНЫЕ ЛИНЗЫ**



Ref.	DPT		EAN
06-130	1.0x, 1.5x, 2.0x, 2.5x, 3.5x	0/40	5907558444827

ZESTAW OTWIERAKÓW / OPENER SET / КОМПЛЕКТ ИНСТРУМЕНТОВ ДЛЯ ДЕМОНТАЖА БЫТОВОЙ ЭЛЕКТРОНИКИ



x10

ANTI  
STATC



Ref.	☐	EAN
06-125	0/100	5907558444773

ZESTAW OTWIERAKÓW / OPENER SET / КОМПЛЕКТ ИНСТРУМЕНТОВ ДЛЯ ДЕМОНТАЖА БЫТОВОЙ ЭЛЕКТРОНИКИ

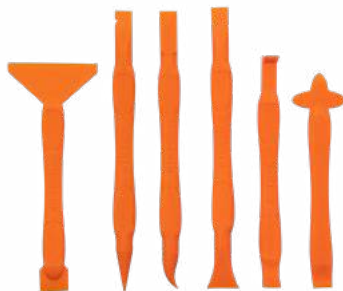

x6

ANTI  
STATC

Ref.	☐	EAN
06-126	0/120	5907558444780

ZESTAW OTWIERAKÓW / OPENER SET / КОМПЛЕКТ ИНСТРУМЕНТОВ ДЛЯ ДЕМОНТАЖА БЫТОВОЙ ЭЛЕКТРОНИКИ



x13

ANTI  
STATC

Ref.	☐	EAN
06-127	0/120	5907558444797

CHWYTAK AKCESORIÓW ELEKTRONICZNYCH / ELECTRONIC ACCESSORIES GRIPPER / ЗАХВАТЫ ДЛЯ ЭЛЕКТРОННЫХ ПРИНАДЛЕЖНОСТЕЙ

STEEL



Ref.	Info	☐	EAN
06-119	110 mm	0/200	5907558444711

**NEO**  
TOOLS

**25**  
years  
GUARANTEE

**TÜVRheinland**  
CERTIFIED

\* 25 lat gwarancji oraz certyfikat TÜV M+T (Monitoring + Testing) posiadają wybrane produkty NEO – szczegóły na stronie neo-tools.com

\* Selected NEO products feature a 25-year warranty and a TÜV M+T (Monitoring + Testing) certificate – you can find details at neo-tools.com

\* Некоторые товары NEO имеют 25-летнюю гарантию и сертификат TÜV M+T (Monitoring + Testing) – подробная информация доступна на сайте neo-tools.com

**SZCZYPCE PRECYZYJNE CZOŁOWE / END CUTTING  
PLIERS / КУСАЧКИ ТОРЦЕВЫЕ ПРЕЦИЗИОННЫЕ**



Ref.	L[mm]	☐	EAN
01-101	115	6/96	5907558401677

**SZCZYPCE PRECYZYJNE WYDŁUŻONE PROSTE /  
LONG NOSE PLIERS / ПЛОСКОГУБЦЫ УДЛИНЕННЫЕ  
ПРЯМЫЕ ПРЕЦИЗИОННЫЕ**



Ref.	L[mm]	☐	EAN
01-102	130	6/96	5907558401684

**SZCZYPCE PRECYZYJNE WYDŁUŻONE WYGIĘTE / BENT  
NEEDLE PLIERS / ПЛОСКОГУБЦЫ УДЛИНЕННЫЕ  
ИЗОГНУТЫЕ ПРЕЦИЗИОННЫЕ**



Ref.	L[mm]	☐	EAN
01-103	140	6/96	5907558401691

**SZCZYPCE PRECYZYJNE PŁASKIE / FLAT NOSE PLIERS  
/ ПЛОСКОГУБЦЫ ПРЕЦИЗИОННЫЕ**



Ref.	L[mm]	☐	EAN
01-105	130	6/96	5907558401714

**SZCZYPCE PRECYZYJNE BOCZNE / DIAGONAL CUTTING  
PLIERS / КУСАЧКИ БОКОВЫЕ ПРЕЦИЗИОННЫЕ**



Ref.	L[mm]	☐	EAN
01-106	110	6/96	5907558401721

**SZCZYPCE PRECYZYJNE BOCZNE / PRECISE SIDE  
CUTTERS / КУСАЧКИ БОКОВЫЕ ПРЕЦИЗИОННЫЕ**



Ref.	L[mm]	Ø [mm]	☐	EAN
01-509	140	0,8 - 2,6	10/50	5907558439281

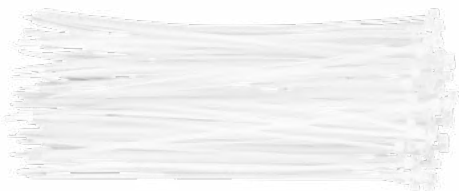

Ref.	Info	☐	EAN
01-600	2.5 x 100 mm, 100 szt.	0/250	5907558468007
01-602	2.5 x 200 mm, 100 szt.,	0/250	5907558468021
01-603	3.6 x 300 mm, 100 szt.	0/125	5907558468038
01-606	3,6 x 200 mm, 100 szt.	0/200	5907558468069
01-608	4.8 x 200 mm, 75 szt.	0/200	5907558468083
01-610	4.8 x 300 mm, 75 szt.	0/150	5907558468106
01-612	4.8 x 370 mm, 75 szt.	0/100	5907558468120
01-613	7.6 x 500 mm, 75 szt.	0/50	5907558468137

Ref.	Info	☐	EAN
01-601	2.5 x 200 mm, 100 szt.	0/250	5907558468014
01-604	3.6 x 300 mm, 100 szt.	0/125	5907558468045
01-605	2.5 x 100 mm, 100 szt.	0/250	5907558468052
01-607	4,8 x 200 mm, 75 szt.	0/200	5907558468076
01-609	4.8 x 300 mm, 75 szt.	0/150	5907558468090
01-611	4.8 x 370 mm, 75 szt.	0/100	5907558468113
01-614	7.6 x 500 mm, 75 szt.	0/50	5907558468144

LATARKA CZŁOWA AKUMULATOROWA / HEADLAMP RECHARGEABLE / НАЛОБНЫЙ ФОНАРЬ С АККУМУЛЯТОРОМ

long press:



MOTION SENSOR

3W 180lm	COB LED	MOTION DETECTOR	BATTERY Liton 3.7V 500mAh
50g	ABS BODY	USB	
2.5h working	IPX4	360°	
RED STROBE	RED LIGHT MODE	CAP HOOK	1.5h charging

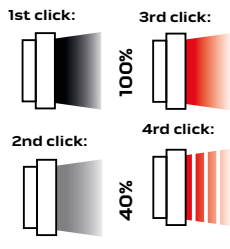

Ref.	☐	EAN
99-069	6/48	5907558464931

LATARKA AKUMULATOROWA / FLASHLIGHT RECHARGEABLE / ПЕРЕЗАРЯЖАЕМЫЙ USB-ФОНАРИК

ROTATING	MAGNETIC	USB charging
----------	----------	--------------



3W 300 max lm	BATTERY Liton 3.7V 2000mAh	CREE XPE+COB LED	ALUMINIUM BODY
3h charging	POCKET CLIP	small size EDC compatible	

Ref.	☐	EAN
99-034	50/100	5907558451443

**NEO TOOLS**

**25 years**  
GUARANTEE

TÜVRheinland  
CERTIFIED

\* 25 lat gwarancji oraz certyfikat TÜV M+T (Monitoring + Testing) posiadają wybrane produkty NEO – szczegóły na stronie neo-tools.com  
\* Selected NEO products feature a 25-year warranty and a TÜV M+T (Monitoring + Testing) certificate – you can find details at neo-tools.com  
\* Некоторые товары NEO имеют 25-летнюю гарантию и сертификаты TÜV M+T (Monitoring + Testing) – подробная информация доступна на сайте neo-tools.com

LAMPA WARSZTATOWA / WORKSHOP LAMP / ЛАМПА ПЕРЕНОСНАЯ

1st click:  
100%  
max 1.5 h

2nd click:  
50%  
max 3 h

3rd click:  
100%  
max 3 h

4th click: OFF

press 2 seconds:  
RED LIGHT  
max 3 h

+ click 1:  
RED STROBE

+ click 2: OFF



3W  
200 max lm

COB LED  
2in1  
LAMP + TORCH

FOLDING  
BATTERY  
Li-Ion  
3.7 V  
1200mAh

4h  
charging

USB  
charger  
+ cable

IP20



Ref.	☐	EAN
99-041	0/50	5907558452327

LAMPA WARSZTATOWA / WORKSHOP LAMP / ЛАМПА ПЕРЕНОСНАЯ



30W  
3000 max lm

CHARGER  
INCLUDED

SMD LED

BATTERY  
Li-Ion  
3.7 V  
8000mAh

ABS  
+ AL

CAPACITY  
INDICATION

POWER  
BANK

USB C  
charger  
+ cable

4.5h  
charging

ADJUSTABLE  
SUPPORT

TRANSPORT  
HANDLE

IP54

210x  
180x  
55 mm

Ref.	☐	EAN
99-064	0/10	5907558464887

REFLEKTOR / FLOODLIGHT / ПРОЖЕКТОР



SMD LED

H 1.8 m  
MAX

50W  
4500 lm

BEAM  
ANGLE  
>120°

230V  
50Hz

25000h  
work time

6500  
K

60%  
<1.0s

-25° <  
>45°

CRI  
Ra ≥ 80

PF > 0.9

ON/OFF  
≥ 15000

IP65

NO  
DIMM

CABLE  
3m  
EU plug

Ref.	☐	EAN
99-060	0/4	5907558452570

REFLEKTOR / FLOODLIGHT / ПРОЖЕКТОР



SMD LED

H 1.8 m  
MAX

2x50W  
9000 lm

230V  
50Hz

BEAM  
ANGLE  
>120°

25000h  
work time

6500  
K

60%  
<1.0s

-25° <  
>45°

CRI  
Ra ≥ 80

PF > 0.9

ON/OFF  
≥ 15000

IP65

NO  
DIMM

CABLE  
3m  
EU plug

Ref.	☐	EAN
99-062	0/4	5907558452594

**NÓŻ Z OSTRZEM ŁAMANYM / SNAP-OFF BLADE KNIFE / НОЖ С ОТЛАМЫВАЮЩИМСЯ ЛЕЗВИЕМ**



Ref.	W [mm]	☐	EAN
63-011	18	12/72	5907558410440

**OSTRZA ŁAMANE WYMIENNE / SNAP-OFF BLADES / ЛЕЗВИЯ СМЕННЫЕ ОТЛАМЫВАЮЩИЕСЯ**



Ref.	L[mm]	☐	EAN
64-010	18	10/300	5907558400229

**NÓŻ Z OSTRZEM ŁAMANYM / SNAP-OFF BLADE KNIFE / НОЖ С ОТЛАМЫВАЮЩИМСЯ ЛЕЗВИЕМ**



Ref.	W [mm]	☐	EAN
63-012	25	12/72	5907558443530

**OSTRZA ŁAMANE WYMIENNE / SNAP-OFF BLADES / ЛЕЗВИЯ СМЕННЫЕ ОТЛАМЫВАЮЩИЕСЯ**



Ref.	L[mm]	☐	EAN
64-014	25	10/120	5907558443561

**NÓŻ Z OSTRZEM TRAPEZOWYM / RETRACTABLE BLADE KNIFE / НОЖ С ТРАПЕЦИЕВИДНЫМ ЛЕЗВИЕМ**



**OSTRZA TRAPEZOWE / KNIFE BLADES / ЛЕЗВИЯ СМЕННЫЕ ТРАПЕЦИЕВИДНЫЕ**



Ref.	L[mm]	☐	EAN
63-701	18	12/72	5907558400083

Ref.	Info	L[mm]	☐	EAN
64-410	x5	52	10/300	5907558400267

**NEO TOOLS**

**25 years**  
GUARANTEE



\*25 lat gwarancji oraz certyfikat TÜV M+T (Monitoring + Testing) posiadają wybrane produkty NEO – szczegóły na stronie neo-tools.com  
\*Selected NEO products feature a 25-year warranty and a TÜV M+T (Monitoring + Testing) certificate – you can find details at neo-tools.com  
\*Некоторые товары NEO имеют 25-летнюю гарантию и сертификат TÜV M+T (Monitoring + Testing) – подробная информация доступна на сайте neo-tools.com



**NÓŻ SKŁADANY Z BLOKADĄ / FOLDING KNIFE WITH LOCK / НОЖ СКЛАДНОЙ С ФИКСАТОРОМ**



Ref.	☐	EAN
63-025	6/48	5907558420968

**NÓŻ SKŁADANY Z BLOKADĄ / FOLDING KNIFE WITH LOCK / НОЖ СКЛАДНОЙ С ФИКСАТОРОМ**



Ref.	☐	EAN
63-026	6/48	5907558420975

**NARZĘDZIE WIELOFUNKCYJNE / MULTI FUNCTION TOOL / МНОГОФУНКЦИОНАЛЬНЫЙ ИНСТРУМЕНТ**

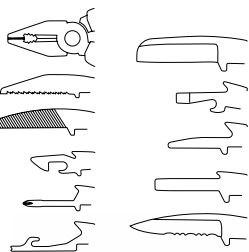

Ref.	W [mm]	☐	EAN
01-026	155	6/36	5907558420937

**NARZĘDZIE WIELOFUNKCYJNE / MULTI FUNCTION TOOL / МНОГОФУНКЦИОНАЛЬНЫЙ ИНСТРУМЕНТ**

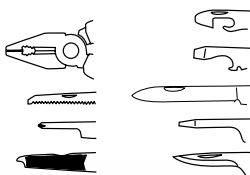

Ref.	W [mm]	☐	EAN
01-027	105	6/48	5907558420944

**NARZĘDZIE WIELOFUNKCYJNE / MULTI FUNCTION  
TOOL / МНОГОФУНКЦИОНАЛЬНЫЙ ИНСТРУМЕНТ**

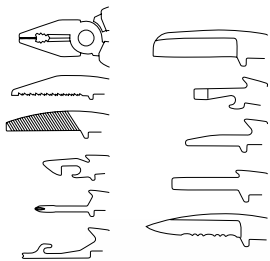

ALUMINIUM  
BODY

11  
in 1

STOP

+

Ref.	W [mm]	☐	EAN
01-028	150	6/36	5907558420951

**NABÓJ Z GAZEM BUTAN / BUTANE GAS CARTRIDGE /  
БАЛЛОН С ГАЗОМ БУТАН**



227  
g

Ref.	☐	EAN
20-030	4/28	5907558449655

**MIKROPALNIK GAZOWY / GAS MICROBURNER /  
ГАЗОВАЯ МИКРОГОРЕЛКА**



Ref.	☐	EAN
19-904	0/40	5907558465716

**MIKROPALNIK GAZOWY / GAS MICROBURNER /  
ГАЗОВАЯ МИКРОГОРЕЛКА**



Ref.	☐	EAN
19-905	0/40	5907558465723

**PALNIK GAZOWY / GAS BURNER / ГОРЕЛКА ГАЗОВАЯ**



Ref.	☐	EAN
20-025	10/100	5907558449648

**NEO  
TOOLS**

**25**  
years  
GUARANTEE

**TÜVRheinland**  
CERTIFIED

\*25 lat gwarancji oraz certyfikat TÜV M+T (Monitoring + Testing) posiadają wybrane produkty NEO – szczegóły na stronie neo-tools.com  
\*Selected NEO products feature a 25-year warranty and a TÜV M+T (Monitoring + Testing) certificate – you can find details at neo-tools.com  
\*Некоторые товары NEO имеют 25-летнюю гарантию и сертификат TÜV M+T (Monitoring + Testing) – подробная информация доступна на сайте neo-tools.com

**MŁOTEK ŚLUSARSKI / MACHINIST HAMMER /  
МОЛОТОК СТОЛЯРНЫЙ**

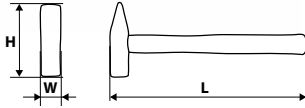

Ref.	m [g]	H [mm]	L [mm]	W [mm]	☐	EAN
25-143	300	100	295	22	6/24	5907558448368
25-145	500	115	325	27	6/24	5907558448382
25-146	800	130	355	32	6/12	5907558448399
25-147	1000	135	355	35	6/12	5907558448405

**MŁOTEK ŚLUSARSKI / MACHINIST'S HAMMER /  
МОЛОТОК СТОЛЯРНЫЙ**

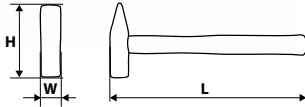

Ref.	m [g]	H [mm]	L [mm]	W [mm]	☐	EAN
25-013	300	300	105	23	1/36	5907558400427
25-015	500	315	118	29	1/36	5907558400434
25-018	800	345	130	35	1/24	5907558400441
25-020	1000	355	135	35	1/12	5907558400458

**PRZECINAK Z OCHRONIACZEM / COLD CHISEL WITH  
GUARD / ЗУБИЛО**



Ref.	L [mm]	ø [mm]	W [mm]	☐	EAN
33-081	300	18	22	6/24	5907558413144
33-082	300	18	35	6/24	5907558413151
33-083	300	18	50	6/24	5907558413168

**PRZECINAK / COLD CHISEL / ЗУБИЛО**



Ref.	L [mm]	W [mm]	☐	EAN
33-072	150	10	10/200	5907558413304
33-073	150	13	10/200	5907558413311
33-074	150	16	10/100	5907558413328

**ŁOM WIELOFUNKCYJNY / MULTIFUNCTIONAL  
CROWBAR / БАГАТОФУНКЦІОНАЛЬНИЙ ЛОМ**



Ref.	☐	EAN
29-100	6/36	5907558463613
29-101	6/36	5907558463620

**ZESTAW WYBIJAKÓW, PRZECINAKÓW I PUNKTAKÓW /  
PIN PUNCH, CHISEL AND CENTRE PUNCH SET / НАБОР  
ИНСТРУМЕНТОВ**



Ref.	L [mm]	☐	EAN
33-061	300	6/36	5907558413205

**ZESTAW WYBIJAKÓW, PRZESINAKÓW I PUNKTAKÓW /  
PIN PUNCH, CHISEL AND CENTRE PUNCH SET / НАБОР  
ИНСТРУМЕНТОВ**



**CrV**  
steel **x12**

Ref.	W [mm]	☐	EAN
33-062	300	6/12	5907558413212

**PILNIKI DO METALU / STEEL FILE SET / НАПИЛЬНИКИ  
ПО МЕТАЛЛУ /**



**SUPER HARD**  
**T12**  
steel **2**



Ref.	W [mm]	☐	EAN
37-610	200	4/16	5907558407433

**UCHWYT DO BRZESZCZOTU / HACKSAW BLADE  
HOLDER / ДЕРЖАТЕЛЬ ДЛЯ ПОЛОТНА НОЖОВКИ**



**BI-MATERIAL  
HANDLE**

Ref.	L [mm]	☐	EAN
43-320	300	5/20	5907558447170

**SZRACHLA MALARSKA / SCRAPER / ШПАТЕЛЬ  
МАЛЯРНЫЙ**



**STAINLESS  
STEEL**

Ref.	L [mm]	☐	EAN
50-353	50	12/120	5902062062666
50-354	63	12/120	5902062062673
50-355	75	12/120	5902062062680
50-356	100	12/120	5902062062697
50-357	125	12/120	5902062062703

**IMADŁO ŚLUSARSKIE / PRECISION BENCH VICE /  
ТИСКИ**



**TÜVRheinland  
CERTIFIED**



Ref.	W [mm]	Ra [mm]	☐	EAN
35-015	150	147	0/1	5907558400786

**PIŁA DO METALU / HACKSAW FRAME / НОЖОВКА ПО  
МЕТАЛЛУ**



**BI-MATERIAL  
HANDLE**

Ref.	W [mm]	☐	EAN
43-302	300	1/24	5907558447156

**NEO  
TOOLS**

**25**  
years  
GUARANTEE

**TÜVRheinland  
CERTIFIED**

\*25 lat gwarancji oraz certyfikat TÜV M+T (Monitoring + Testing) posiadają wybrane produkty NEO – szczegóły na stronie neo-tools.com  
\*Selected NEO products feature a 25-year warranty and a TÜV M+T (Monitoring + Testing) certificate – you can find details at neo-tools.com  
\*Некоторые товары NEO имеют 25-летнюю гарантию и сертификат TÜV M+T (Monitoring + Testing) – подробная информация доступна на сайте neo-tools.com

**PIŁA DO METALU / HACKSAW FRAME / НОЖОВКА ПО МЕТАЛЛУ**



150 mm

BI-MATERIAL HANDLE

Ref.	W [mm]	☐	EAN
43-310	150	10/60	5907558447163

**NIOTOWNICA DO NITÓW STALOWYCH I ALUMINIOWYCH / RIVETER FOR STEEL AND ALUMINIUM RIVETS / ЗАКЛЕПОЧНИК ДЛЯ ЗАКЛЕПОК СТАЛЬНЫХ И АЛЮМИНИЕВЫХ**



Steel	Ø [mm]
	2,4/3,0/3,2/4,0/4,8/5,0 mm
Cu	Ø [mm]
	2,4/3,0/3,2/4,0/4,8/5,0 mm

Al	Ø [mm]
	2,4/3,0/3,2/4,0/4,8/5,0 mm
Stainless Steel	Ø [mm]
	2,4/3,0/3,2/4,0 mm

Ref.	Ø [mm]	L [mm]	☐	EAN
18-101	2,4/3,2/4,0/4,8	264	10/30	5907558400137

**NIOTOWNICA DO NITÓW STALOWYCH I ALUMINIOWYCH / RIVETER FOR STEEL AND ALUMINIUM RIVETS / ЗАКЛЕПОЧНИК ДЛЯ ЗАКЛЕПОК СТАЛЬНЫХ И АЛЮМИНИЕВЫХ**



Steel	Ø [mm]
	2,4/3,0/3,2/4,0/4,8/5,0 mm
Cu	Ø [mm]
	2,4/3,0/3,2/4,0/4,8/5,0 mm

Al	Ø [mm]
	2,4/3,0/3,2/4,0/4,8/5,0 mm
Stainless Steel	Ø [mm]
	2,4/3,0/3,2/4,0/4,8/5,0 mm

Ref.	Ø [mm]	L [mm]	☐	EAN
18-103	2,4/3,2/4,0/4,8	265	10/30	5907558405811

**ZSZYWACZ TAPICERSKI / HAND STAPLER / СТЕПЛЕР**



Ref.	☐	EAN
16-032	6/24	5907558454703

**ZSZYWACZ TAPICERSKI / HAND STAPLER / СТЕПЛЕР**



Ref.	☐	EAN
16-030	6/12	5907558454680

**ZSZYWACZ TAPICERSKI / HAND STAPLER / СТЕПЛЕР**



Ref.	☐	EAN
16-031	6/24	5907558454697

**PISTOLET KLEJOWY / GLUE GUN / ПИСТОЛЕТ  
КЛЕЕВОЙ ЭЛЕКТРИЧЕСКИЙ**



Ref.	Ø [mm]	☐	EAN
17-083	11	0/10	5907558462524

**PISTOLET KLEJOWY / GLUE GUN / ПИСТОЛЕТ  
КЛЕЕВОЙ ЭЛЕКТРИЧЕСКИЙ**



Ref.	Ø [mm]	P [W]	☐	EAN
17-096	11	60	12/36	5907558465679
17-097	11	100	12/36	5907558465693

**POZIOMNICA / SPRIT LEVEL / УРОВЕНЬ**



Ref.	L [cm]	☐	EAN
71-030	20	0/30	5907558410433

**PISTOLET KLEJOWY / GLUE GUN / ПИСТОЛЕТ  
КЛЕЕВОЙ ЭЛЕКТРИЧЕСКИЙ**



Ref.	Ø [mm]	☐	EAN
17-090	11	12/48	5907558465686

**POZIOMNICA Z WYŚWIETLACZEM ELEKTRONICZNYM  
/ DIGITAL LEVEL / УРОВЕНЬ С ЭЛЕКТРОННЫМ  
ДИСПЛЕЕМ**



Ref.	L [cm]	☐	EAN
71-200	60	0/20	5907558455250

**TAŚMA MIERNICZA STALOWA / MEASURING TAPE /  
ЛЕНТА ИЗМЕРИТЕЛЬНАЯ СТАЛЬНАЯ**



Ref.	L [mm]	W [mm]	☐	EAN
68-120	20	9,5	12/48	5907558406719
68-130	30	9,5	12/48	5907558406726

**NEO  
TOOLS**

**25  
years  
GUARANTEE**

**TÜVRheinland  
CERTIFIED**

\*25 lat gwarancji oraz certyfikat TÜV M+T (Monitoring + Testing) posiadają wybrane produkty NEO – szczegóły na stronie neo-tools.com  
\*Selected NEO products feature a 25-year warranty and a TÜV M+T (Monitoring + Testing) certificate – you can find details at neo-tools.com  
\*Некоторые товары NEO имеют 25-летнюю гарантию и сертификаты TÜV M+T (Monitoring + Testing) – подробная информация доступна на сайте neo-tools.com



Ref.	L [mm]	W [mm]	☐	EAN
67-112	2	16	12/120	5907558400052
67-113	3	19	12/72	5907558400069
67-115	5	25	12/72	5907558400076
67-111	8	25	6/48	5907558400045



Ref.	L[mm]	Ra[mm]	☐	EAN
03-015	150	0-34	6/96	5907558412208
03-014	200	0-38	6/72	5907558404159
03-016	250	0-50	5/30	5907558412215

SUWMIARKA / VERNIER CALIPER / ШТАНГЕНЦИРКУЛЬ

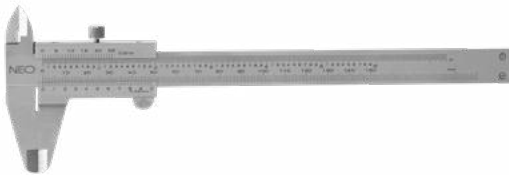

Ref.	L [mm]	Ra [mm]	☐	EAN
75-000	234	0-150	10/10	5907558406757

GRZECHOTKA / RATCHET / КЛЮЧ ТРЕЩОТЧЫЙ



Ref.	Info	L [mm]	☐	EAN
08-540	1/4"	155	5/50	5907558435719
08-546	1/2"	250	5/20	5907558435733

SUWMIARKA CYFROWA / DIGITAL CALIPER / ШТАНГЕНЦИРКУЛЬ ЦИФРОВОЙ



Ref.	L [mm]	Ra [mm]	☐	EAN
75-011	237	0-150	5/25	5907558408614

PRZEDŁUŻKA ELASTYCZNA / FLEXIBLE EXTENSION BAR / УДЛИНИТЕЛЬ ГИБКИЙ



Ref.	Info	L[mm]	M <sub>0</sub> max[Nm]	☐	EAN
08-557	1/4"	140	5	25/100	5907558402667
08-558	1/2"	190	40	10/80	5907558402674

# KLUCZE NASADOWE / SPHERICAL SPLINE SOCKET SET / НАБОР СМЕННЫХ ГОЛОВОК



25 years  
GUARANTEE

CrV  
steel

S2  
steel

1/2"

1/4"

x71

SPLINE

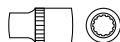

1/2" SPLINE - 10 / 11 / 12 / 13 / 14 / 15 / 16 / 17 / 18 / 19 / 20 / 21 / 22 / 23 / 24 / 27 / 30 / 32

1/4" SPLINE - 4 / 4.5 / 5 / 5.5 / 6 / 7 / 8 / 9 / 10 / 11 / 12 / 13

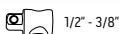
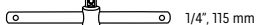

1/4 - TT - 10 / 15 / 20 / 25 / 27 / 30 / 40

PZ - 1 / 2 / 3

PH - 1 / 2 / 3

SL - 4.5 / 6.5 / 8 mm

HEX - 3 / 4 / 5 / 6 / 7 / 8 mm

# 71

ELEMENTS

Ref.	Case	EAN
08-690	0/4	5907558440010



**NEO**  
TOOLS

25 years  
GUARANTEE

TÜVRheinland  
CERTIFIED

\* 25 lat gwarancji oraz certyfikat TÜV M+T (Monitoring + Testing) posiadają wybrane produkty NEO – szczegóły na stronie neo-tools.com

\* Selected NEO products feature a 25-year warranty and a TÜV M+T (Monitoring + Testing) certificate – you can find details at neo-tools.com

\* Некоторые товары NEO имеют 25-летнюю гарантию и сертификаты TÜV M+T (Monitoring + Testing) – подробная информация доступна на сайте neo-tools.com



KLUCZE NASADOWE / SPHERICAL SPLINE SOCKET SET / НАБОР СМЕННЫХ ГОЛОВОК



25  
years  
GUARANTEE

CrV  
steel

1/2" x33

SUPERLOCK

90

STRONG  
CASE

ERGO

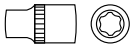

1/2" SUPERLOCK - 8 / 9 / 10 / 11 / 12 / 13 / 14 / 15 / 16 / 17 / 18 / 19 / 20 / 21 / 22 / 23 / 24 / 25 / 26 / 27 / 28 / 29 / 30 / 32 / 34 / 35 / 36

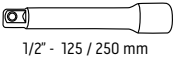

1/2" - 125 / 250 mm



1/2" - 3/8"



1/2"



1/2", 90T

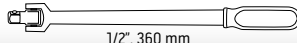

1/2", 360 mm

33  
ELEMENTS

Ref.	Case	EAN
08-692	0/4	5907558440027

KLUCZE NASADOWE / SPHERICAL SPLINE SOCKET SET / НАБОР СМЕННЫХ ГОЛОВОК



25  
years  
GUARANTEE

CrV  
steel

1/2" x23

SUPERLOCK

90

STRONG  
CASE

ERGO



1/2" SUPERLOCK - 8 / 10 / 11 / 12 / 13 / 14 / 15 / 16 / 17 / 18 / 19 / 21 / 22 / 24 / 27 / 30 / 32

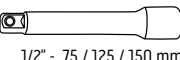

1/2" - 75 / 125 / 150 mm



1/2" - 3/8"



1/2", 90T



1/2"

23  
ELEMENTS

Ref.	Case	EAN
08-694	0/5	5907558440034

## KLUCZE SZEŚCIOKĄTNE / RAINBOW EXTRA LONG HEX KEY SET WITH HOLDER / КЛЮЧИ ШЕСТИГРАННЫЕ



25 years  
GUARANTEE



SUPER HARD  
SNMC+V  
steel

x9

DIN  
911

ISO  
2936



⊙	L[mm]	L <sub>1</sub> [mm]
1.5	91	16
2.0	103	19
2.5	115	20
3.0	130	23
4.0	145	29

⊙	L[mm]	L <sub>1</sub> [mm]
5.0	166	35
6.0	188	38
8.0	208	43
10.0	230	50

Ref.	☐	EAN
09-512	6/48	5907558403428

## KLUCZE PIĘCIOKĄTNE / 5 POINTS EXTRA LONG STAR KEY / КЛЮЧИ ЗВЕЗДОЧКИ



25 years  
GUARANTEE

S2  
steel

x9



★	L[mm]	L <sub>1</sub> [mm]
TS10	92	18
TS15	113	20
TS20	116	23
TS25	130	25
TS27	145	30

★	L[mm]	L <sub>1</sub> [mm]
TS30	165	35
TS40	186	40
TS45	208	45
TS50	232	50

Ref.	☐	EAN
09-520	1/36	5907558410280

## KLUCZE SZEŚCIOKĄTNE, DŁUGIE, KULISTE / HEX KEYS / КЛЮЧИ ШЕСТИГРАННЫЕ ДЛИННЫЕ, ШАРОВИДНЫЕ НАКОНЕЧНИКИ



25 years  
GUARANTEE

CrV  
steel

x8

ISO  
2936



⊙	L[mm]	L <sub>1</sub> [mm]
2.0	85	18
2.5	90	20
3.0	97	23
4.0	106	28

⊙	L[mm]	L <sub>1</sub> [mm]
5.0	118	30
6.0	138	36
8.0	159	40
10.0	180	46

Ref.	☐	EAN
09-523	10/40	5907558414288

## KLUCZE TORX DŁUGIE / TORX KEYS / КЛЮЧИ ШЕСТИГРАННЫЕ TORX



25 years  
GUARANTEE

CrV  
steel

x8



⊙	L[mm]	L <sub>1</sub> [mm]
TT10	88	20
TT15	93	22
TT20	98	23
TT25	105	24

⊙	L[mm]	L <sub>1</sub> [mm]
TT30	119	30
TT40	130	32
TT45	144	37
TT50	160	40

Ref.	☐	EAN
09-524	10/40	5907558414295

**NEO**  
TOOLS

25 years  
GUARANTEE



\*25 lat gwarancji oraz certyfikat TÜV M+T (Monitoring + Testing) posiadają wybrane produkty NEO – szczegóły na stronie neo-tools.com

\*Selected NEO products feature a 25-year warranty and a TÜV M+T (Monitoring + Testing) certificate – you can find details at neo-tools.com

\*Некоторые товары NEO имеют 25-летнюю гарантию и сертификат TÜV M+T (Monitoring + Testing) – подробная информация доступна на сайте neo-tools.com

**KLUCZE SZEŚCIOKĄTNE Z KOŃCÓWKĄ KULISTĄ, Z  
MAGNESEM / HEX KEYS / КЛЮЧИ ШЕСТИГРАННЫЕ**

**KLUCZE PŁASKO-OCZKOWE / COMBINATION SPANNER  
SET / КЛЮЧИ КОМБИНИРОВАННЫЕ**



**25**  
years  
GUARANTEE

**CrV**  
steel

**x9**

**DIN**  
911

**ISO**  
2936



⌀	L[mm]	L <sub>1</sub> [mm]
1.5	92	15
2.0	100	18
2.5	114	20
3.0	127	22
4.0	143	28

⌀	L[mm]	L <sub>1</sub> [mm]
5.0	164	31
6.0	185	37
8.0	205	43
10.0	235	47

Ref.	📦	EAN
09-525	6/24	5907558414301

**LUSTERKO INSPEKCYJNE TELESKOPOWE /  
TELESCOPIC INSPECTION MIRROR / ЗЕРКАЛО  
ИНСПЕКЦИОННОЕ**



**170 - 490**  
mm

**30**  
mm

Ref.	📦	EAN
11-612	0/200	5907558418583



**25**  
years  
GUARANTEE

**TÜV Rheinland**  
CERTIFIED

**CrV**  
steel

**DIN**  
3113



Ref.	⊘[mm]	📦	EAN
09-751	6, 8, 10, 12, 13, 14, 17, 19 mm	0/25	5907558411522
09-752	6, 7, 8, 10, 11, 12, 13, 14, 15, 17, 19, 22 mm	0/20	5907558411539
09-753	8, 9, 10, 11, 12, 13, 14, 15, 16, 17, 18, 19, 22, 24, 27, 30, 32 mm	0/6	5907558413106
09-754	6, 7, 8, 9, 10, 11, 12, 13, 14, 15, 16, 17, 18, 19, 20, 21, 22, 23, 24, 25, 26, 27, 28, 29, 30, 32 mm	0/4	5907558413113



# SKRZYŃKA NARZĘDZIOWA / TOOL BOX / ЯЩИК ДЛЯ ИНСТРУМЕНТА

super wytrzymałe, pojemne poliwęglanowe pokrywy organizerów  
super-strong polycarbonate covers of the organizers  
очень прочные крышки органайзеров из поликарбоната

solidne aluminiowe zapiecia  
sturdy aluminium clamps  
прочные алюминиевые защелки

możliwość oparcia górnej pokrywy na uchwycie  
upper cover can rest on the handle  
можно опереть верхнюю крышку о ручку



możliwość zapiecia na kłódke  
possible to lock with a padlock  
можно закрыть на навесной замок



dwupoziomowa, rozkładana tacka  
two layers folding tray  
двухуровневый, раскладной лоток

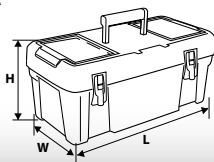

Ref.	L [mm]	W [mm]	H [mm]	☐	EAN
84-102	460	240	255	0/1	5907558409574
84-105	545	280	270	0/1	5907558408683



metalowe trzpienia w zawiasach zwiększające  
żywność skrzyńki  
metal pins in hinges improve tool box lifetime  
петли на металлических стержнях  
увеличивают срок службы ящика

pojemne organizery z super wytrzymałymi  
poliwęglanowymi pokrywami  
super-strong polycarbonate covers of the  
organizers  
очень прочные крышки органайзеров из  
поликарбоната



plastikowe narożniki powleczone gumą zabezpieczają skrzyńkę przed uszkodzeniem  
oraz przesuwaniami się  
plastic and rubber coated corners protect the tool box from damages and prevent  
shifting

пластмассовые уголки с резиновым покрытием предохраняют ящик от  
повреждения и предотвращают его перемещение



możliwość zapiecia na kłódke  
possible to lock with a padlock  
можно закрыть на навесной замок

Ref.	L [mm]	W [mm]	H [mm]	☐	EAN
84-114	495	360	710	0/1	5907558439182

**NEO**  
TOOLS

**25**  
years  
GUARANTEE

**TÜVRheinland**  
CERTIFIED

## SKRZYŃKA NARZĘDZIOWA NA KOŁACH / MOBILE WORKSHOP / МОБИЛЬНАЯ МАСТЕРСКАЯ



4 x organizer w pokrywie  
4 organizers in the cover  
4 x организера в крышке



modułowa budowa (pojemna skrzynka + moduł 4 x Ergobox 2 Plus + pojemnik na elektronarzędzia) – pozwala na transport zróżnicowanych materiałów modular design (spacious box + 4 x Ergobox 2 Plus module + container for power tools)

модульная конструкция (вместительный ящик + модуль 4 x Ergobox 2 Plus + контейнер для электроинструмента)



4 zamknięte pojemniki  
4 closing containers  
4 закрывающихся контейнера



solidny system jezdny z metalową osią i kołami zabezpieczonymi warstwą gumy pozwala na pracę nawet w ekstremalnych warunkach  
sturdy wheels system with metal axis and rubber layer protecting the wheels  
прочные колеса с резиновым покрытием, посаженные на металлическую ось

Ref.	L [mm]	W [mm]	H [mm]		EAN
84-115	495	360	710	0/1	5907558421682

## SKRZYŃKA NARZĘDZIOWA NA KOŁACH / WHEELBOX / ЯЩИК ДЛЯ ИНСТРУМЕНТОВ НА КОЛЕСАХ



duży organizer z regulowanymi przegrodami umiejscowiony na pokrywie skrzynki  
large organiser with adjustable compartments  
большой организер с регулируемыми перегородками



alumiiniowa teleskopowa rączka  
aluminium telescopic handle  
алюминиевая телескопическая ручка



solidny system jezdny z kołami zabezpieczonymi warstwą gumy  
sturdy wheels system with rubber layer protecting the wheels  
прочные колеса с резиновым покрытием

mobilna skrzynka narzędziowa o dużej ładowności  
mobile tool box with high capacity  
мобильный ящик для инструмента большой вместимости



metalowe zapięcia pozwalają na bezpieczny transport ciężkiego ładunku  
metal clamps allow for safe transport of heavy loads  
металлические защелки обеспечивают безопасную транспортировку тяжелого груза

Ref.	L [mm]	W [mm]	H [mm]		EAN
84-116	680	400	355	0/1	5907558421699

# ORGANIZER Z REGULOWANYMI PRZEGRODAMI / ORGANIZER / ЯЩИК ДЛЯ КРЕПЕЖА (ОРГАНАЙЗЕР)

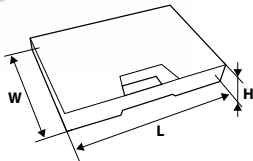
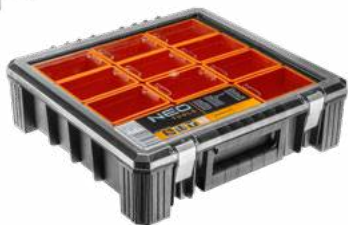

Ref.	L [mm]	W [mm]	H [mm]	☐	EAN
84-118	390	290	65	0/1	5907558439229
84-119	490	390	65	0/1	5907558439236

Ref.	L [mm]	W [mm]	H [mm]	☐	EAN
84-130	400	400	120	0/1	5907558431216
84-131	390	600	110	0/1	5907558431223

## TORBA MONTERSKA / TOOL BAG WITH TUBULAR HANDLE / МОНТЕРСКАЯ СУМКА



32 kieszenie wewnętrzne  
32 inside pockets  
32 внутренних кармана



12 kieszeni zewnętrznych  
12 outer pockets  
12 наружных кармана

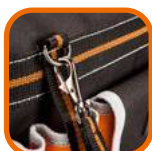

Klamra i karabinek na narzędzia  
Buckle and carabiner for tools  
Кольцо и карабин для инструмента



Mocna, sztywna konstrukcja  
Strong and rigid construction  
Крепкая, жесткая конструкция



Zaczerp na miarkę  
Hook for pocket rule  
Скоба для линейки



Dwie pakowne komory główne  
Two spacious main compartments  
Два удобных главных отдела



Okienko na personalizowaną etykietę  
Inset for personalized label  
Прозрачный карман для идентификационной карты



5 gumowych, antypoślizgowych podstawek  
5 rubber, anti-slip stands  
5 резиновых антискользящих накладок



Wzmocniony, wytrzymały materiał - Poliester  
Strengthened, durable fabric - polyester  
Усиленный, прочный материал - Полиэстер

Ref.	☐	EAN
84-301	0/2	5907558425802

**NEO**  
TOOLS

**25**  
years  
GUARANTEE

**TÜV**Rheinland  
CERTIFIED

\*25 lat gwarancji oraz certyfikat TÜV M+T (Monitoring + Testing) posiadają wybrane produkty NEO – szczegóły na stronie neo-tools.com  
\*Selected NEO products feature a 25-year warranty and a TÜV M+T (Monitoring + Testing) certificate – you can find details at neo-tools.com  
\*Некоторые товары NEO имеют 25-летнюю гарантию и сертификат TÜV M+T (Monitoring + Testing) – подробная информация доступна на сайте neo-tools.com

**TORBA NARZĘDZIOWA / TOOL BAG / СУМКА ДЛЯ ИНСТРУМЕНТА**

**20"**  
**NYLON 600D**



**TORBA NARZĘDZIOWA / TOOL BAG / СУМКА ДЛЯ ИНСТРУМЕНТА**

**NYLON 600D**



Ref.		EAN
84-300	0/4	5907558417258

Ref.	Size		EAN
84-305	40 x 22 x 33 cm	0/6	5907558417265

**TORBA MONTERSKA / TOOL BAG WITH TUBULAR HANDLE / МОНТЕРСКАЯ СУМКА**



Uchwyt do przenoszenia  
Carrying handle  
Специальная ручка для переноски



2 kieszenie zewnętrzne  
2 inside pockets  
2 наружных карманов



Wymowiana przegroda komory głównej  
Removable mainchamber bulkhead  
Съемная перегородка главного отделения



Dedykowane uchwyty na klucze płaskooczkowe  
Dedicated hooks for spanners  
Специальные крепления для гаечных ключей



Regulowany pasek na ramię  
Adjustable arm belt  
Регулируемый плечевой ремень



Dedykowane uchwyty na wkrętaki  
Dedicated screwdrivers hooks  
Специальные крепления для отверток



17 kieszeni wewnętrznych  
17 inside pockets  
17 внутренних карманов



Zabezpieczające podstawki  
Safety stands  
Предохраняющие подставки



Ref.		EAN
84-308	0/4	5907558427745

## TORBA MONTERSKA / TOOL BAG WITH TUBULAR HANDLE / МОНТЕРСКАЯ СУМКА



Wzmocniony, teleskopowy uchwyt z blokadą do holowania torby  
Reinforced telescopic handle with lock for towing bag  
Усиленная, телескопическая ручка с блокировкой для перемещения сумки



Sztywna konstrukcja  
Rigid construction  
Жесткая конструкция



Wzmocniony, wytrzymały materiał - Poliester  
Strengthened, durable fabric - polyester  
Усиленный, прочный материал - Полиэстер



6 wewnętrznych kieszeni  
6 inside pockets  
6 внутренних карманов



11 zewnętrznych kieszeni  
11 outer pockets  
11 наружных карман



Wytrzymałe, masywne koła  
Strengthened, massive wheels  
Прочные, массивные колеса



Podwójny, wzmocniony szew zamka  
Reinforced double seam zipper  
Двойной, усиленный шов застежки-молнии



Trwałe uchwyty wzmocnione nitami  
Durable handles reinforced by rivets  
Надежные ручки, укрепленные заклепками



Uchwyt do przenoszenia torby  
Carrying handle  
Ручка для переноски сумки

Ref.	0/2	EAN
84-302	0/2	5907558425819

## TORBA NARZĘDZIOWA Z UCHWYTEM / TOOL BAG / СУМКА ДЛЯ ИНСТРУМЕНТА



Uchwyt do przenoszenia  
Profiled handle  
Профилированная ручка



Regulowany pasek na ramię  
Adjustable arm belt  
Регулируемый плечевой ремень



Rozkładana konstrukcja  
Folding construction  
Раскладывающаяся конструкция



Pojemna komora główna  
Spacious main compartment  
Вместительный главный отдел



4 kieszenie zewnętrzne  
4 zip fastened outer pockets  
4 наружных кармана на молнии



4 kieszenie wewnętrzne  
4 inside pockets  
4 внутренних кармана



Zacpek na pasek  
Belt hanger  
Скоба для крепления на пояском ремне



Wewnętrzne zacpepy na narzędzia  
Tool holders inside  
Внутренние скобы для инструментов



Ref.	0/35	EAN
84-315	0/35	5907558428391

**NEO**  
TOOLS

**25**  
years  
GUARANTEE

**TÜV**Rheinland  
CERTIFIED

\* 25 lat gwarancji oraz certyfikat TÜV M+T (Monitoring + Testing) posiadają wybrane produkty NEO – szczegóły na stronie neo-tools.com  
\* Selected NEO products feature a 25-year warranty and a TÜV M+T (Monitoring + Testing) certificate – you can find details at neo-tools.com  
\* Некоторые товары NEO имеют 25-летнюю гарантию и сертификат TÜV M+T (Monitoring + Testing) – подробная информация доступна на сайте neo-tools.com



## PLECAK MONTERSKI / TOOLS BAGPACK / РЮКЗАК МОНТЕРСКИЙ



Miękkie, oddychające poduszki na plecach  
Soft and breathable cushions on the back  
Мягкие, „дышащие” подушки на спинке



Uchwyt do przenoszenia plecaka  
Handle for carrying the backpack  
Ручка для переноски рюкзака



Profilowane, regulowane pasy nośne  
Profiled, adjustable carrying straps  
Профилированные, регулируемые плечевые ремни



18 kieszeni wewnętrznych  
18 inside pockets  
18 внутренних карманов



Regulowane, rozpinane pasy  
Adjustable zippered straps  
Регулируемые, расстегивающиеся ремни



4 kieszenie zewnętrzne  
4 outer pockets  
4 наружных кармана



Regulowany, rozpinany pas piersiowy  
Adjustable, zippered chest strap  
Регулируемый, расстегивающийся нагрудный ремень



Wzmocniony, wytrzymały materiał - Poliester  
Strengthened, durable fabric - polyester  
Усиленный, прочный материал - Полиэстер



Kieszka na laptopa  
Place for laptop  
Карман для ноутбука



Ref.		EAN
84-304	0/6	5907558425833

## SASZETKA / SACHET / САШЕ



2 pojemne komory główne  
Two spacious main compartments  
2 удобных главных отдела



1 kieszeń zewnętrzna  
1 outer pocket  
1 внешний карман



Regulowany pasek  
Adjustable belt  
Регулируемый ремень



Trwale zamki  
Strengthened zippers  
Прочные застежки-молнии



3 kieszenie wewnętrzne  
3 inside pockets  
3 внутренних кармана

Ref.		EAN
84-311	0/30	5907558428377

## PAS MONTERSKI / SPLICER BELT / ПОЯС ДЛЯ ИНСТРУМЕНТА



Ref.		EAN
84-330	0/5	5907558415667

## REKAWICE ANTYPRZECIEŚCIOWE / CUT PROTECTION GLOVES / ПЕРЧАТКИ ЗАЩИЩАЮЩИЕ ОТ ПРОКОЛА

- 4 - Odporność na ścieranie (od 0 do 4)
- X - Odporność na przecięcie ostrym przedmiotem (nie ma zastosowania)
- 4 - Odporność na rozdzielanie (od 0 do 4)
- 3 - Odporność na przekłucie (od 0 do 4)
- D - Odporność na przecięcie wg EN ISO 13997



Ref.	Size ["]	☐	EAN
97-609-8	8	12/120	5907558447934
97-609-9	9	12/120	5907558447941
97-609-10	10	12/120	5907558447958

## KASK OCHRONNY / SAFETY HELMET / КАСКА ЗАЩИТНАЯ



Ref.	Color	☐	EAN
97-200	Yellow	35/105	5907558467345
97-201	White	35/105	5907558467352
97-202	Blue	35/105	5907558467369
97-203	Green	35/105	5907558467376
97-204	Red	35/105	5907558467383
97-205	Orange	35/105	5907558467390

## REKAWICE ROBOCZE / WORKING GLOVES / ПЕРЧАТКИ РАБОЧИЕ

- 4 - Odporność na ścieranie (od 0 do 4)
- 1 - Odporność na przecięcie ostrym przedmiotem (od 0 do 2)
- 3 - Odporność na rozdzielanie (od 0 do 4)
- 1 - Odporność na przekłucie (od 0 do 4)
- X - Odporność na przecięcie wg EN ISO 13997



Ref.	Size ["]	☐	EAN
97-616-8	8"	10/100	5907558447996
97-616-9	9"	10/100	5907558448009
97-616-10	10"	10/100	5907558448016

## OKULARY OCHRONNE / SAFETY GLASSES / ОЧКИ ЗАЩИТНЫЕ



Ref.	☐	EAN
97-500	6/72	5907558406887

## OKULARY OCHRONNE / SAFETY GLASSES / ОЧКИ ЗАЩИТНЫЕ



Ref.	☐	EAN
97-501	6/72	5907558406894

**NEO**  
TOOLS

**25**  
years  
GUARANTEE

**TÜV**Rheinland  
CERTIFIED

\* 25 lat gwarancji oraz certyfikat TÜV M+T (Monitoring + Testing) posiadają wybrane produkty NEO – szczegóły na stronie neo-tools.com  
\* Selected NEO products feature a 25-year warranty and a TÜV M+T (Monitoring + Testing) certificate – you can find details at neo-tools.com  
\* Некоторые товары NEO имеют 25-летнюю гарантию и сертификаты TÜV M+T (Monitoring + Testing) – подробная информация доступна на сайте neo-tools.com



Ref.	Color	EAN
97-505		5907558483147
97-506		5907558483154
97-507		5907558483161

BLUZA ROBOCZA / WORKING JACKET / БЛУЗА РАБОЧАЯ

- wysokiej jakości materiał (65% poliester, 35% bawełna) o gramaturze 267 g/m<sup>2</sup>
- wzmocnienia z tkaniny Oxford na łokciach i barkach
- element odblaskowy wokół klatki piersiowej poprawiający bezpieczeństwo użytkownika
- CE, zgodność z normą EN ISO 13688:2013

- high quality fabric: 65% polyester, 35% cotton with 267 g/m<sup>2</sup> grammage
- reinforcements with Oxford fabric on elbows and shoulders
- reflective tapes on chest and at back for improve user's safety
- CE, EN ISO 13688:2013 compliant

- высококачественный материал 65% полиэстер 35% хлопок плотностью 267 г/м<sup>2</sup>
- усиления на локтях и плечах из ткани "Оксфорд"
- светоотражающая вставка вокруг груди для повышения безопасности
- CE-маркировка, соответствие требованиям стандарта EN ISO 13688:2013



Strefy odblaskowe  
Reflective tape  
Световозвращающие вставки



Kieszonka na smartphona  
Smartphone pocket  
Многофункциональные карманы



Otwory wentylacyjne  
Side ventilation  
Вентиляционные отверстия для воздухообмена



Ref.	Size	☐	EAN
81-210-S	S/48	0/10	5907558419023
81-210-M	M/50	0/10	5907558419030
81-210-L	L/52	0/10	5907558419047
81-210-LD	L/54	0/10	5907558419054
81-210-XL	XL/56	0/10	5907558419061
81-210-XXL	XXL/58	0/10	5907558419078

## SPODNIE ROBOCZE / WORKING TROUSERS / БРЮКИ РАБОЧИЕ

- wysokiej jakości materiał (65% poliester, 35% bawełna) o gramaturze 267 g/m<sup>2</sup>
- wzmocnienia z tkaniny Oxford na kolanach
- wytrzymały, potrójny szew w miejscach narażonych na rozdarcie
- możliwość używania z piankowymi wkładkami na kolana
- CE, zgodność z normą EN ISO 13688:2013

- high quality fabric: 65% polyester, 35% cotton with 267 g/m<sup>2</sup> grammage
- reinforcements with Oxford fabric on knees
- durable, triple seam in spots prone to tearing
- can be used with knee foam pads
- CE, EN ISO 13688:2013 compliant

- высококачественный материал 65% полиэстер, 35% хлопок плотностью 267 г/м<sup>2</sup>
- усиления на коленях из ткани "Оксфорд"
- прочный, тройной шов в местах, подверженных разрыву
- можно носить с поролоновыми вставками на колени
- CE-маркировка, соответствие требованиям стандарта EN ISO 13688:2013



Kieszeń na smartphona  
Smartphone pocket  
Многофункциональные карманы



Wzmocniony materiał na kolanach  
Reinforced fabric on knees  
Усиления на коленях



Miejsce na wkładki ochronne  
Pocket for knee pads  
Карманы для вкладышей на колени



Dodatkowa regulacja rozmiaru w pasie  
Additional belt size adjustment  
Дополнительная регулировка размера пояса



Uchwyt do narzędzi  
Tool holder  
Петли для инструмента



Ref.	Size	☐	EAN
81-220-S	S/48	0/10	5907558419085
81-220-M	M/50	0/10	5907558419092
81-220-L	L/52	0/10	5907558419108
81-220-LD	L/54	0/10	5907558419115
81-220-XL	XL/56	0/10	5907558419122
81-220-XXL	XXL/58	0/10	5907558419139

## SPODNIE ROBOCZE / WORKING TROUSERS / БРЮКИ РАБОЧИЕ

- wysokiej jakości materiał (65% poliester, 35% bawełna) o gramaturze 267 g/m<sup>2</sup>
- wzmocnienia z tkaniny Oxford na kolanach
- wytrzymały, potrójny szew w miejscach narażonych na rozdarcie
- odpinane kieszenie
- 2 w 1 - możliwość odpięcia nogawek
- możliwość używania z piankowymi wkładkami na kolana
- CE, zgodność z normą EN ISO 13688:2013

- high quality fabric: 65% polyester, 35% cotton with 267 g/m<sup>2</sup> grammage
- reinforcements with Oxford fabric on knees
- durable, triple seam in spots prone to tearing
- detachable pockets
- 2 in 1 - detachable legs
- can be used with knee foam pads
- CE, EN ISO 13688:2013 compliant

- высококачественный материал 65% полиэстер, 35% хлопок плотностью 267 г/м<sup>2</sup>
- усиления на коленях из ткани "Оксфорд"
- прочный, тройной шов в местах, подверженных разрыву
- отстегиваемые карманы
- 2 в 1 - можно отстегнуть брючины
- можно носить с поролоновыми вставками на колени
- CE-маркировка, соответствие требованиям стандарта EN ISO 13688:2013



Kieszeń na smartphona  
Smartphone pocket  
Многофункциональные карманы



Wzmocniony materiał na kolanach  
Reinforced fabric on knees  
Усиления на коленях



Miejsce na wkładki ochronne  
Pocket for knee pads  
Карманы для вкладышей на колени



Odpinana kieszeń  
Detachable pocket  
Отстегивающийся карман



Odpinane nogawki  
Detachable legs  
Отстегивающиеся брючины



Ref.	Size	☐	EAN
81-230-S	S/48	0/10	5907558419146
81-230-M	M/50	0/10	5907558419153
81-230-L	L/52	0/10	5907558419160
81-230-LD	L/54	0/10	5907558419177
81-230-XL	XL/56	0/10	5907558419184
81-230-XXL	XXL/58	0/10	5907558419191

**NEO**  
TOOLS

**25**  
years  
GUARANTEE



\* 25 lat gwarancji oraz certyfikat TÜV M+T (Monitoring + Testing) posiadają wybrane produkty NEO - szczegóły na stronie neo-tools.com

\* Selected NEO products feature a 25-year warranty and a TÜV M+T (Monitoring + Testing) certificate - you can find details at neo-tools.com

\* Некоторые товары NEO имеют 25-летнюю гарантию и сертификат TÜV M+T (Monitoring + Testing) - подробная информация доступна на сайте neo-tools.com

## SPODNIE ROBOCZE NA SZELKACH / VIBRANTS / ПОЛУКОМБИНЕЗОН РАБОЧИЙ

- wysokiej jakości materiał (65% poliester, 35% bawełna) o gramaturze 267 g/m<sup>2</sup>
- wzmocnienia z tkaniny Oxford na kolanach
- wytrzymały, potrójny szew w miejscach narażonych na rozdarcie
- możliwość stosowania wkładek ochronnych na kolana (np. 97-530)
- CE, zgodność z normą EN ISO 13688:2013

- high quality fabric: 65% polyester, 35% cotton with 267 g/m<sup>2</sup> grammage
- reinforcements with Oxford fabric on knees
- durable, triple seam in spots prone to tearing
- can be used with knee foam pads (e.g. 97-530)
- CE, EN ISO 13688:2013 compliant

- высококачественный материал 65% полиэстер, 35% хлопок плотностью 267 г/м<sup>2</sup>
- усиления на коленях из ткани "Оксфорд"
- прочный, тройной шов в местах, подверженных разрыву
- можно носить с поролоновыми вставками на коленях (например 97-530)
- CE-маркировка, соответствие требованиям стандарта EN ISO 13688:2013



Kieszzeń na smartphona  
Smartphone pocket  
Многофункциональные карманы



Wzmocniony materiał na kolanach  
Reinforced fabric on knees  
Усиления на коленях



Miejsce na wkładki ochronne  
Pocket for knee pads  
Карманы для вкладышей на колени



Szrefy odbłaskowe  
Reflective tape  
Световозвращающие вставки



Dodatkowa regulacja w pasie  
Additional belt adjustment  
Дополнительная регулировка пояса



Ref.	Size		EAN
81-240-S	S/48	0/10	5907558419207
81-240-M	M/50	0/10	5907558419214
81-240-L	L/52	0/10	5907558419221
81-240-LD	L/54	0/10	5907558419238
81-240-XL	XL/56	0/10	5907558419245
81-240-XXL	XXL/58	0/10	5907558419252

## KOMBINEZON ROBOCZY / WORKING OVERALL / КОМБИНЕЗОН РАБОЧИЙ

- wysokiej jakości materiał (65% poliester, 35% bawełna) o gramaturze 267 g/m<sup>2</sup>
- wzmocnienia z tkaniny Oxford na łokciach, barkach i kolanach
- element odbłaskowy wokół klatki piersiowej poprawiający bezpieczeństwo użytkownika
- wytrzymały, potrójny szew w miejscach narażonych na rozdarcie
- możliwość używania z piankowymi wkładkami na kolana
- CE, zgodność z normą EN ISO 13688:2013

- high quality fabric: 65% polyester, 35% cotton with 267 g/m<sup>2</sup> grammage
- reinforcements with Oxford fabric on knees
- reflective tapes around the chest to improve user's safety
- durable, triple seam in spots prone to tearing
- can be used with knee foam pads
- CE, EN ISO 13688:2013 compliant

- высококачественный материал 35% хлопок + 65% полиэстер плотностью 267 г/м<sup>2</sup>
- усиления на коленях из ткани "Оксфорд"
- световозвращающая вставка вокруг груди для повышения безопасности
- прочный, тройной шов в местах, подверженных разрыву
- можно носить с поролоновыми вставками на коленях
- CE-маркировка, соответствие требованиям стандарта EN ISO 13688:2013



Kieszzeń na smartphona  
Smartphone pocket  
Многофункциональные карманы



Wzmocniony materiał na kolanach  
Reinforced fabric on the knees  
Усиления на коленях



Miejsce na wkładki ochronne  
Pocket for knee pads  
Место для защитных вставок



Szrefy odbłaskowe  
Reflective tape  
Световозвращающие вставки



Wzmocniony materiał na łokciach  
Reinforced fabric on elbows  
Усиления на локтях



Wielofunkcyjne kieszenie  
Multifunctional pockets  
Многофункциональные карманы



Ref.	Size		EAN
81-250-S	S/48	0/10	5907558419269
81-250-M	M/50	0/10	5907558419276
81-250-L	L/52	0/10	5907558419283
81-250-LD	L/54	0/10	5907558419290
81-250-XL	XL/56	0/10	5907558419306
81-250-XXL	XXL/58	0/10	5907558419313

## KAMIZELKA ROBOCZA / WORKING VEST / ЖИЛЕТ РАБОЧИЙ

- wysokiej jakości materiał (65% poliester, 35% bawełna) o gramaturze 267 g/m<sup>2</sup>
- wzmocnienia z tkaniny Oxford na barkach
- element odblaskowy wokół klatki piersiowej poprawiający bezpieczeństwo użytkownika
- CE, zgodność z normą EN ISO 13688:2013

- high quality fabric: 65% polyester, 35% cotton with 267 g/m<sup>2</sup>
- reinforcements with Oxford fabric on shoulders
- reflective tape around the chest to improve user's safety
- CE, EN ISO 13688:2013 compliant

- высококачественный материал 65% полиэстер, 35% хлопок плотностью 267 г/м<sup>2</sup>
- усиления на плечах из ткани "Оксфорд"
- светоотражающая вставка вокруг груди для повышения безопасности
- CE-маркировка, соответствие требованиям стандарта EN ISO 13688:2013



Strefy odblaskowe  
Reflective tape  
Светоотражающие вставки



Wzmocniony materiał na barkach  
Reinforced fabric on the shoulders  
Усиления на плечах



Wewnętrzne kieszenie  
Inner mesh pocket  
Внутренние карманы



Ref.	Size	☐	EAN
81-260-S	S/48	0/10	5907558419320
81-260-M	M/50	0/10	5907558419320
81-260-L	L/52	0/10	5907558419344
81-260-XL	XL/56	0/10	5907558419351
81-260-XXL	XXL/58	0/10	5907558419368

## PÓŁBUTY ROBOCZE / SAFETY SHOES / ПОЛУБОТИНКИ РАБОЧИЕ



Ref.	Size	Size [cm]	☐	EAN
82-150-39	39	26	0/10	5907558438086
82-150-40	40	26.7	0/10	5907558438093
82-150-41	41	27.3	0/10	5907558438109
82-150-42	42	28	0/10	5907558438116
82-150-43	43	28.7	0/10	5907558438123
82-150-44	44	29.3	0/10	5907558438130
82-150-45	45	30	0/10	5907558438147
82-150-46	46	30.7	0/10	5907558438154
82-150-47	47	31.3	0/10	5907558438161

## TRZEWIKI ROBOCZE / SAFETY BOOTS / БОТИНКИ РАБОЧИЕ



Ref.	Size	Size [cm]	☐	EAN
82-151-39	39	26	0/10	5907558437997
82-151-40	40	26.7	0/10	5907558438000
82-151-41	41	27.3	0/10	5907558438017
82-151-42	42	28	0/10	5907558438024
82-151-43	43	28.7	0/10	5907558438031
82-151-44	44	29.3	0/10	5907558438048
82-151-45	45	30	0/10	5907558438055
82-151-46	46	30.7	0/10	5907558438062
82-151-47	47	31.3	0/10	5907558438079

**NEO**  
TOOLS

**25**  
years  
GUARANTEE

TÜVRheinland  
CERTIFIED

\* 25 lat gwarancji oraz certyfikat TÜV M+T (Monitoring + Testing) posiadają wybrane produkty NEO – szczegóły na stronie neo-tools.com

\* Selected NEO products feature a 25-year warranty and a TÜV M+T (Monitoring + Testing) certificate – you can find details at neo-tools.com

\* Некоторые товары NEO имеют 25-летнюю гарантию и сертификаты TÜV M+T (Monitoring + Testing) – подробная информация доступна на сайте neo-tools.com

**RÓŁBUTY ROBOCZE / SAFETY SHOES / ПОЛУБОТИНКИ РАБОЧИЕ**



Ref.	Size	Size [cm]	☐	EAN
82-740-39	39	26	0/10	5907558437812
82-740-40	40	26.7	0/10	5907558437829
82-740-41	41	27.3	0/10	5907558437836
82-740-42	42	28	0/10	5907558437843
82-740-43	43	28.7	0/10	5907558437850
82-740-44	44	29.3	0/10	5907558437867
82-740-45	45	30	0/10	5907558437874
82-740-46	46	30.7	0/10	5907558437881
82-740-47	47	31.3	0/10	5907558437898

**TRZEWIKI ROBOCZE / SAFETY BOOTS / БОТИНКИ РАБОЧИЕ**



Ref.	Size	Size [cm]	☐	EAN
82-750-39	39	26	0/10	5907558437904
82-750-40	40	26.7	0/10	5907558437911
82-750-41	41	27.3	0/10	5907558437928
82-750-42	42	28	0/10	5907558437935
82-750-43	43	28.7	0/10	5907558437942
82-750-44	44	29.3	0/10	5907558437959
82-750-45	45	30	0/10	5907558437966
82-750-46	46	30.7	0/10	5907558437973
82-750-47	47	31.3	0/10	5907558437980

**NAGRZEWNICA / ELECTRIC HEATER / ЭЛЕКТРИЧЕСКИЙ НАГРЕВАТЕЛЬ**



Ref.	P [kW]	[m³/h]	☐	EAN
90-062	2	197	0/8	5907558447491
90-063	3	280	0/1	5907558447507
90-064	5	588	0/1	5907558447514

**JEDEN** akumulator **ONE** battery **ОДНА** аккумуляторная батарея  
**WIELE** możliwości **MANY** possibilities **МНОЖЕСТВО** возможностей



**ENERGY+**  
*system*

**NEO** **GRAPHITE**  
TOOLS

Jeden typ nowoczesnego akumulatora dla produktów marek GRAPHITE oraz NEO Tools, oznaczonych symbolem Energy+ System.

One type of modern battery for products of the brands GRAPHITE and NEO Tools, marked with the Energy+ System symbol.

Один тип современных аккумуляторных батарей для продуктов Energy+ System под марками GRAPHITE и NEO Tools.



## Młot udarowy / Hammer drill / Перфоратор

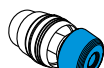

SDS-plus



3 FUNKCJE  
3 FUNCTIONS



ANTYWIBRACYJNA  
REKOJEŚĆ  
ANTI-VIBRATION  
HANDLE



REGULOWANA  
REKOJEŚĆ  
ADJUSTABLE  
HANDLE



1500W



230V ~50Hz



750 min<sup>-1</sup>



4,5 J



3200 min<sup>-1</sup>



4 m



Ref.	L-W-H [mm]	⊞ [kg]	⊞	EAN
58G862	425-145-340	9,4	0/2	5902062588623

## Wiertnica diamentowa / Core Drill / Установка алмазного бурения



PODŁĄCZENIE WODY  
WATER INLET  
ВОЗМОЖНОСТЬ ВОДЯНОГО  
ОХЛАЖДЕНИЯ



STATYW  
STAND  
ШТАТИВ



ZABEZPIECZENIE RÓŻNICOWO-PRĄDOWE  
PRCO SWITCH  
ЗАЩИТА ОТ ОСТАТОЧНОГО ТОКА



WSPORNIK BARKOWY  
SHOULDER REST  
ПЛЕЧЕВОЙ УПОР



2200W



230V ~50Hz



MAX 180 mm



1 1/4"



0-2000 min<sup>-1</sup>



3 m

Ref.	L-W-H [mm]	⊞ [kg]	⊞	EAN
58G540	340-725-220	14,5	0/1	5902062085580

## Wiertarko-mieszarka / Drill mixer / Дрель-миксер

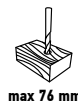
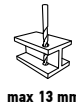

Ref.	L-W-H [mm]	Ⓛ [kg]	📦	EAN
58G605	310-210-300	5,2	0/4	5902062586056

## Wiertarko-wkrętarka sieciowa / Electric screwdriver / Дрель-шурупверт электрическая



SZYBKOWYMIENNY UCHWYT  
QUICK CHUCK  
БЫСТРОСМЕННЫЙ ПАТРОН



GNIAZDO NA WITY  
HEX SOCKET  
ПАТРОН ДЛЯ БИТ



PRECYZYJNA KONTROLA PRĘDKOŚCI  
PRECISE SPEED CONTROL  
ТОЧНЫЙ КОНТРОЛЬ СКОРОСТИ



DWIE FUNKCJE  
TWO FUNCTIONS  
ДВУХРЕЖИМНЫЙ



Ref.	L-W-H [mm]	Ⓛ [kg]	📦	EAN
58G793	350-295-118	3,1	0/4	5902062087805

**GRAPHITE**  
POWER IN YOUR HANDS

**3**  
YEARS  
WARRANTY

3 lata gwarancji na WSZYSTKIE elektrnarzędzia, urządzenia, akumulatory i ładowarki marki GRAPHITE. Regulamin dostępny na [graphite.pl](http://graphite.pl)  
3-year warranty on all power tools, devices, batteries and chargers. Terms and conditions are available on [en.graphite.pl](http://en.graphite.pl)  
Гарантия распространяется на все электроинструменты GRAPHITE, включая батареи. Подробная информация доступна на сайте [ru.graphite.pl](http://ru.graphite.pl)

## Szlifierka kąтова / Angle grinder / Шлифмашина угловая



**BLOKADA  
WŁĄCZNIKA  
SWITCH  
LOCK**



**DWUSTRONNY  
MONTAŻ  
UCHWYTU  
TWO-POSITION  
HANDLE**



230V -50Hz



1100W



125 mm



11000 min<sup>-1</sup>



M14

Ref.	L-W-H [mm]	Ⓜ [kg]	📦	EAN
59G110	325-125-110	2,9	0/6	5902062022356

## Szlifierka kąтова / Angle grinder / Шлифмашина угловая



**ŁAGODNY  
ROZRUCH  
SOFT  
START**



**REGULOWANA  
RĘKOJEŚĆ  
ADJUSTABLE  
HANDLE**

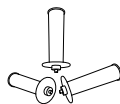

**TRÓJSTRONNY  
MONTAŻ  
UCHWYTU  
THREE-POSITION  
HANDLE**



**ŁATWY DOSTĘP  
DO SZCZOTEK**



230V -50Hz



2350W



230 mm



6500 min<sup>-1</sup>



M14

Ref.	L-W-H [mm]	Ⓜ [kg]	📦	EAN
59G207	525-175-125	6,0	0/2	5902062034656

## Bruzdownica / Wall Chaser / Штроболез



ERGONOMICZNY  
WŁĄCZNIK  
ERGONOMIC  
SWITCH



SYSTEM  
ODSYSANIA  
PYŁU  
DUST  
EXTRACTION  
SYSTEM



KONTROLA  
GŁĘBOKOŚCI  
BRUZDY  
MILLING  
DEPTH  
ADJUSTMENT



REGULOWANA  
RĘKOJĘC  
ADJUSTABLE  
HANDLE



1320W



230V ~50Hz



9000 min<sup>-1</sup>



8-26 mm



125 mm



8-30 mm

## Bruzdownica / Wall Chaser / Штроболез



ERGONOMICZNY  
WŁĄCZNIK  
ERGONOMIC  
SWITCH



SYSTEM  
ODSYSANIA  
PYŁU  
DUST  
EXTRACTION  
SYSTEM



KONTROLA  
GŁĘBOKOŚCI  
BRUZDY  
MILLING  
DEPTH  
ADJUSTMENT



150 mm



9000 min<sup>-1</sup>



0-43 mm



30 mm

Ref.	L-W-H [mm]	☐ [kg]	📦	EAN
59G370	400-270-230	6,5	0/3	5902062593702

Ref.	L-W-H [mm]	☐ [kg]	📦	EAN
59G371	550-200-340	11.0	0/2	5902062503596

**GRAPHITE**  
POWER IN YOUR HANDS

**3**  
YEARS  
WARRANTY

3 lata gwarancji na WSZYSTKIE elektroniczne urządzenia, akumulatory i ładowarki marki GRAPHITE. Regulamin dostępny na [graphite.pl](http://graphite.pl)  
3-year warranty on all power tools, devices, batteries and chargers. Terms and conditions are available on [en.graphite.pl](http://en.graphite.pl)  
Гарантия распространяется на все электроинструменты GRAPHITE, включая батареи. Подробная информация доступна на сайте [ru.graphite.pl](http://ru.graphite.pl)

# Odkurzacz warsztatowy / Workshop vacuum cleaner / Пылесос промышленный



DO PRACY Z PYLEMI  
GIPSOWYM  
GYPSUM  
DUST SAFE



GNIAZDO  
PRZYŁĄCZENIOWE  
ELECTRICAL  
SOCKET



RURA  
TELESKOPOWA  
TELESCOPIC  
PIPE



DO PRACY  
NA SUCHO  
I MOKRO  
FOR DRY  
AND WET  
OPERATION



INOX 30L



1500W



230V ~50Hz



18 kPa



30 l



max 2000 W



4 m

Ref.	L-W-H [mm]	☑ [kg]	📦	EAN
59G607	355-355-610	10,0	0/1	5902062596079

## Opalarka / Hot air gun / Термофен



REGULACJA ZAKRESU TEMPERATURY  
TEMPERATURE ADJUSTMENT  
РЕГУЛИРОВКА ТЕМПЕРАТУРЫ



REGULACJA SIŁY NAWIEWU  
AIR FLOW ADJUSTMENT  
РЕГУЛИРОВАНИЕ СИЛЫ ВОЗДУШНОГО ПОТОКА



OGUMOWANY UCHWYT  
SOFT GRIP HANDLE  
РЕЗИНОВАЯ РУЧКА



2000W



230V ~50Hz



I: 50°C  
II: 50-550°C  
III: 50-550°C



I: 350 l/min  
II: 350 l/min  
III: 500 l/min



3 m

Ref.	L-W-H [mm]	☑ [kg]	📦	EAN
59G526	110-345-320	2,4	0/5	5902062086747

## Opalarka / Hot air gun / Термофен

**NEO**  
TOOLS



REGULACJA SIŁY NAWIEWU  
AIR FLOW ADJUSTMENT  
РЕГУЛИРОВАНИЕ СИЛЫ ВОЗДУШНОГО ПОТОКА



PRECYZYJNE STEROWANIE  
PRECISE CONTROL  
ТОЧНОЕ УПРАВЛЕНИЕ



CYFROWY WSKAŹNIK TEMPERATURY  
DIGITAL TEMPERATURE DISPLAY  
ЦИФРОВОЙ ПОКАЗАТЕЛЬ ТЕМПЕРАТУРЫ



OGUMOWANY UCHWYT  
SOFT GRIP HANDLE  
РЕЗИНОВАЯ РУЧКА



  
**2000W**

  
230 V - 50 Hz

  
300 - 500  
l/min

  
I: 50°C  
II: 70-600°C

  
6m

**3**  
YEARS  
WARRANTY

**10**  
YEARS  
SPARE PARTS  
AVAILABILITY

Ref.	P [W]	T [C]	[l/min]		EAN
04-710	2000	50-600	300-500	0/5	5907558470550

## Opalarka / Hot air gun / Термофен

  
**2000W**

  
**230V -50Hz**

  
I: 350°C  
II: 550°C

  
I: 300 l/min  
II: 500 l/min



PROSTY UCHWYT  
COMPACT HANDLE  
ЭРГОНОМИЧНАЯ РУЧКА



2 - STOPNIOWY PRZEŁĄCZNIK  
SWITCH SETTING I/ II  
НАСТРОЙКА ПЕРЕКЛЮЧАТЕЛЯ I/ II



WSPORNIK  
STAND  
ТРЕНОГА



PODKŁADKI  
PADS  
КОЛОДКИ

Ref.	L-W-H [mm]	 [kg]		EAN
59G523	380-90-155	1	0/10	5902062086730

**GRAPHITE**  
POWER IN YOUR HANDS

**3**  
YEARS  
WARRANTY

3 lata gwarancji na WSZYSTKIE elektroniczne urządzenia, akumulatory i ładowarki marki GRAPHITE. Regulamin dostępny na [graphite.pl](http://graphite.pl)  
3-year warranty on all power tools, devices, batteries and chargers. Terms and conditions are available on [en.graphite.pl](http://en.graphite.pl)  
Гарантия распространяется на все электронные инструменты GRAPHITE, включая батареи. Подробная информация доступна на сайте [ru.graphite.pl](http://ru.graphite.pl)

**Wiertarko-wkrętarka akumulatorowa z udarem**  
**Cordless drill with impact**  
**Ударная аккумуляторная дрель-шурупверт**

Ref. 58G020

**GRAPHITE**  
BRUSHLESS

**18V**  
**Li-ion**



Silnik bezszczotkowy  
Brushless motor  
Вентильный  
электродвигатель

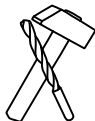

Wiercenie z udarem  
Impact drilling  
Сверление с ударом

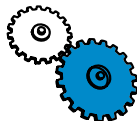

Dwa biegi mechaniczne  
Two mechanical gears  
Две механические  
скорости



Wysoki moment obrotowy  
High torque  
Высокий вращающийся  
момент

Udar  
Impact  
Удар  
I: 0-7500 min<sup>-1</sup>  
II: 0-25500 min<sup>-1</sup>

Zakres uchwytu  
Chuck range  
Рабочий диапазон патрона  
2-13 mm

Metalowy uchwyt  
jednotulejowy  
Metal single sleeve chuck  
Однотыльзовый  
металлический патрон

Regulacja prędkości  
obrotowej  
Rotational speed control  
Регулировка скорости  
вращения

Gumowana, ergonomiczna  
rękojeść  
Rubber coated, ergonomic  
handle  
Прорезиненная,  
эргономичная рукоятка

Oświetlenie LED  
LED illumination  
Подсветка LED

Zacpek do paska  
Belt hook  
Крепление на ремень

Dwa biegi  
Two gears  
Две скорости  
I: 0-5000 min<sup>-1</sup>  
II: 0-1700 min<sup>-1</sup>

Moment obrotowy  
Torque  
Крутящий момент  
38/58 Nm



Dane techniczne	Specifications	Технические условия	
napięcie akumulatora	battery voltage	напряжение на аккумуляторе	18V DC
zakres prędkości obrotowej	range of idle	диапазон частоты вращения	0-500 min <sup>-1</sup>
na biegu jałowym	rotational speed	на холостом ходу	0-1700 min <sup>-1</sup>
częstotliwość udaru na	impact speed	частота удара на холостом	0-7500 min <sup>-1</sup>
biegu jałowym	on idle	ходу	0-25500 min <sup>-1</sup>
zakres uchwytu	range of quick	рабочий диапазон	2-13 mm
szybkocomocującego	release chuck	быстрозажимного патрона	
zakres regulacji momentu	torque control	диапазон регулировки	1 - 16 + drilling
obrotowego	range	крутящего момента	+ impact drilling
max. moment obrotowy	max. torque	макс. крутящий момент	38 Nm
(wkręcanie miękkie)	(soft drive)	(«мягкое» ввинчивание)	
max. moment obrotowy	max. torque	макс. крутящий момент	58 Nm
(wkręcanie twarde)	(hard drive)	(«твердое» ввинчивание)	
waga	weight	вес	1.2 kg
EAN	EAN	EAN	5902062045959



WYDAJNOŚĆ / EFFICIENCY / ПРОИЗВОДИТЕЛЬНОСТЬ



**Młotowiertarka akumulatorowa**  
**Cordless rotary hammer drill**  
**Аккумуляторный перфоратор**

Ref. 58G009

**18V**  
**Li-ion**

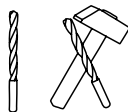

2-funkcje  
 Two functions  
 Двухрежимный

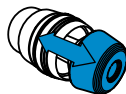

Uchwyt SDS+  
 SDS+ chuck  
 Патрон SDS+

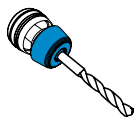

System mocowania „click”  
 “click” chuck system  
 Система крепления „click”



Oświetlenie  
 Lighting  
 Освещение

Uchwyt  
 Chuck  
 Рабочий патрон  
**SDS-Plus click**

Oświetlenie LED  
 LED illumination  
 Подсветка LED

Udar  
 Impact  
 Удар  
**0-5000 min<sup>-1</sup>**

Regulacja prędkości  
 obrotowej  
 Rotational speed control  
 Регулировка скорости  
 вращения

Gumowana, ergonomiczna  
 rękojeść  
 Rubber coated, ergonomic  
 handle  
 Прорезиненная,  
 эргономичная рукоятка

Energia uderu  
 Impact energy  
 Энергия удара  
**0.8 J**

Obroty  
 Rotational speed  
 Частота вращения  
**0-900 min<sup>-1</sup>**

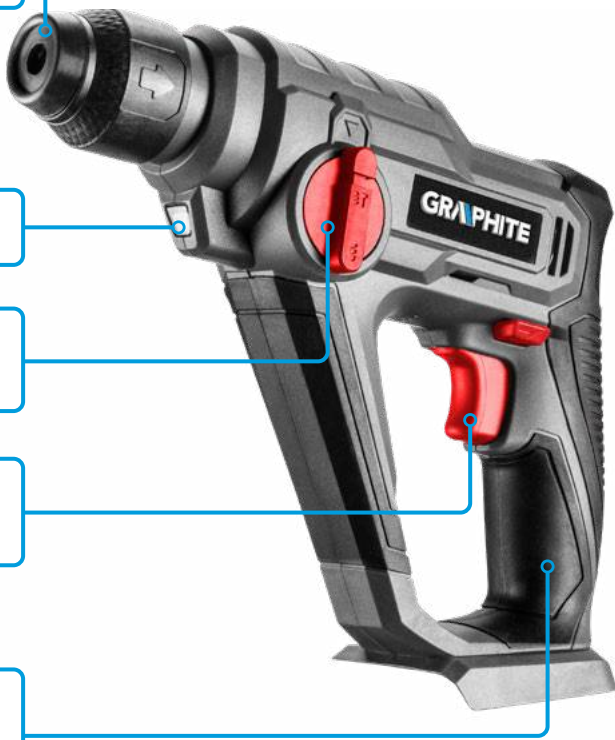

Dane techniczne	Specifications	Технические условия	
napięcie akumulatora	battery voltage	напряжение на аккумуляторе	18V DC
prędkość obrotowa	rotational speed	частота вращения	0-900 min <sup>-1</sup>
częstotliwość udaru	impact rate	частота удара	0-5000 min <sup>-1</sup>
energia uderu	impact energy	энергия удара	0,8 J
uchwyt narzędziowy	tool chuck	патрон	SDS-Plus
klasa ochronności	protection class	класс защиты	III
waga	weight	вес	1.21 kg
EAN	EAN	EAN	5902062035370

WYDAJNOŚĆ / EFFICIENCY / ПРОИЗВОДИТЕЛЬНОСТЬ

2.0Ah → 32x 6x40mm B20

4.0Ah → 63x 6x40mm B20

**GRAPHITE**  
**POWER IN YOUR HANDS**



3 lata gwarancji na WSZYSTKIE elektronarzędzia, urządzenia, akumulatory i ładowarki marki GRAPHITE. Regulamin dostępny na [graphite.pl](http://graphite.pl)  
 3-year warranty on all power tools, devices, batteries and chargers. Terms and conditions are available on [en.graphite.pl](http://en.graphite.pl)  
 Гарантия распространяется на весь электроинструмент GRAPHITE, включая батареи. Подробная информация доступна на сайте [ru.graphite.pl](http://ru.graphite.pl)



Szlifierka kątowa akumulatorowa  
Cordless angle grinder  
Акумуляторная угловая шлифовальная машина

Ref. 58G026

**GRAPHITE**  
BRUSHLESS

**18V**  
**Li-ion**



Silnik bezszczotkowy  
Brushless motor  
Вентильный электродвигатель



Wąska obudowa  
Narrow body  
Узкий корпус

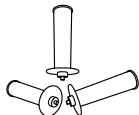

Dwustronny montaż uchwytu  
Two-position handle  
Двухпозиционная фиксация рукоятки



Blokada wrzeciona  
Spindle lock  
Блокировка шпинделя

Bezpieczny włącznik  
Safe switch  
Безопасная кнопка включения

Obroty  
Rotational speed  
Частота вращения  
**10000 min<sup>-1</sup>**

Beznarzędziowa regulacja osłony  
Tool free adjustment of the disc guard  
Безинструментальная регулировка защитного кожуха

Średnica tarczy  
Disc diameter  
Диаметр диска  
**125 mm**

Wąski gumowany, ergonomiczny uchwyt  
Rubber coated, ergonomic handle  
Прорезиненная, эргономичная рукоятка

Dane techniczne	Specifications	Технические условия	
napięcie akumulatora	battery voltage	напряжение на аккумуляторе	18V DC
prędkość obrotowa	rotational speed	частота вращения	10000 min <sup>-1</sup>
max. średnica tarczy	maximum wheel diameter	макс. диаметр круга	125 mm
wewnętrzna średnica tarczy	inner wheel diameter	диаметр посадочного отверстия круга	22,2 mm
gwint wrzeciona	spindle thread	резьба шпинделя	M14
klasa ochronności	protection class	класс защиты	III
waga	weight	вес	1.7 kg
EAN	EAN	EAN	5902062059772



## Akumulator systemu GRAPHITE ENERGY+

### GRAPHITE ENERGY+ battery

### Аккумуляторная батарея системы

### GRAPHITE ENERGY+

Ref. 58G001

Ref. 58G004

# 18V

## Li-ion

System kontroli przepływu prądu  
Current flow control system  
Система контроля тока

Wskaźnik stanu naładowania  
Battery level indicator  
Индикатор уровня заряда

Elektroniczny system kontroli temperatury  
Electronic system for temperature control  
Электронная система контроля температуры

Brak efektu pamięci  
No memory effect  
Без эффекта памяти

Dane techniczne	Specifications	Технические условия	58G001	58G004
napięcie akumulatora	battery voltage	напряжение на аккумуляторе	18V DC	18V DC
typ akumulatora	battery type	тип аккумулятора	Li-ion	Li-ion
pojemność akumulatora	battery capacity	емкость аккумулятора	2Ah	4Ah
zakres temperatury otoczenia	ambient temperature range	диапазон температур окружающей среды	4°C – 40°C	4°C – 40°C
waga	weight	вес	0.4 kg	0.65 kg
EAN	EAN	EAN	5902062035295	5902062035325

## Ładownica do akumulatorów GRAPHITE ENERGY+

### GRAPHITE ENERGY+ battery charger

### Зарядное устройство системы GRAPHITE ENERGY+

Ref. 58G002

# 2.3A

Do akumulatorów  
For batteries  
Для аккумуляторных батарей  
Energy + 18V

Elektroniczny system kontroli ładowania  
Electronic system for charging control  
Электронная система контроля зарядки

Prąd ładowania  
Charging current  
Ток заряда  
2.3A

Dioda sygnalizacyjna  
Indicator diode  
Сигнализационный светодиод

Kompaktowy rozmiar  
Compact size  
Компактный размер

Dane techniczne	Specifications	Технические условия	
napięcie zasilania	supply voltage	напряжение питания	230V AC
częstotliwość zasilania	power supply frequency	частота тока питающей сети	50 Hz
napięcie ładowania	charging voltage	напряжение заряда	22 V DC
max. prąd ładowania	max. charging current	макс. ток заряда	2.3A
czas ładowania	charging time	время зарядки	1-3h
zakres temperatury otoczenia	ambient temperature range	диапазон температур окружающей среды	4°C – 40°C
klasa ochronności	protection class	класс защиты	II
waga	weight	вес	0.3 kg
EAN	EAN	EAN	5902062035301

# GRAPHITE

POWER IN YOUR HANDS

**3**  
YEARS  
WARRANTY

3 lata gwarancji na WSZYSTKIE elektronarzędzia, urządzenia, akumulatory i ładowarki marki GRAPHITE. Regulamin dostępny na [graphite.pl](http://graphite.pl)  
3-year warranty on all power tools, devices, batteries and chargers. Terms and conditions are available on [en.graphite.pl](http://en.graphite.pl)  
Гарантия распространяется на весь электроинструмент GRAPHITE, включая батареи. Подробная информация доступна на сайте [ru.graphite.pl](http://ru.graphite.pl)

**Zestaw: wiertarko-wkrętarka akumulatorowa, torba + latarka**  
**Set: cordless drill, cordless flashlight, power tool bag**  
**Набор: дрель-шурупверт аккумуляторная, сумка + фонарь**

Ref. 58G016

# 18V

## Li-ion

Zestaw produktów – gotowy do użycia zestaw z poręczną torbą do przechowywania urządzeń i akcesoriów.

W skład zestawu wchodzi: wiertarko-wkrętarka, latarka, akumulator 2.0Ah, ładowarka, oraz torba.

Całość zapakowana w dedykowane opakowanie.

Set of products – ready to use with convenient bag to store devices and accessories.

The set includes: drill, flashlight, 2.0 Ah battery, charger and bag. All delivered in dedicated package.

Набор продуктов – готовый для эксплуатации набор с удобной сумкой для хранения электроинструмента и принадлежностей к нему.

В набор входят: дрель-шурупверт, фонарь, аккумуляторная батарея 2.0 Ач, зарядное устройство и сумка.

Все упаковано в специальную упаковку.



58G000

58G007



58G015



58G001



58G002

Dane techniczne	Specifications	Технические условия	
waga	weight	вес	2 kg
EAN	EAN	EAN	5902062038357

# Wiertła do betonu / Concrete drills / Сверла по бетону

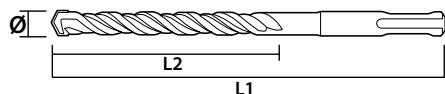

for **SDS<sup>plus</sup>**



Ref.	ø [mm]	L1	L2		EAN
57H400	4	110	50	50/300	5902062574008
57H404	5	160	100	50/200	5902062574046
57H406	6	110	50	50/300	5902062574060
57H408	6	160	100	50/200	5902062574084
57H410	6	210	150	50/200	5902062574107
57H411	6	260	200	50/200	5902062574121
57H412	7	260	200	50/200	5902062996879
57H414	8	110	50	10/200	5902062574145
57H416	8	160	100	50/200	5902062574169
57H418	8	210	150	50/200	5902062574183
57H419	9	260	200	50/200	5902062996886
57H420	8	260	200	50/200	5902062574206
57H424	10	160	100	50/100	5902062574244
57H426	10	210	150	0/200	5902062574268
57H428	10	260	200	50/200	5902062574282
57H430	10	350	290	25/150	5902062574305
57H432	10	400	340	25/100	5902062574329
57H434	10	600	540	0/100	5902062574343
57H438	12	160	100	50/200	5902062574381
57H440	12	210	150	50/200	5902062574404
57H442	12	260	200	40/160	5902062574428
57H444	12	310	250	25/150	5902062574442

Ref.	ø [mm]	L1	L2		EAN
57H446	12	400	340	25/100	5902062574466
57H448	12	450	390	25/100	5902062574480
57H450	12	600	540	0/60	5902062574503
57H454	14	210	150	25/150	5902062574541
57H456	14	260	200	25/100	5902062574565
57H458	14	310	250	1/100	5902062574589
57H460	14	350	290	25/100	5902062574602
57H462	14	400	340	20/80	5902062574626
57H464	14	450	390	15/60	5902062574640
57H466	14	600	540	0/60	5902062574664
57H470	16	210	150	25/100	5902062574701
57H472	16	260	200	25/100	5902062574725
57H474	16	310	250	20/80	5902062574749
57H476	16	400	340	15/60	5902062574763
57H478	16	600	540	0/45	5902062574787
57H480	18	260	200	1/80	5902062574800
57H482	18	310	250	0/50	5902062574824
57H484	18	400	340	15/60	5902062574848
57H486	18	600	540	0/40	5902062574862
57H488	20	600	540	0/25	5902062574886
57H490	20	800	740	0/20	5902062574909
57H492	24	600	540	0/20	5902062574923
57H494	24	800	740	0/12	5902062574947



for **SDS<sup>plus</sup>**



for **SDS<sup>plus</sup>**

Ref.	ø [mm]	L [mm]		EAN
57H570	6, 8, 10	110	50/100	5902062027443

Ref.	ø [mm]		EAN
57H572	5, 6, 8, 10, 12	25/200	5902062027450

**GRAPHITE**  
POWER IN YOUR HANDS



3 lata gwarancji na WSZYSTKIE elektronarzędzia, urządzenia, akumulatory i ładowarki marki GRAPHITE. Regulamin dostępny na [graphite.pl](http://graphite.pl)  
3-year warranty on all power tools, devices, batteries and chargers. Terms and conditions are available on [en.graphite.pl](http://en.graphite.pl)  
Гарантия распространяется на все электроинструменты GRAPHITE, включая батареи. Подробная информация доступна на сайте [graphite.ru](http://graphite.ru)

## Szpicak / Point chisel / Долото-пика

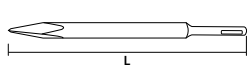

57H553



57H556



Ref.	ø [mm]	L[mm]	Type		EAN
57H553	14	250	SDS-plus	15/60	5902062078414
57H556	14	250	SDS-plus	15/60	5902062575562

## Dłuto / Chisel / Долото

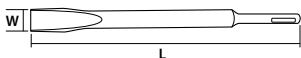

Ref.	ø [mm]	L[mm]	W[mm]	Type		EAN
57H554	14	250	40	SDS-plus	15/60	5902062078421
57H555	14	250	20	SDS-plus	15/60	5902062078438
57H557	14	250	20	SDS-plus	15/60	5902062575579
57H558	14	250	40	SDS-plus	15/60	5902062575586
57H559	17	350	50	SDS-plus	15/30	5902062575593

## Dłuto typ „U” / Chisel / Долото

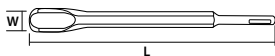

Ref.	ø [mm]	L[mm]	W[mm]	Type		EAN
57H560	14	250	22	SDS-plus	15/60	5902062575609

## Otwornica / Compass saw / Ножовка

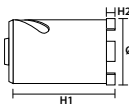

BETON CONCRETE



Ref.	ø1 [mm]	H1 [mm]	H2 [mm]		EAN
57H875	62	75	8	5/10	5902062578754
57H876	68	75	8	5/10	5902062578761
57H877	72	75	8	5/10	5902062578778
57H878	82	75	8	5/10	5902062578785

## Akcesoria do otwornic / Accessories for hole cutters / Принадлежности для корончатых сверл



57H879



57H880



57H881

Ref.	Info		EAN
57H879	SDS-plus	0/50	5902062578792
57H880	HEX	0/50	5902062578808
57H881	10 x 200 mm	0/50	5902062578815

## Tarcza diamentowa / Diamond disc / Алмазные круги

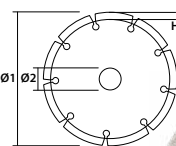

MPA ENT3236

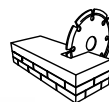

SPAWANE LASEROWO LASER WELDED



Ref.	ø1 [mm]	ø2 [mm]	H [mm]	W [mm]		EAN
57H606	125	22.2	8.0	2.2	50/100	5902062576064
57H610	230	22.2	8.0	2.5	0/25	5902062576101

# OFERTA SZYTA NA MIARĘ TAILORED-MADE OFFER ОФЕРТА ПОД ЗАКАЗ

## **Pakiet podstawowy NEO**

*Narzędzia ręczne i akcesoria*

## **NEO Basic Package**

*Hand tools and accessories*

## **Базовый пакет NEO**

*Ручные инструменты и принадлежности*



## **Pakiet premium NEO**

*Zestawy narzędzi ręcznych i elektronarzędzi*

## **NEO premium package**

*Hand and power tool sets*

## **Премиальный пакет NEO**

*Наборы ручных и электроинструментов*



Prezentowane pakiety zostały starannie wyselekcjonowane, aby ułatwić wybór potrzebnych narzędzi specjalistom.

The presented packages have been carefully selected to make it easier for specialists to choose the tools they need.

Представленные пакеты были тщательно отобраны, чтобы облегчить профессионалам выбор необходимых инструментов.

### **Pakiet rozszerzony NEO**

*Narzędzia ręczne, zestawy i akcesoria*

### **NEO Extended Package**

*Hand tools, sets and accessories*

### **Расширенный пакет NEO**

*Ручные инструменты, наборы и принадлежности*

### **Pakiet profesjonalny Graphite**

*Elektronarzędzia i akcesoria*

### **Graphite professional package**

*Power tools and accessories*

### **Профессиональный пакет Graphite**

*Электроинструменты и принадлежности*



**NEO**  
TOOLS

**GRAPHITE**

