

MOTO

2021

NEO
TOOLS

GRAPHITE

*Polecam
P. Szafaricki*

PROFESJONALNE NARZĘDZIA MOTORYZACYJNE

PROFESSIONAL AUTOMOTIVE TOOLS

ПРОФЕССИОНАЛЬНЫЙ ИНСТРУМЕНТ ДЛЯ АВТОСЕРВИСА





NARZĘDZIA **MECHANICZNE**
MECHANICAL TOOLS
МЕХАНИЧЕСКИЕ ИНСТРУМЕНТЫ



9-53

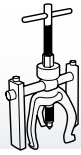

NARZĘDZIA **WARSZTATOWE**
WORKSHOP TOOLS
ИНСТРУМЕНТЫ ДЛЯ МАСТЕРСКОЙ



54-91



WYPOSAŻENIE **WARSZTATU**
WORKSHOP EQUIPMENT
ОСНАЩЕНИЕ МАСТЕРСКОЙ

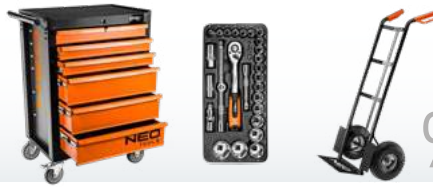

92-108



PNEUMATYKA
PNEUMATICS
ПНЕВМАТИКА



109-117



ELEKTRONARZĘDZIA I AKCESORIA
POWER TOOLS AND ACCESSORIES
ЭЛЕКТРОИНСТРУМЕНТЫ И АКСЕССУАРЫ



118-133

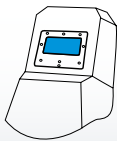

SPAWANIE
WELDING
СВАРКА



134

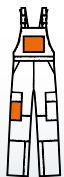

BHP
OHS
СИЗ



135-149

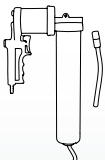

PRESSOL



150-154

NEO

TOOLS

25
years
GUARANTEE



NEO to...

- wysokiej klasy narzędzia dla wymagających użytkowników
- najnowsze technologie i materiały wykorzystywane w produktach
- 25 lat gwarancji* jakości i niezawodności

NEO is...

- top class tools for demanding users
- state-of-the-art technologies and materials used in the products
- excellent quality and reliability confirmed by 25 years warranty*

NEO это...

- инструмент высочайшего класса для требовательных пользователей
- продукты изготовлены с использованием новейших технологий и материалов
- 25 лет гарантии* качества и надежности, подтвержденной независимыми экспертами



Zapraszamy na kanały marki NEO w mediach społecznościowych

Come and browse NEO social media channels

Приглашаем на каналы марки NEO в социальных сетях



@NEOTOOLS



Informacje o nowościach produktowych, wydarzeniach, konkursy, porady oraz video

Information about novelties, events, competitions, tips and videos

Информации о новых продуктах, событиях, конкурсы, советы и видео



@NEOTOOLSOFFICIAL



VIDEO produktowe, porównania i testy produktów w wielu wersjach językowych

Product related VIDEOS, product comparisons and tests in multiple language versions

ВИДЕО о продуктах, сравнение и тесты продуктов в различных языковых версиях



NEOmov



*25 lat gwarancji oraz certyfikat TÜV M+T (Monitoring - Testing) produktów wybrane produkty NEO - szczegóły na stronie neo-tools.com
*Selected NEO products feature a 25-year warranty and a TÜV M+T Monitoring - Testing certificate - you can find details at neo-tools.com
*Некоторые товары NEO имеют 25-летнюю гарантию и сертификат TÜV M+T (Monitoring - Testing) - подробности информации доступны на сайте neo-tools.com



JAKOŚĆ

Najwyższa jakość materiałów i najnowocześniejsze rozwiązania technologiczne to kluczowe założenia standardów jakości NEO. Narzędzia NEO to ergonomiczne, precyzyjnie wykonane narzędzia stworzone do pracy w najcięższych warunkach. Produkty NEO testowane są zarówno w specjalistycznych laboratoriach jak i w miejscach pracy profesjonalistów.

QUALITY

High quality of materials and well proven technical solutions are the key foundations of the NEO quality standards. High quality and precision of workmanship make the NEO tools fit for use in the harshest conditions. NEO products are tested in specialised laboratories as well as in professionals' workplaces.

КАЧЕСТВО

Высокое качество материалов и проверенные технические решения являются ключевыми принципами стандартов качества NEO. Благодаря высокому качеству и точности исполнения инструменты NEO отлично проявляют себя в сложнейших рабочих условиях. Продукты NEO тестируются как в специализированных лабораториях, так и на местах работы профессионалов.

Laboratorium NEO Tools

Narzędzia NEO poddawane są specjalistycznym i rygorystycznym testom wytrzymałościowym. Badania jakościowe oparte są o normy europejskie. System zarządzania jakością w Dziale Technicznym posiada certyfikat zgodności z jedną z najważniejszych norm dotyczących kontroli jakości ISO 9001:2015

NEO Tools laboratory

NEO tools undergo specialised and rigorous strength testing. Quality testing is based on European standards. The quality management system of the Technical Department is certified for compliance with one of the most important standards in the quality control field: ISO 9001:2015.

Лаборатория NEO Tools

Инструменты NEO подвергаются строгому специализированному тестированию на прочность. Проверка качества выполняется согласно европейским нормам. Система управления качеством в техническом отделе имеет сертификат соответствия одной из важнейших норм, касающихся контроля качества ISO 9001:2015



NEO
TOOLS





W procesie produkcji wykorzystywane są starannie wyselekcjonowane materiały, a jakość narzędzi jest stale weryfikowana w trakcie rygorystycznych procedur kontrolnych. Produkty NEO spełniają najwyższe kryteria jakościowe, czego znakiem jest 25-letni okres ochrony gwarancyjnej na narzędzia mechaniczne NEO.

Manufacturing process uses carefully selected materials, and the tool quality is constantly verified with rigorous control procedures. NEO products meet the highest quality criteria, which is confirmed with 25 years warranty for NEO mechanical tools.

В процессе производства используются старательно отобранные материалы, а качество инструментов постоянно верифицируется в ходе строгих контрольных процедур. Продукты NEO отвечают наивысшим критериям качества, что подтверждает 25-летняя гарантия на механические инструменты NEO.

Narzędzia NEO cieszą się zaufaniem wymagających użytkowników oraz profesjonalistów, którzy poszukują rozwiązań na najwyższym poziomie. O niezawodności i uznaniu ze strony środowiska biznesowego świadczą liczne wyróżnienia. Najważniejszym z nich jest międzynarodowy certyfikat TÜV, który jest jednym z najbardziej rozpoznawalnych znaków jakości na świecie.

NEO tools earned trust of demanding users and professionals who search for solutions of the highest standards. Reliability and recognition in the business sector are confirmed with numerous prizes and distinctions. The most important of all is the international TÜV certificate, one of the most recognised quality marks in the world.

Инструменты NEO пользуются доверием требовательных пользователей и профессионалов, ищущих решений на наивысшем уровне. О надежности и признании со стороны профессионального сообщества свидетельствуют многочисленные знаки отличия. Важнейший из них - международный сертификат TÜV, являющийся одним из наиболее узнаваемых знаков качества в мире.



NEO GARAGE

TESTOWANIE NARZĘDZI

Narzędzia mechaniczne i warsztatowe marki NEO Tools są testowane nie tylko w naszych laboratoriach, ale przede wszystkim w realnych warunkach pracy. Nasze narzędzia zanim wejdą na rynek używane są w profesjonalnym warsztacie mechanicznym NEO Garage.

Mechanicy NEO Garage, wykonując codzienne prace warsztatowe takie jak:

- przeglądy okresowe
 - naprawy silników, zawieszę, układów hamulcowych i kierowniczych, itd.
 - renowacje samochodów zabytkowych
- dostarczają informacji zwrotnych pozwalających ulepszać nasze narzędzia.

Dzięki temu możemy zaoferować Państwu najwyższej jakości produkty przeznaczone do pracy w branży motoryzacyjnej.

Zachęcamy do dokładnej analizy katalogu i zaopatrzenia swoich firm w narzędzia mechaniczne i warsztatowe marki NEO Tools.

TOOL TESTING

Mechanical and workshop NEO Tools are tested not only in our laboratories, but above all in real working conditions. Before introduction to the market, our tools are used in professional mechanical workshop NEO Garage.

Mechanical engineers of NEO Garage perform everyday workshop tasks, such as:

- periodic inspections
- repairs of engines, suspensions, braking and steering systems, etc.
- renovations of antique vehicles

and they can deliver feedback so we can improve our tools.

This allows us to offer products of the highest quality designed for automotive field.

Please see our catalogue in detail and supply your company with NEO Tools for mechanical and workshop use.

ТЕСТИРОВАНИЕ ИНСТРУМЕНТА

Механические инструменты, а также инструменты для СТО марки NEO Tools проходят испытания не только в наших лабораториях, но, прежде всего, в реальных условиях работы. Наши инструменты, прежде чем выйти на рынок, используются в профессиональной механической СТО NEO Garage.

Механики NEO Garage, выполняя ежедневные работы в СТО, такие как:

- регламентные технические осмотры
- ремонт двигателей, подвесок, тормозных и рулевых систем и т.д.
- восстановление и ремонт исторических автомобилей

обеспечивают обратную связь, позволяющую улучшить наши инструменты.

Благодаря этому мы можем предложить вам продукцию высочайшего качества, предназначенную для работы в автомобильной промышленности.

Мы рекомендуем вам тщательно проанализировать каталог и обеспечить свои компании механическими инструментами, а также инструментами для СТО марки NEO Tools.

Grzechotka

Ratchet handle / Ratsche / Трещотка / Держак з трітчаткою / Racsins kulcs / Miner de hurluitoare / Řehtačka / Račnja prepinacia / Raglja / Terkšle / Reversa atslega / Pärkratta pide / Трещоточка / Račva za nasadni ključ / Racva za gedoru / Κατσάβι / Llave de carraca / Cricchetto / Catraca de furar / Clé à cliquet / Ratel



Ref.	Info	L[mm]	⊖	EAN
08-540	1/4"	155	5/50	5907558435719
08-543	3/8"	200	5/25	5907558435726
08-546	1/2"	250	5/20	5907558435733



Ref.	Info	L[mm]	⊖	EAN
08-530	1/4"	155	10/50	5907558435689
08-533	3/8"	200	5/25	5907558435696
08-536	1/2"	250	5/20	5907558435702



Ref.	Info	L[mm]	⊖	EAN
08-504	1/4"	150	10/50	5907558420708
08-508	3/8"	210	6/48	5907558420715
08-521	1/2"	265	5/25	5907558420722



Ref.	Info	L[mm]	⊖	EAN
08-514	1/4"	150	12/72	5907558406276
08-513	3/8"	200	12/48	5907558406269
08-511	1/2"	250	0/24	5907558406205



Ref.	Info	L[mm]	⊖	EAN
08-516	1/2"	255	6/24	5907558409291



Ref.	Info	L[mm]	⊖	EAN
08-523	1/4"	155	6/72	5907558432190
08-524	3/8"	200	6/48	5907558432206
08-525	1/2"	250	6/36	5907558432213



Ref.	Info	L[mm]	⊖	EAN
08-503	1/4"	145	10/50	5907558412819
08-507	3/8"	195	5/60	5907558412833
08-520	1/2"	255	5/25	5907558412840



Ref.	Info	L _{min} [mm]	L _{max} [mm]	⊖	EAN
08-502	1/4"	150	200	10/50	5907558412802
08-506	3/8"	215	315	12/48	5907558412826
08-515	1/2"	305	445	0/25	5907558408546



Ref.	Info	L[mm]	⊖	EAN
08-519	1/2"	285	0/24	5907558410167



Grzechotka

Ratchet handle / Ratsche / Трещотка / Держак з тріщоткою / Racsns kulcs / Míner de hurluitoare / Řehtačka / Račňa prepinacia / Raglja / Terksle / Reversa atslēga / Pörkratta pide / Трещоточка / Račva za nasadni ključ / Račva za gedaru / Κατανά / Llave de carraca / Cricchetto / Catraca de furar / Clé à cliquet / Ratel



Ref.	Info	L[mm]	⌘	EAN
08-355	3/4"	500	0/16	5907558404449



Ref.	Info	L[mm]	⌘	EAN
08-501	1/4"	105	10/100	5907558421185



Ref.	Info	L[mm]	⌘	EAN
08-512	1/4"	105	10/60	5907558403305

Nasadka sześciokątna

Hexagonal socket / Sechskanteinsatz / Голова сменная шестигранная / Nasadka szestigranna / Dugőkulcs 6-lapú / Cheie tubulara hexagonală / Šestihranný nástavec / Šesthranný nástavec / Šestkotni natični nastavek / Šešikampis antgals / Šeštūra pomaĩnãmã galva / Kuuskantpradrum / Шестъгълна наставка / Šesterokutna kapica / Šestugona nasadka / Καροβόκι εξαγωνα / Vaso para destornillador hexagonal / Bussola esagonale / Bocal hexagonal / Douille à 6 pans / Zeskant dop



Ref.	W[mm]	⌘	EAN
08-442	4	25/200	5907558423280
08-443	4.5	25/200	5907558423297
08-444	5	25/200	5907558423303
08-445	5.5	25/200	5907558423310
08-446	6	25/200	5907558423327
08-447	7	25/200	5907558423334

Ref.	W[mm]	⌘	EAN
08-448	8	25/200	5907558423341
08-449	9	25/200	5907558423358
08-450	10	25/200	5907558423365
08-451	11	15/150	5907558423372
08-452	12	15/150	5907558423389
08-453	13	15/150	5907558423396
08-454	14	15/150	5907558423402



Ref.	W[mm]	⌘	EAN
08-168	8	20/200	5907558422757
08-170	10	20/200	5907558422764
08-171	11	20/200	5907558422771
08-172	12	20/200	5907558422788
08-173	13	20/200	5907558422795
08-174	14	20/200	5907558422801
08-175	15	20/200	5907558422818

Ref.	W[mm]	⌘	EAN
08-176	16	20/200	5907558422825
08-177	17	20/200	5907558422832
08-178	18	20/200	5907558422849
08-179	19	20/200	5907558422856
08-180	20	20/200	5907558422863
08-181	21	20/200	5907558422870
08-182	22	20/200	5907558422887



Ref.	W[mm]	⌘	EAN
08-408	8	20/200	5907558423037
08-409	9	20/200	5907558423044
08-410	10	20/200	5907558423051
08-411	11	20/200	5907558423058
08-412	12	20/200	5907558423065
08-413	13	20/200	5907558423072
08-414	14	20/200	5907558423079
08-415	15	20/200	5907558423086
08-416	16	20/200	5907558423093
08-417	17	20/200	5907558423100
08-418	18	20/200	5907558423107
08-419	19	20/200	5907558423114

Ref.	W[mm]	⌘	EAN
08-420	20	20/200	5907558423121
08-421	21	20/200	5907558423128
08-422	22	20/200	5907558423135
08-423	23	20/200	5907558423142
08-424	24	20/200	5907558423149
08-425	25	10/100	5907558423204
08-426	26	10/100	5907558423211
08-427	27	10/100	5907558423218
08-428	28	10/100	5907558423225
08-429	29	10/100	5907558423232
08-430	30	10/100	5907558423239
08-431	31	10/100	5907558423246
08-432	32	10/100	5907558423253



Nasadka sześciokątna SUPERLOCK

Hexagonal socket / Sechskanteinsatz / Голова сменная шестигранная / Nasadka szestigranna / Dugőkulcs / Cheie tubulara hexagonală / Šestihranný nástavec / Šesthranný nástavec / Šestkotni natični nastavek / Šešikampis antgals / Šeštūra pomaĩnãmã galva / Kuuskantpradrum / Шестъгълна наставка / Šesterokutna kapica / Šestugona nasadka / Καροβόκι εξαγωνα / Vaso para destornillador hexagonal / Bussola SuperLock / Bocal hexagonal / Douille à 6 pans / Zeskant dop

Ref.	W[mm]	⌘	EAN
08-220	4	100/500	5907558403787
08-221	4.5	100/500	5907558403794
08-222	5	25/200	5907558403800
08-223	5.5	25/200	5907558403817
08-224	6	100/200	5907558403824
08-225	7	25/200	5907558403831
08-226	8	25/200	5907558403848
08-227	9	50/500	5907558403855
08-228	10	25/200	5907558403862
08-229	11	50/500	5907558403869
08-230	12	15/150	5907558403876
08-231	13	15/150	5907558403883
08-232	14	50/500	5907558403890

Nasadka sześciokątna SUPERLOCK

Hexagonal socket / Sechskanteinsatz / Головная сменная шестигранный / Nasadka szestiyranno / Dugčukuls, Superlock / Cheie tubulara hexagonală / Seshitrannyi nastavek / Seshitrannyi nastavek / Seshtokni natični nastavek / Šešiakoptis angolis / Šešitūra nomainiama galva / Kuuskantpadrun / Шестькольная наставка / Šesterokutna kapica / Šestougaona nasadka / Kapučkiņ ēģiyu / Vaso para destornillador hexagonal / Bussola SuperLock / Bocal hexagonal / Douille à 6 pans / Zeskant dop



Nasadka sześciokątna długa SUPERLOCK

Hexagonal socket / Sechskanteinsatz / Головная сменная шестигранный / Nasadka szestiyranno / Dugčukuls hosszú, Superlock / Cheie tubulara hexagonală / Seshitrannyi nastavek / Seshitrannyi nastavek / Seshtokni natični nastavek / Šešiakoptis angolis / Šešitūra nomainiama galva / Kuuskantpadrun / Шестькольная наставка / Šesterokutna kapica / Šestougaona nasadka / Kapučkiņ ēģiyu / Vaso para destornillador hexagonal / Bussola SuperLock / Bocal hexagonal / Douille à 6 pans / Zeskant dop



Ref.	W[mm]	♂	EAN	Ref.	W[mm]	♂	EAN
08-008	8	20/200	5907558403503	08-021	21	20/200	5907558403558
08-009	9	20/200	5907558403510	08-022	22	20/200	5907558402414
08-010	10	20/100	5907558402353	08-023	23	10/100	5907558412468
08-011	11	20/100	5907558403527	08-024	24	20/100	5907558402421
08-012	12	20/100	5907558402360	08-025	25	10/100	5907558412475
08-013	13	20/200	5907558402377	08-026	26	10/100	5907558403565
08-014	14	20/100	5907558402337	08-027	27	10/100	5907558402438
08-015	15	20/200	5907558402384	08-028	28	10/100	5907558403572
08-016	16	20/200	5907558403534	08-029	29	10/100	5907558403589
08-017	17	20/200	5907558402391	08-030	30	10/100	5907558402445
08-018	18	20/200	5907558403541	08-031	31	10/100	5907558403596
08-019	19	20/200	5907558402407	08-032	32	10/100	5907558402452
08-020	20	10/100	5907558412451	08-036	36	10/0	5907558403602

Ref.	W[mm]	♂	EAN	Ref.	W[mm]	♂	EAN
08-235	4	50/500	5907558412055	08-241	8	50/200	5907558412116
08-236	4.5	50/500	5907558412062	08-242	9	50/200	5907558412123
08-237	5	50/500	5907558412079	08-243	10	25/200	5907558412130
08-238	5.5	50/500	5907558412086	08-244	11	50/150	5907558412147
08-239	6	50/500	5907558412093	08-245	12	50/300	5907558412154
08-240	7	25/200	5907558412109	08-246	13	50/150	5907558412161
				08-247	14	50/150	5907558412178



Nasadka sześciokątna długa

Hexagonal socket / Sechskanteinsatz / Головная сменная шестигранный / Nasadka szestiyranno / Dugčukuls hosszú 6-lapú / Cheie tubulara hexagonală / Seshitrannyi nastavek / Seshitrannyi nastavek / Seshtokni natični nastavek / Šešiakoptis angolis / Šešitūra nomainiama galva / Kuuskantpadrun / Шестькольная наставка / Šesterokutna kapica / Šestougaona nasadka / Kapučkiņ ēģiyu / Vaso para destornillador hexagonal / Bussola esagonale / Bocal hexagonal / Douille à 6 pans / Zeskant dop



Ref.	W[mm]	♂	EAN	Ref.	W[mm]	♂	EAN
08-487	4	25/200	5907558423679	08-493	8	25/200	5907558423730
08-488	4.5	25/200	5907558423686	08-494	9	25/200	5907558423747
08-489	5	25/200	5907558423693	08-495	10	25/200	5907558423754
08-490	5.5	25/200	5907558423709	08-496	11	15/150	5907558423761
08-491	6	25/200	5907558423716	08-497	12	15/150	5907558423778
08-492	7	25/200	5907558423723	08-498	13	15/150	5907558423785
				08-499	14	15/150	5907558423792



Ref.	W[mm]	♂	EAN	Ref.	W[mm]	♂	EAN
08-184	8	20/200	5907558422894	08-191	16	20/200	5907558422962
08-185	10	20/200	5907558422900	08-192	17	20/200	5907558422979
08-186	11	20/200	5907558422917	08-193	18	20/200	5907558422986
08-187	12	20/200	5907558422924	08-194	19	20/200	5907558422993
08-188	13	20/200	5907558422931	08-195	20	20/100	5907558423006
08-189	14	20/200	5907558422948	08-196	21	20/100	5907558423013
08-190	15	20/200	5907558422955	08-197	22	20/100	5907558423020



Ref.	W[mm]	♂	EAN	Ref.	W[mm]	♂	EAN
08-458	8	20/200	5907558423419	08-471	21	20/100	5907558423564
08-459	9	20/200	5907558423426	08-472	22	20/100	5907558423571
08-460	10	20/200	5907558423433	08-473	23	20/100	5907558423578
08-461	11	20/200	5907558423440	08-474	24	20/100	5907558423585
08-462	12	20/200	5907558423457	08-475	25	10/50	5907558423592
08-463	13	20/200	5907558423464	08-476	26	10/50	5907558423599
08-464	14	20/200	5907558423471	08-477	27	10/50	5907558423606
08-465	15	20/200	5907558423488	08-478	28	10/50	5907558423613
08-466	16	20/200	5907558423495	08-479	29	10/50	5907558423620
08-467	17	20/200	5907558423501	08-480	30	10/50	5907558423627
08-468	18	20/200	5907558423518	08-481	31	10/50	5907558423634
08-469	19	20/200	5907558423525	08-482	32	10/50	5907558423641
08-470	20	20/100	5907558423532	08-486	36	4/40	5907558423662

Nasadka dwunastokątna

Bi-hexagonal socket / Zwólkanteinsatz / Головная сменная двенадцатигранный / Nasadka dwanadciyranno / Dugčukuls / Kakssteinsatzkatun / Cheie tubulară, priză în 12 pite / Dvanadžitrannyi nastavek / Dvanadžitrannyi nastavek / Dvanadžitokni nasadni ključ / Dvuylikantnis angolis / Divpadsmitūra nomainiama galva / Kakssteinsatzkatun / Dvanadesetkošņna nastava / Dvanaesterokutna kapica / Dvanastesougaona nasadka / Kapučkiņ divčukliču / Vaso destornillador de encjeje dodecagonal / Bussola Spine / Bocal de doze angulus / Douille à 12 pans / Twaalfkant dop



Ref.	W[mm]	♂	EAN	Ref.	W[mm]	♂	EAN
08-070	10	8/200	5907558405613	08-077	18	6/96	5907558406085
08-086	11	12/144	5907558410594	08-078	19	6/96	5907558405688
08-071	12	20/200	5907558405620	08-080	21	6/96	5907558405656
08-072	13	12/200	5907558405637	08-081	22	6/120	5907558405625
08-073	14	20/200	5907558408249	08-082	24	6/72	5907558405682
08-074	15	12/144	5907558405644	08-083	27	6/72	5907558405699
08-075	16	20/200	5907558406078	08-084	30	10/50	5907558405705
08-076	17	20/200	5907558405651	08-085	32	6/96	5907558405712



Ref.	W[mm]	♂	EAN	Ref.	W[mm]	♂	EAN
08-320	19	10/80	5907558406108	08-327	38	10/40	5907558406177
08-321	22	10/80	5907558406115	08-328	41	10/40	5907558406184
08-322	24	10/80	5907558406122	08-329	46	10/20	5907558406191
08-323	27	10/80	5907558406139	08-331	55	10/20	5907558406211
08-324	30	10/80	5907558406146	08-332	60	10/20	5907558406224
08-325	32	10/60	5907558406153	08-333	21	10/80	5907558410631
08-326	36	10/60	5907558406160	08-335	34	10/60	5907558410655

TECHNOLOGIA SUPERLOCK

SUPERLOCK TECHNOLOGY / ТЕХНОЛОГИЯ SUPER LOCK

Nasadki NEO wykonane w technologii SUPERLOCK:

- większy moment obrotowy
- optymalny rozkład sił
- ochrona kształtu głowki śruby przed zniszczeniem
- możliwość użycia nasadki do śrub już zniszczonych
- użycie nasadek zwiększa trwałość elementów mocujących

NEO sockets are manufactured in SUPERLOCK technology:

- greater torque
- optimal force distribution
- protection of bolt head against damage
- socket can be used on damaged bolts
- use of sockets improves durability of joining elements

Сменные головки NEO изготовлены по технологии SUPERLOCK:

- больше крутящий момент
- оптимальное распределение нагрузки
- защита головки болта от повреждения
- возможность использования сменной головки при работе с поврежденными болтами
- использование сменных головок повышает прочность крепежа



Nasadka dwunastokątna SPLINE

Вш-hexagonal socket / Zwölfkantensatz / Головка сменная двенадцатигранная / Насадка двенадцатигранная / Dugokulcs, Spline / Cheie tubulara, prize in 12 pite / Dvanáctihranný nástavec / Dvanáctihranný nástavec / Dvanajskotni nasadni ključ / Dvylükakampis antigalis / Divpasmitštra nomaĩndĩ galva / Kaksteiskantpadrun / Дванадесетъгълна наставка / Dvanaesterokutna kapica / Dvanaestougona nasadka / Карубка дванадцатого / Vaso destornillador de encaje dodecagonal / Bussola Spline / Bocal de doze ângulos / Douille à 12 pans / Twaalfkant dop

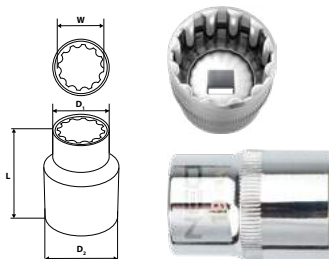

Jedna nasadka – wiele zastosowań!

One socket – many applications! / Одна головка – много вариантов применения!

SPLINE – UNIWEKSALNE

- Wszechstronność dzięki sferycznemu, 12-kątnemu kształtowi.
- Umożliwia pracę z większością śrub (Torx, SPLINE, 12-kątne, 6-kątne, metryczne, calowe, o kształcie kwadratu).

SPLINE – MULTIPURPOSE

- Versatile use thanks to spherical, 12 point shape
- Allows to work with most bolt heads (Torx, SPLINE, 12-point, hexagonal, metric, imperial, square).

SPLINE – УНИВЕРСАЛЬНЫЕ

- Универсальность благодаря сферической, 12-гранной форме.
- Дает возможность работать с большинством винтов (Torx, SPLINE, 12-гранными, 6-гранными, метрическими, дюймовыми, квадратной формы).



ROZMIAR RZE PAZEM (mm)	INCH		STAR	SPLINE	KWADRAT	
	6-kątna	12-kątna			MM	INCH
4,5	5/32"	5/32"	E5	M10	4	4,5
5	3/16"	3/16"	E6	M12	4	4,5
5,5	7/32"	7/32"	E7	M14	5	5
6	1/4"	1/4"	E8	M16	5	5
7	9/32"	9/32"	E10	M18	6	6
8	3/8"	3/8"	E12	M20	7	7,32"
9	11/32"	11/32"	E14	M22	8	5 1/16"
10	3/8"	3/8"	E16	M24	9	11/32"
11	7/16"	7/16"	E18		10	3/8"
12	15/32"	15/32"	E16			
13	1/2"	1/2"			11	7/16"
14	9/16"	9/16"	E18		12	15/32"
15	19/32"	19/32"	E18		13	1/2"
16	5/8"	5/8"	E20		14	7/16"
17	11/16"	11/16"	E22		15	
18	23/32"	23/32"	E22			
19	3/4"	3/4"	E24		16	5/8"
20	25/32"	25/32"	E24		17	11/16"
21	13/16"	13/16"	E26		18	23/32"
22	7/8"	7/8"	E28		19	3/4"
23					20	25/32"
24	15/16"	15/16"	E28		21	13/16"
25						
26					22	7/8"
27	1 1/16"	1 1/16"	E34		23	
28					24	15/16"
29	1 1/8"	1 1/8"				
30	1 9/16"	1 9/16"	E36		26	
32	1 1/4"	1 1/4"	E42		27	1 1/16"

Ref.	w(mm)	L(mm)	D1(mm)	D2(mm)	⌀	EAN
08-580	8	38	13,1	21,7	10/200	5907558408263
08-581	9	38	14,3	21,7	10/100	5907558408270
08-582	10	38	15,2	21,8	20/100	5907558408287
08-583	11	38	16,4	21,7	10/100	5907558408294
08-584	12	38	18	21,7	10/100	5907558408300
08-585	13	38	19	21,7	10/200	5907558408317
08-586	14	38	20	21,7	10/200	5907558408324
08-587	15	38	21,7	20,1	10/100	5907558408331
08-588	16	38	23	20,9	10/200	5907558408348
08-589	17	38	23,8	21,9	10/200	5907558408355
08-590	18	38	25,7	23,4	10/200	5907558408362
08-591	19	38	25,8	23,8	10/100	5907558408379
08-592	20	38	27,7	25,9	10/100	5907558408386
08-593	21	38	28,8	25,9	10/100	5907558408393
08-594	22	38	30	25,9	10/100	5907558408409
08-595	23	38	31	27,1	10/100	5907558412505
08-596	24	38	31,7	27,8	10/200	5907558408416
08-597	27	42	35,8	30,9	10/100	5907558408423
08-598	30	44	39,8	33,8	10/100	5907558408430
08-599	32	44	42	36	10/100	5907558408447
08-340	55	76	71	48	10/20	5907558412574
08-341	60	78	80	50	10/20	5907558412581



MM	10	12	13	15	17	19	22	24
INCH	3/8	15/32	1/2	19/32		3/4	7/8	15/16
STAR	E12	E16				E24		

Ref.	W(mm)	⌀	EAN
08-651	10, 12, 13, 15, 17, 19, 22, 24	0/30	5907558406290



MM	10	12	13	15	17	19	22	24
INCH	3/8	15/32	1/2	19/32		3/4	7/8	15/16
STAR	E12	E16				E24		

Ref.	W(mm)	⌀	EAN
08-650	10, 12, 13, 15, 17, 19, 22, 24	0/20	5907558406283

Końcówka Spline na nasadce

Spline bit / Spline-Endstück / Наконечник Spline / Наконечник „Spline” / Spline dugókulcs / Punct Spline / Nástavec Spline / Nástavec Spline / Nastavec Spline / Antgalis Spline / Uzgatis Spline / Spline-otsak / Накрайник Spline / Nastavak Spline / Настав Spline / Mítz Spline / Punta Spline / Inserto Spline sur bussola / Pontoiro Spline / Embout Spline / Spline eindstuck



Ref.	info	L[mm]	Ø	EAN
08-730	M5	55	12/144	5907558411911
08-731	M6	55	12/144	5907558411928
08-732	M8	55	12/144	5907558411935
08-733	M10	55	12/144	5907558411942
08-734	M12	55	12/160	5907558411959
08-735	M14	55	12/160	5907558411966
08-736	M16	55	12/144	5907558411973

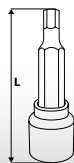

Ref.	info	L[mm]	Ø	EAN
08-740	M5	100	12/96	5907558411980
08-741	M6	100	12/96	5907558411997
08-742	M8	100	12/96	5907558412000
08-743	M10	100	12/96	5907558412017
08-744	M12	100	12/96	5907558412024
08-745	M14	100	12/96	5907558412031
08-746	M16	100	12/96	5907558412048

Końcówki sześciokątne na nasadce

Hexagonal bits on socket / Sechskanteinsätze auf Aufsatz / Головки шестигранные с насадкой / Наконечники шестигранные на насадці / Hatlapú dugókulcs / Trusa capete tubulare cu antrenor / Koncovky šestihřanné na nástavec / Šestihřanné koncovky na nástavec / Šestkotní nastavki za nasadni ključ / Šešiakmpiaí antgaliaí su laikikiú / Nomaināma galva ar sešstūra uzgaļiem / Kuuskantotsakud padrūmil / Шестоъгълни накрайници на наставката / Šesterokutni nastavci na kapici / Šestougołni nastavci za nasadke / Karóúaki me pítes, eřázawes / Vasos destornilladores hexagonales / Inserto esagonal con bussola / Pontoiros hexagonais no bico / Embouts à 6 pans sur ajutage / Zeskantí eindstukken op dop



Ref.	info	L[mm]	L1[mm]	Ø	EAN
08-770	H5	55	17	20/140	5907558409765
08-771	H6	55	17	12/144	5907558409772
08-772	H7	55	17	20/160	5907558409789
08-773	H8	55	17	12/144	5907558409796
08-774	H10	55	17	20/160	5907558409802
08-775	H12	55	17	20/160	5907558409819
08-776	H14	55	17	20/160	5907558409826
08-777	H17	55	17	20/160	5907558409833
08-778	H19	55	17	12/96	5907558409840

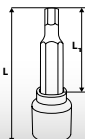

Ref.	info	L[mm]	L1[mm]	Ø	EAN
08-780	H5	100	62	12/96	5907558409857
08-781	H6	100	62	20/100	5907558409864
08-782	H7	100	62	12/96	5907558409871
08-783	H8	100	62	20/100	5907558409888
08-784	H10	100	62	20/100	5907558409895



H4, H5, H6, H7, H8, H10, H12, H14, H17



Ref.	L[mm]	Ø	EAN
08-705	55	0/12	5907558409253

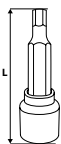

H4, H5, H6, H7, H8, H10, H12, H14, H17



Ref.	L[mm]	Ø	EAN
08-706	100	0/12	5907558409260

Końcówki Torx na nasadce

Torx bit on socket / Torx-Einsatz auf Aufsatz / Головка сменная с насадкой Torx / Наконечник «Torx» на насадку / Torx dugókulcs / Cap tubulara cu antrenor torx / Концовка Torx на наставка / Концовка Torx на наставка / Nastavek Torx za nasadni kluč / Torxincis antgalis su laikikliu / Nominātmā galva ar Torx uzgali / Torx-otsak padrunil / Накрайник Torx на наставката / Nastavak Torx na kapici / Nastavak Torx za nasadke / Καρβύκι με μύτη Torx / Vaso torx / Chiave Torx con bussola / Ponteiros Torx no bico / Embouts Torx sur ajutage / Trox einstukken op dop

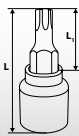

Ref.	info	L[mm]	L1[mm]	⌀	EAN
08-750	T20	55	17	12/144	5907558409604
08-751	T25	55	17	12/144	5907558409611
08-752	T27	55	17	12/144	5907558409628
08-753	T30	55	17	12/144	5907558409635
08-754	T40	55	17	20/160	5907558409642
08-755	T45	55	17	20/160	5907558409659
08-756	T50	55	17	12/144	5907558409666
08-757	T55	55	17	20/160	5907558409673
08-758	T60	55	17	12/144	5907558417388
08-759	T70	55	17	12/144	5907558417395

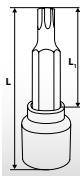

Ref.	info	L[mm]	L1[mm]	⌀	EAN
08-760	T20	100	62	12/96	5907558409680
08-761	T25	100	62	20/100	5907558409697
08-762	T27	100	62	20/100	5907558409703
08-763	T30	100	62	20/100	5907558409710
08-764	T40	100	62	12/96	5907558409727
08-765	T45	100	62	20/100	5907558409734
08-766	T50	100	62	20/100	5907558409741
08-767	T55	100	62	20/100	5907558409758

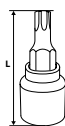

T20, T25, T27, T30, T40, T45, T50, T55, T60

Ref.	L[mm]	⌀	EAN
08-707	55	0/12	5907558409277

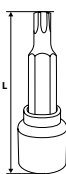

T20, T25, T27, T30, T40, T45, T50, T55, T60



Ref.	L[mm]	⌀	EAN
08-708	100	0/12	5907558409284

Końcówki wkrętakowe

Driver bits / Einsätze für Schraubendreher / Насадки / Наконечники викруток / Torx bit- és kulcskészlet / Set biti / Šroubovácové nástavce / Skrutkovacie nástavce / Nastavki za izvijače / Aktuelno antgalia / Skrivgräiärs uzgali / Krivikeerajatsakud / Накрайници за отвортка / Nastavci za odvijač / Nastavci za odvijač / Καταβιβόμετες / Puntas destornilladoras / Inserti lunghi e corti / Ponteiros Chave de fenda / Embouts de tournevis / Schraubendrehereinstukken

H7, H10, H11, H13, H14, H17, H19, H22, H24
 TS10, TS15, TS20, TS25, TS27, TS30, TS40, TS45, TS50
 T30, T40, T45, T50, T55, T60, T70, T80
 M9, M10, M12, M14, M16
 R7, R8, R9, R10
 H5



Ref.	⌀	EAN
08-710	0/3	5907558417104

Końcówki i nasadki torx

Torx bits and socket set / Torx-Aufsätze / Наконечники и головки торцевые Torx / Набор жпал та насадок «torx» / Torx bit- és kulcskészlet / Set canule "torx" si fixări / Bity a nástavce Torx / Súprava klúčov torx/bity, klúče, hlavice / Garnitura nastavkov z vpenjalom / Antgaliu Torx ir galvučių rinkinys / Torx atslėgu un mucipju komplekts / "Torx" atsikute ja padruite komplekts / Вножки и накрайниці / Set Nasadni klujeva I biceva / Set biceva I gedora / Συλλογή από μύτσες και καρυδιά / Puntas destornilladoras y vasos TORX / Inserti Torx, Tamper Torx e bussole Spline / Ponteiras e Bocais Torx / Embouts et douilles Torx / Torx eindstukken en doppen

E4, E5, E6, E7, E8, E10, E11, E12, E14, E16, E18, E20

T10, T15, T20, T25, T27, T30, T40, T45, T50, T55, T60

TT10, TT15, TT20, TT25, TT27, TT30, TT40, TT45, TT50, TT55



Ref.	🔩	EAN
08-711	0/12	5907558417111

Zestaw bitów Torx

Torx bit set / Bitsatz Torx / Набор насадок torx / Набор нанонечників «torx» / Torx bitkészlet / Set de bituri torx / Sada bitů Torx / Súprava bitov Torx / Set bitov Torx / Antgaliu kompleksas „Torx” / Torx uzgaliu komplekts / Padruināvēmete komplekts Torx / Комплект битовое torx / Set torx bitova / Komplet torx bitova / Set mύτσες torx / Juego de puntas torx / Inserti Torx, Spline, esagonali / Jogo de bites torx / Ensemble de bits Torx / Set van Torx bits

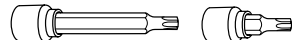

H6, H7, H8, H10, H12
T25, T30, T40, T45, T50, T60
M6, M8, M10, M12, M14

H5, H6, H7, H8, H10, H12, H14, H17, H19
T20, T25, T27, T30, T40, T45, T50, T55, T60, T70
M5, M6, M8, M10



T20, T25, T27, T30, T40, T45, T50, T60



Ref.	🔩	EAN
08-713	0/3	5907558420180

Klucze nasadowe TORX

TORX sockets / Steckschlüssel TORX / Головки сменные Torx / Ключи торцевеі «TORX» / Torx kulcskészlet / Chei tubulare TORX / Nástrčné klúče TORX / KLUČE nástrčné torxoné / Klučiči nasadni TORX / Torcinių galvučių kompleksas / Torx uzmaucātās galatslēgas / TORX padruinā / Комплекти инструменти мун TORX / Nasadni TORX klujevi / Nasadni klujevi TORX / Καρυδιά TORX / Llave de vaso TORX / Set di bussolle Torx / Chaves articuladas TORX / Cles a douille TORX / TORX dopseuleuts



E10, E11, E12, E14, E16, E18, E20, E22, E24

Ref.	🔩	EAN
08-649	0/15	5907558417074

Klucz dynamometryczny

Torque wrench / Drehmomentschlüssel / Ключ динамометрический / Ключ динамометричний / Nyomatékkulcs / Cheie dinamometrică / Динамометричкй кліч / Динамометричкй кліч / Dinamometrični kluč / Dinamometris raktas / Dinamometriska atslėga / Dinamometrične vdi / Динамометричен ключ / Dinamometrički kluč / Обртни клуč / Δυναμετρικό κλειδί / Llave dinamométrica / Chiave dinamometrica / Chave dinamométrica / Clé dynamométrique / Dynamometrische sleutel



Ref.	info	🔩	EAN
08-823	3/8", 10 – 60 Nm	1/10	5907558444544
08-824	3/8", 20 – 100 Nm	1/10	5907558444551
08-825	1/2", 40 – 200 Nm	1/10	5907558444568
08-826	1/2", 60 – 350 Nm	1/4	5907558444599



Ref.	info	🔩	EAN
08-827	1/2", 20 – 210 Nm	1/10	5907558444575
08-828	1/2", 60 – 350 Nm	1/10	5907558444582

Kątomierz do dokręcania śrub

Torque angle gauge / Winkelmesser zum Schraubenziehen / Угломір для затяжки болтов / Кутомір для дозвинтвання гвинтів / Szögmérő csavar meghúzáshoz / Raportor la stringerea șuruburilor / Угломір к утахованні шрубів / Угломір крутiaceho momentu / Kutomer za privijanje vijakov / Varžtu užspaidimo kamp matuoklis / Leņķmērs skrūvju pievilkšanai / Nurgatõõdik poltide pingutamiseks / Ъгломер за динамометричен ключ / Kutometer za zatezanje vijaka / Угломер за завртanje šrafova / Γωνιόμετρο σύσφιξης βιδών / Escuadra para atornillar tornillos / Goniometro per avvitare le viti / Transferidor para aparafusar / Clé de serrage angulaire

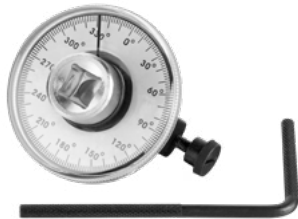

Ref.	🔩	EAN
08-830	1/12	5907558414770

Przedłużka

Extension bar / Verlängerung / Удлинитель / Подожжувач / Toldószár / Prolongitor / Produžovák / Predženie / Podaljšek / Ilgiklis / Pagarinātājs / Pikenudsvarras / Удљенустен / Produzenu poluga / Προέκταση / Alargadera / Prolunga / Extensió / Prolongation / Verlengstuk



Ref.	L[mm]	⌀	EAN
08-251	50	20/200	5907558403916
08-252	75	20/200	5907558403923
08-253	100	25/50	5907558403930
08-254	150	25/50	5907558403947



Ref.	L[mm]	⌀	EAN
08-151	75	20/200	5907558403732
08-152	125	20/200	5907558403749
08-153	150	20/100	5907558403756



Ref.	L[mm]	⌀	EAN
08-552	125	10/50	5907558402636
08-554	250	10/50	5907558402643



Ref.	L[mm]	⌀	EAN
08-350	100	10/40	5907558404296
08-351	200	10/20	5907558404302
08-352	400	0/10	5907558404418

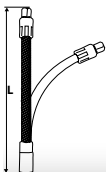

Przedłużka elastyczna
Flexible extension
Удлинитель гибкий



Ref.	L[mm]	M _t max[Nm]	⌀	EAN
08-557	140	5	25/100	5907558402667

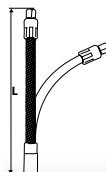

Przedłużka elastyczna
Flexible extension
Удлинитель гибкий



Ref.	L[mm]	M _t max[Nm]	⌀	EAN
08-558	190	40	10/80	5907558402674

Przegub

Articulated joint / Gelenk / Шарнир / Сустав / Kardáncskülg / Articulatio / Kloub / Соп / Zglob / Lankstus / Sarmirs / Klamber / Шарнир / Zglob / Zglob / Μεντεός / Articulación / Giunto articolato / Articulatio / Articulation / Spilverbinding

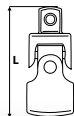

Ref.	L[mm]	⌀	EAN	
08-255	1/4"	35	50/400	5907558403954
08-154	3/8"	50	50/400	5907558403763
08-551	1/2"	65	10/80	5907558402629

Pokręto

Wheel / Drehknopf / Вороток / Маховик / T-hajtókar / Clupă / Otačný knoflík / Ovládací koliesko / Raglja / Rankena / Grietzvite / Nupp / Върток / K otáčiči / Ručica / Паўло / Mango / Barra o T scovrelle / Bořta / Tourne-à-gauche / Draaiknop

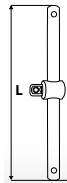

Ref.	L[mm]	⌀	EAN	
08-254	1/4"	110	20/200	5907558403961
08-155	3/8"	165	20/100	5907558403770
08-555	1/2"	250	5/25	5907558402650
08-353	3/4"	460	10/10	5907558404425

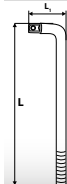

Ref.	L[mm]	L ₁ [mm]	⌀	EAN	
08-556	1/2"	250	75	0/40	5907558408607
08-357	3/4"	450	110	0/10	5907558405873

Rękojeść z przegubem

Flex handle / Handgriff mit Gelenk / Вороток / Рувиця з шарниром / Hajtókar, csuklós / Maner cu articulatie / Kloubové vratidlo / Křibová rukovát / Ročaj z zglobom / Rankena su lankstu / Pagarinātājs mucipatlēgai / Ligendiga kāpēdie / Ръкохватка с шарнир / Drška sa zglobom / Drška sa zglobom / Μανέκα ολιθαίνουσα / Mango con articulación / Impugnatura telescopica / Cabo con Articulatio / Poignée articulée / Handvat met spilverbinding



Ref.	L[mm]	⌀	EAN
08-559	250	10/40	5907558403367
08-560	450	10/20	5907558403374

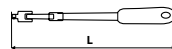

Ref.	L ₁ [mm]	L ₂ [mm]	⌀	EAN
08-553	470	620	5/20	5907558409598



Ref.	L[mm]	⌀	EAN
08-356	510	0/10	5907558404456

Redukcja

Adaptor / Reduzierstück / Переходник / Перехідник / Adapter / Adaptor / Reducce / Redukcia / Adapter / Adaptors / Páreja / Аданпор / Adapter / Προσαρμογέας / Adaptador / Adattatore / Redução / Réduction / Reductiestuk



Ref.	L[mm]	Ra[mm]	⌀	EAN
08-562	26	1/4" M x 3/8" F	10/100	5907558403329
08-563	37	3/8" M x 1/2" F	10/100	5907558403336
08-565	50	1/2" M x 3/4" F	40/40	5907558403350
08-564	46	3/4" M x 1/2" F	10/100	5907558403343

Klucze nasadowe

Socket wrenches / Steckschlüssel / Набор сменных головок / Ключи торцевые / Dugókulcskészlet / Trusa tubulare / Nástrčné kľúče / Nástrčné kľúče / Nasadni ključji / Verziérakció antgaliak / Nominámo galvu komplekts / Padrinnvõtmed / Сменными наконечниками за ключевые / Nasadni ključevci / Ključevci natikači / Zet me karbókia / Llaves de vaso / Set di bussole SuperLock / Chaves tubulares / Clefs à douilles / Dopsleutels

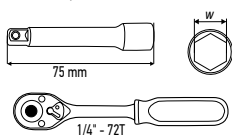

nasadki wykonane w technologii Superlock
sockets manufactured in Superlock technology
nasadki wykonane po technologii Суперлок



Ref.	W [mm]	Б	EAN
08-652	4, 4.5, 5, 5.5, 6, 7, 8, 9, 10, 11, 12, 13	5/20	5907558412963

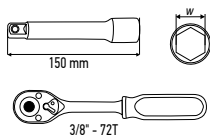

Ref.	W [mm]	Б	EAN
08-653	8, 10, 12, 13, 14, 16, 17, 19, 21, 22	6/24	5907558412970

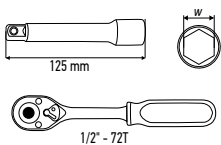

nasadki wykonane w technologii Superlock
sockets manufactured in Superlock technology
nasadki wykonane po technologii Суперлок



Ref.	W [mm]	Б	EAN
08-654	8, 10, 12, 13, 14, 16, 17, 19, 21, 22	6/12	5907558412987

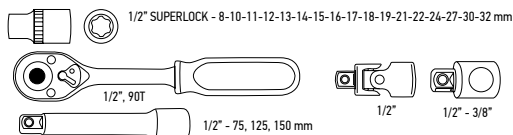

Ref.	Б	EAN
08-694	1/5	5907558440034

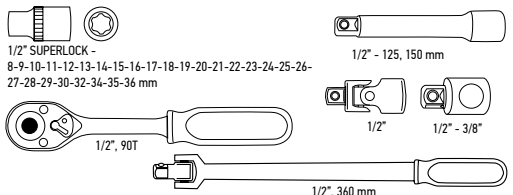

Ref.	Б	EAN
08-692	1/4	5907558440034

Klucze nasadowe

Socket wrenches / Steckschlüssel / Набор сменных головок / Ключи торцевой / Dugókulcskészlet / Trusa tubulare / Nástrčné kľúče / Nástrčné kľúče / Nasadni ključci / Veržlerakció antgaliai / Nominámo galvu komplekts / Padriņvārdmed / Сменными наконечниками для ключов / Nasadni ključevci / Ključevci natikači / İst me karubákia / Llaves de vaso / Set di bussolo SuperLock / Chaves tubulares / Clefs à douilles / Dopsleutels



1/2" SPLINE -

10-11-12-13-14-15-16-17-18-19-20-21-22-23-24-27-30-32 mm

1/4" SPLINE -

4-4.5-5-5.5-6-7-8-9-10-11-12-13 mm

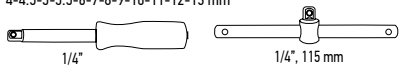

1/4"

1/4", 115 mm

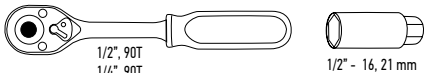

1/2", 90T

1/4", 90T

1/2" - 16, 21 mm



1/2", 1/4"

1/2" - 3/8"

1/2" - 125, 250 mm

1/4" - 50 mm

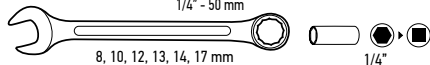

8, 10, 12, 13, 14, 17 mm

1/4"

1/4 - TT - 10-15-20-25-27-30-40

PZ - 1-2-3

PH - 1-2-3

SL - 4.5-6, 5-8 mm

HEX - 3-4-5-6-7-8 mm



Ref.	⊞	EAN
08-690	0/10	5907558440010



1/4" - 4-4.5-5-5.5-6-7-8-9-10-11-12-13-14 mm



1/4"

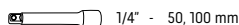

1/4" - 50, 100 mm

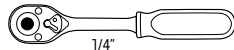

1/4"

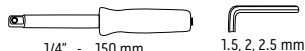

1/4" - 150 mm



1.5, 2, 2.5 mm



1/4" - 150 mm



1/4" - SL4-SL5.5-SL7

PH1-PH2-PH3

PZ1-PZ2-PZ3

T10-T15-T20-T25-T30-T40

H3-H4-H5-H6-H7-H8

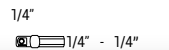

1/4"

1/4" - 1/4"

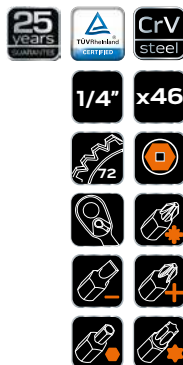

Ref.	⊞	EAN
08-660	0/10	5907558417319



1/2" - 10-11-12-13-14-15-16-17-18-19
20-21-22-23-24-27-30-32 mm

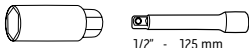

1/2" - 16, 21 mm

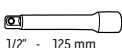

1/2" - 125 mm



1/2" - 72T

1/2"

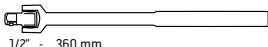

1/2" - 360 mm



1/2" - 250 mm

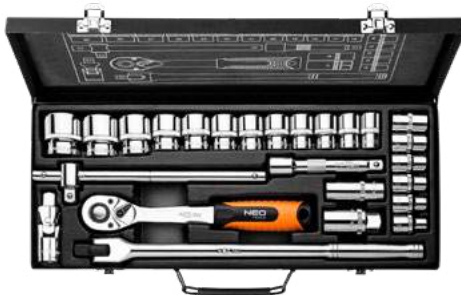

Ref.	⊞	EAN
08-674	0/4	5907558421606

Klucze nasadowe

Socket wrenches / Steckschlüssel / Набор сменных головок / Ключи торцевой / Dugókulcskészlet / Trusa tubulare / Nástrčné klúče / Nástrčné klúče / Nasadni kjučiči / Veržlerakció antalgai / Nomainäma gutvu komplekts / Padrunvõtmed / Сменная накруйница за ключове / Nasadni kjučiči / Ključevni natičaki / İst set karubđaka / Llaves de vaso / Set bussolle / Chaves articuladas / Clefs à douilles / Dopsleutels

3/4" - 19-21-22-23-24-26-27-29-30-32-35-36-38-41-46-50 mm

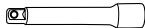

100, 200, 400 mm

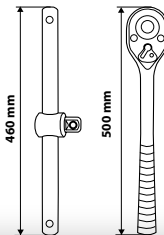

Ref.	⊞	EAN
08-061	0/1	5907558404173

1/4" - 4-4.5-5-5.5-6-7-8-9-10-11-12-13-14 mm

1/4" - 4-4.5-5-5.5-6-7-8-9-10-11-12-13-14 mm

1/4" - E4-E5-E6-E7-E8-E10

1/4" - 72T

1/4" - 50, 100, 150 mm

1/4" - 110 mm

1/4"

1/4" - SL4-SL5-SL7
PH1-PH2-PH3
PZ1-PZ2-PZ3
T8-T10-T15-T20-T25-T30-T40
H3-H4-H5-H6-H7-H8

1/4" 30 mm

1/4" - 140 mm



Ref.	⊞	EAN
08-679	5/10	5907558422139

1/2" - 10-11-12-13-14-15-16-17-18-19-22-24 mm



1/2" - 16 mm



1/2" - 13-17-19 mm

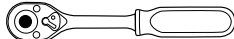

1/2"

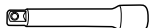

1/2" - 250 mm



1/2"



1/2"



Ref.	⊞	EAN
08-661	0/5	5907558417357

Klucze nasadowe

Socket wrenches / Steckschlüssel / Набор сменных головок / Ключи торцевой / Dugókulcskészlet / Trusa tubulare / Nástrčné kľúče / Nástrčné kľúče / Nasadni ključiči / Veržlerakció antgaliak / Nominátno galvu komplekts / Padrunvõtmed / Сменными крайници за ключове / Nasadni ključevci / Ključevci natičaki / Зет ме карбóкка / Llaves de vaso / Chavi a bussola / Chaves articuladas / Clefs á douilles / Dopsleutels

 1/2" - 8 - 9 - 10 - 11 - 12 - 13 - 14 - 15 - 16 - 17 - 18 - 19 - 20 - 21 - 22 - 24 - 27 - 30 - 32 mm

 1/2" - 10-12-14-15-17-19 mm

 1/2" - 16, 21 mm

 1/2"

 1/2" - 125, 250 mm

 1/2"

 1/2"



25 years
WARRANTY

TÜV Rheinland
CERTIFIED

CrV
steel

x32

1/2"

72





Ref.	Б	EAN
08-662	1/3	5907558417364

 1/2" - 10-11-12-13-14-15-16-17-18 -19-20-21-22-24-27-30-32 mm

 1/2" - 10-11-12-13-14-15-17-19 mm

 1/2" - 16, 21 mm

 1/2"

 1/2" - 125, 250 mm

 1/2"  1/2"

 1/2" - 5/16"

5/16" - FD8-FD10-FD12

PH1-PH2-PH3-PH4

PZ1-PZ2-PZ3-PZ4

T20-T25-T30-T40-T45-T50-T55

H4-H5-H6-H8-H10-H12-H14

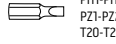



25 years
WARRANTY

TÜV Rheinland
CERTIFIED

CrV
steel

x58

1/2"

72

















Ref.	Б	EAN
08-663	0/4	5907558417296

NEO
TOOLS

NARZĘDZIA MECHANICZNE

MECHANICAL TOOLS

МЕХАНИЧЕСКИЕ ИНСТРУМЕНТЫ

Ключе насadowe

Socket wrenches / Steckschlüssel / Набор сменных головок / Ключи торцевой / Dugókulcskészlet / Trusa tubulare / Nástrčné kľúče / Nástrčné klúče / Nasadni ključji / Veržlerakció antgaliak / Nominaiamo galvu komplekts / Padrūnūmied / Сменная накруйница за ключове / Nasadni ključjevi / Ključjevi natičaki / Set ме карубка / Llaves de vaso / Set bussole / Chaves articuladas / Clefs à douilles / Dopsleutels



1/2" - 10-11-12-13-14-15-16-17-18-19
20-21-22-23-24-27 mm

1/4" - 4-5-5.5-6-7-8-10-11-12-13 mm

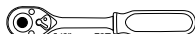

1/2" - 72T
1/4" - 72T



1/2" 1/2"

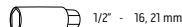

1/2" - 16, 21 mm



1/2" - 125, 250 mm



1/4" - 100 mm

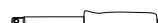

1/4" - 150 mm



1/4"



1.5-2-2.5 mm



1/4" - TX8, TX10, TX15, TX20, TX25, TX27,
TX30, TX40, PH0, PH1, PH2, PH3,
PZ1, PZ2, PZ3, SL4, SL5.5, SL7, HEX 3,
4, 5, 6, 8, 10, 1/8", 9/64", 5/32",
3/16", 7/32", 1/4", 5/16", SPLINE 6, 8



Ref.	С	EAN
08-673	0/4	5907558421613



1/2" - 14-15-16-17-18-19-20-22-24-27-30-32 mm

1/4" - 4, 4.5-5-5.5-6-7-8-9-10-11-12-13-14 mm



1/2" - 16, 21 mm



1/2" - 72T

1/4" - 72T



1/4" - 150 mm



1/4" - 150 mm

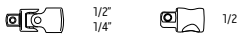

1/2" 1/2"

1/4"



1/2" - 125, 250 mm



1/4" - 50, 100 mm



1/4" - 115 mm

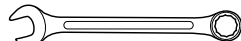

8-10-11-12-13-14-17-19-22 mm



1/2" - 5/16"

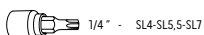

1/4" - SL4-SL5-SL7

PH1-PH2

PZ1-PZ2

T8-T10-T15-T20-T25-T30

H3-H4-H5-H6

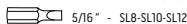

5/16" - SL8-SL10-SL12

PH3-PH4

PZ3-PZ4

T40-T45-T50-T55

H8-H10-H12-H14



Ref.	С	EAN
08-672	0/4	5907558421620

Klucze nasadowe

Socket wrenches / Steckschlüssel / Набор сменных головок / Ключи торцевые / Dugkulcskészlet / Trusa tubulare / Nástrčné kľuče / Nástrčné kľuče / Nasadni kľučiči / Veržlerakció antgatalai / Nomainäma gutvu kompleks / Padrunvātnēd / Сменными наконечниками за ключовые / Nasadni kľučiči / Kľučičeví natičakí / Ключевыи натиакá / Llaves de vaso / Chavi a bussola / Chaves articuladas / Clefs à douilles / Dopsleutels

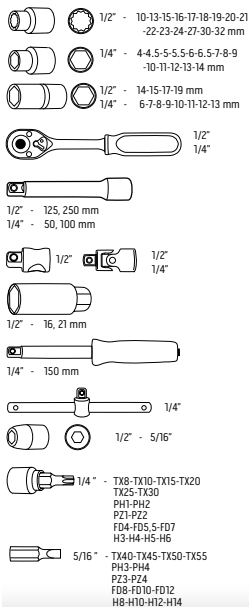

Ref.	♂	EAN
08-664	0/4	5907558417302

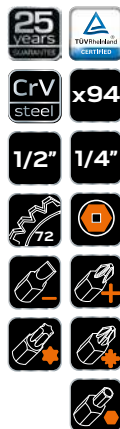
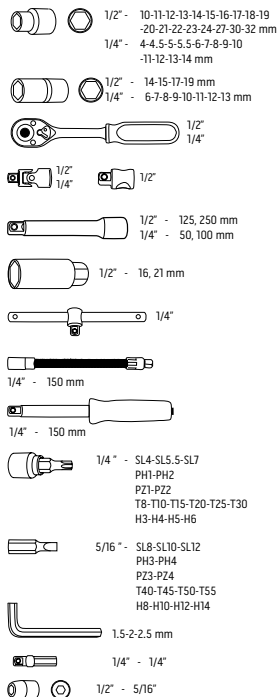

Ref.	♂	EAN
08-665	0/4	5907558417371

Klucze nasadowe

Socket wrenches / Steckschlüssel / Набор сменных головок / Ключи торцевые / Dugókulcskészlet / Trusa tubulare / Nástrčné kľúče / Nástrčné klúče / Nasadni ključji / Veržlerakció antgaliak / Nominaiamo galvu komplekts / Padriņlūņi / Сменными наконечниками за ключовые / Nasadni ključevci / Ključevci natičaki / İstet me karaböğası / Llaves de vaso / Chavi a bussola / Chaves articuladas / Clefs à douilles / Dopsleutels

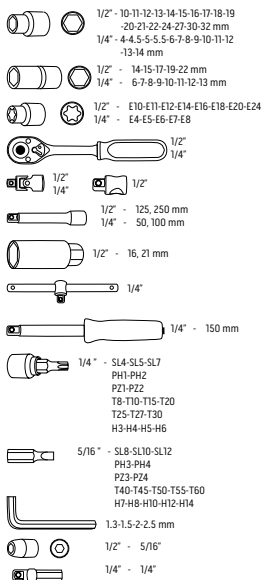

Ref.	Г	EAN
08-666	0/4	5907558417340

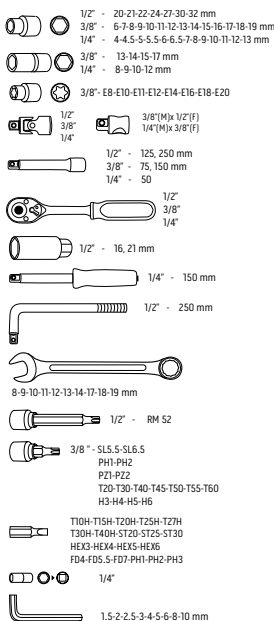

Ref.	Г	EAN
08-667	0/2	5907558417333

Klucze nasadowe

Socket wrenches / Steckschlüssel / Набор сменных головок / Ключи торцевой / Dugokulcskészlet / Trusa tubulare / Nástrčné kľúče / Nástrčné klúče / Nasadni ključvi / Verziérakció antgalari / Nominainamo galvu komplekts / Padrunvõetmed / Сменная накрайница за ключове / Nasadni ključevni / Ključevni natičaki / Σετ με καροβάρια / Llaves de vaso / Chavi a bussola / Chaves articuladas / Clefs à douilles / Dopsleutels

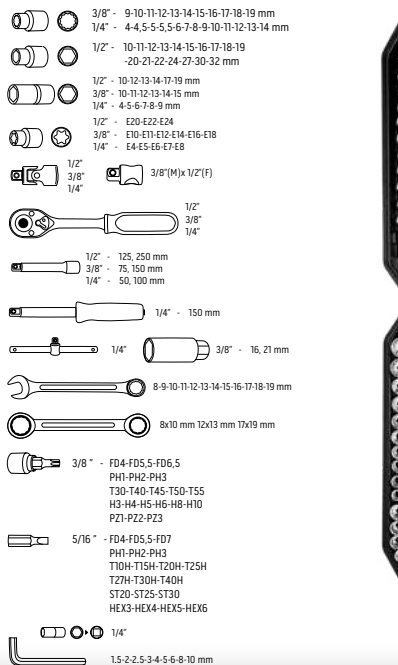

Ref.	⊞	EAN
08-668	0/2	5907558417326

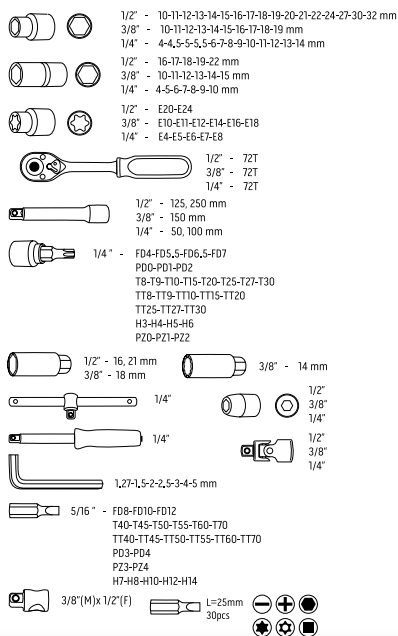

Ref.	⊞	EAN
08-680	0/2	5907558422146

Klucze nasadowe

Socket wrenches / Steckschlüssel / Набор сменных головок / Ключи торцевые / Dugókulcskészlet / Trusa tubulare / Nástrčné kľúče / Nástrčné kľúče / Nasadni ključci / Veržlerakció antgaliak / Nominiamo galvu komplekts / Padrūnrotmed / Сменными наконечники за ключовые / Nasadni ključevci / Ključevci natičaki / Set με καρούβια / Llaves de vaso / Set bussole / Chaves articuladas / Clefs à douilles / Dopsleutels



1/2" - 10-11-12-13-14-15-17-19-20-21-22-24-27-30-32 mm

3/8" - 10-11-12-13-14-15-16-17-18-19 mm

1/4" - 4-5-5.5-6-6.7-8-9-10-11-12-13-14 mm

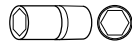

1/2" - 16-17-18-19-22 mm

3/8" - 10-11-12-13-14-15 mm

1/4" - 4-5-6-7-8-9-10 mm



1/2" - E18- E20- E22- E24

3/8" - E8- E10- E12- E14- E16

1/4" - E4- E5- E6- E7- E8

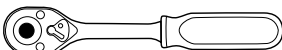

1/2" - 72T; 3/8" - 72T; 1/4" - 72T

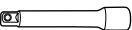

1/2" - 125, 250 mm

3/8" - 125 mm

1/4" - 50, 100 mm



1/2" - 16, 21 mm

3/8" - 18 mm

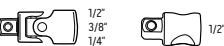

1/2"

3/8"

1/4"

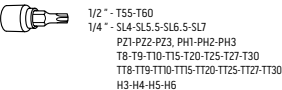

1/2" - T55-T60

1/4" - SL4-SL5.5-SL6.5-SL7

PZ1-PZ2-PZ3, PH1-PH2-PH3

T8-T9-T10-T15-T20-T25-T27-T30

TT8-TT9-TT10-TT15-TT20-TT25-TT27-TT30

H3-H4-H5-H6

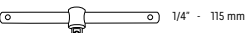

1/4" - 115 mm



1/4" - 210 mm



1/4" - 150 mm

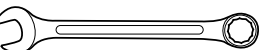

8-9-10-11-12-13-14-15-16-17-18-19 mm

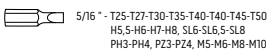

5/16" - T25-T27-T30-T35-T40-T40-T45-T50

H5-H6-H7-H8, SL6-SL6.5-SL8

PH3-PH4, PZ3, PZ4, M5-M6-M8-M10

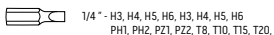

1/4" - H3, H4, H5, H6, H3, H4, H5, H6

PH1, PH2, PZ1, PZ2, T8, T10, T15, T20,

T25, TT10, TT15, TT20, TT25, TT40,

TT8, TT10, TT20, TT20, TT25, M5, M6,

M8, SL4, SL5, SL5.5, TRI-WING 1, 2, 3,

TORQ 6, 8, 10, S1, S2, SL4, SL6, SL8



1/2" - 5/16"

3/8" - 5/16"

1/4" - 5/16"

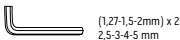

(1.27-1.5-2mm) x 2

2.5-3-4-5 mm



25 years

TUV NORD CERTIFIED

CrV steel

x219

1/2"

3/8"

1/4"

72

+

+

+

+

+

+

+

Ref.	☞	EAN
08-671	0/2	5907558421637

Klucze nasadowe

Socket wrenches / Steckschlüssel / Набор сменных головок / Ключи торцевые / Dugókulcskészlet / Trusa tubulare / Nástrčné kľúče / Nástrčné kľúče / Nasadni ključji / Veržlerakció antgallai / Nomináimó galvu komplekts / Padrinvõtmed / Сменными наконечники за ключовые / Nasadni ključjevi / Ključevni natičaki / Set me karubákia / Llaves de vaso / Set bussole / Chaves articuladas / Clefs à douilles / Dopsleutels



1/2" - 10-13-15-16-17-18-19-20-21-22-23-24-27-30-32 mm
 7/16", 1/2", 9/16", 5/8", 11/16", 3/4", 13/16", 7/8"
 3/8" - 10-11-12-13-14-15-16-17-18-19 mm
 1/4" - 3,5-4-4,5-5-5,5-6-6,5-7-8-9-10-11-12-13-14 mm
 3/8", 11/32", 5/16", 9/32", 1/4", 5/32", 3/16"



1/2" - 15-16-17-18-19-22 mm
 3/8" - 10-11-12-13-14-15 mm
 1/4" - 4-5-6-7-8-9-10 mm



1/2" - E16-E18-E20-E22-E24
 3/8" - E10-E11-E12-E14
 1/4" - E4-E5-E6-E7-E8

1/2" - 16, 21 mm

3/8" - 18 mm

3/8" - 14 mm

1/2" - 125, 250 mm

3/8" - 75, 250 mm

1/4" - 50, 100 mm

9pcs

1/4" - 110 mm

1/4"

1/4"

1/4"

1/2" - T2T
 3/8" - T2T
 1/4" - T2T

1/2" 1/2"
 3/8" 3/8"
 1/4" x 2 1/4"

1/2"
 3/8"

1/4" x 1/4"
 1/4" x 3/8"

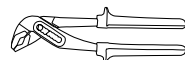

8-9-10-11-12-13-14-15-17-19-22 mm

L=75mm 8pcs

5/16" L=30mm 24pcs

L=25mm 60pcs



Ref.	☞	EAN
08-681	1/2	5907558422153

Klucze nasadowe

Socket wrenches / Steckschlüssel / Набор сменных головок / Ключи торцевые / Dugókulcskészlet / Trusa tubulare / Nástrčné kľúče / Nástrčné kľúče / Nasadni ključci / Veržlerakció antgai / Nomináimó galvu komplekts / Padrinnötmed / Сменными накрайницами за ключове / Nasadni ključevi / Ključevi natičaki / Set me karubáka / Llaves de vaso / Set bussole / Chaves articuladas / Clefs à douilles / Dopsleutels

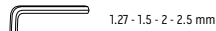
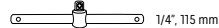
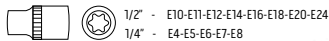
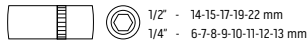
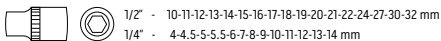

1/4" - TX - 8-10-15-20-25-27-30
PH - 1-2
PZ - 1-2
SL - 4-5.5-7 mm
HEX - 3-4-5-6 mm



1/2", 30 mm - TX - 40-45-50-55-60
PH - 3-4
PZ - 3-4
SL - 8-10-12 mm
HEX - 7-8-10-12-14 mm



25 years
WARRANTY

TÖRTELEKES
KÉRTÉK

CrV
steel

1/2"

1/4"

x111

72

STRONG
CASE

STRONG
CASE
ERGO

Ref.	📦	EAN
08-910	1/4	5907558442113

Klucze nasadowe

Socket wrenches / Steckschlüssel / Набор сменных головок / Ключи торцевые / Dugókulcskészlet / Trusa tubulare / Nástrčné kľúče / Nástrčné kľúče / Nasadni ključji / Veržlerakció antgallai / Nominainno galvu komplekts / Padrinvõtmed / Сменными наконечники за ключовые / Nasadni ključevji / Ključevji natičakci / Set με καρυβάκια / Llaves de vaso / Set bussole / Chaves articuladas / Clefs à douilles / Dopsleutels

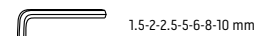
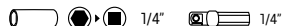
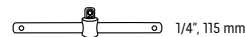
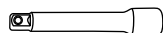
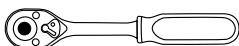
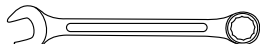
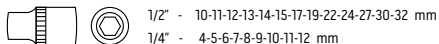

1/2", 30 mm - TX-10-15-20-25-30
PH-0-1-2-3
PZ-1-2-3
SL-3-4-5-5-7 mm
HEX-2-3-4-5-6 mm



25
years
warranty

100%
aluminum
cutting
tool

CrV
steel

1/2"

1/4"

x77

72

72

+

+

+

+

+

+

+

ERGO
CASE

ERGO

Ref.	1/4	EAN
08-915	1/4	590755842120

NEO
TOOLS

NARZĘDZIA MECHANICZNE

MECHANICAL TOOLS

МЕХАНИЧЕСКИЕ ИНСТРУМЕНТЫ

Zestaw narzędzi

Tool and socket set / Werkzeugsatz / Набор инструментов / Инструмент з насадками, набор / Dugökülés és szerszám / Set scule de grădină / Sada nářadí / Súprava nářadla kombi / Garnitura orodij / frankij komplektas / Instrumentu komplekts / Tööriistade ja radrunite komplekt / Комплект инструменти / Set uredaja / Set alata / Συλλογή εργαλείων / Juego de herramientas / Set di attrezzi / Kit de ferramentas / Jeu d'outils / Gereedschapset

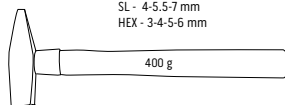
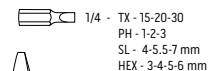
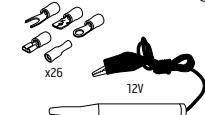
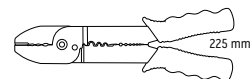
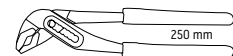
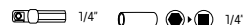
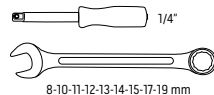
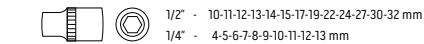

25 years
GUARANTEED

TÜV Rheinland
CERTIFIED

CrV
steel

1/2"

1/4"

x100

72

STRONG
CASE

ERGO

Ref.	☞	EAN
08-920	1/2	5907558442137

Klucze nasadowe

Socket wrenches / Steckschlüssel / Набор сменных головок / Ключи торцевой / Dugakülcsészlet / Trusa tubulare / Nástrčné kľuče / Nástrčné kľuče / Nasadni ključiči / Veržleraktio angalioi / Nominátno galvu komplekts / Padrullvõtmed / Сменная накруйница за ключове / Nasadni ključeviči / Ključeviči patikavči / Set me karubákia / Llaves de vaso / Set bussole / Chaves articuladas / Clefs à douilles / Dopsleutels



1/4" - 5, 5.5, 6, 7, 8, 9, 10, 11, 12, 13, 14 mm

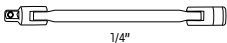

1/4"



1/4" - 4, 5, 6, 7, 8 mm

PH1, PH2, PH3,
PZ1, PZ3, PZ2x2,
T8, T9, TT10, TT15, TT20, TT25,
TT27, TT30, TT40
H2, H2.5, H3, H4, H5, H6, H7, H8



Ref.	⊕	EAN
08-603	0/20	5907558409307

⊕ 5 - 6 - 8 - 9 - 10 - 12 mm



Ref.	⊕	EAN
09-570	6/24	5907558450453

Klucz sześciokątny

Hex key / Sechskantschlüssel / Ключ шестигранный / Ключ шестигранный / Imbuskulcs / Cheie cu șase laturi / Kľuč šestihranný / Kľuč imbusový / Imbus kľuč / Šestiakampis raktas / Šeškansu atslėgi / Kuuskant-mutrivõtvi / Лумбусы 6мм, / Ключ имбус / Ключ имбус / Εξαγωνικό κλειδί / Llave hexagonal / Chiave esagonale / Chave hexagonal / Clef hexagonale / Zeskantsleutel



L



Ref.	⊕ [mm]	L [mm]	L [mm]	⊕	EAN
09-530	1.5	77	14	0/1500	5907558414004
09-531	2.0	81	16	0/1500	5907558414011
09-532	2.5	87	18	0/1500	5907558414028
09-533	3.0	94	20	0/1500	5907558414035
09-534	4.0	103	24	0/1000	5907558414042
09-535	4.5	108	26	0/800	5907558414059
09-536	5.0	115	28	0/500	5907558414066
09-537	5.5	122	30	0/500	5907558414073
09-538	6.0	129	32	0/500	5907558414080
09-539	7.0	136	34	0/300	5907558414097
09-540	8.0	147	36	0/200	5907558414103
09-541	9.0	159	38	0/200	5907558414110
09-542	10.0	170	40	0/150	5907558414127
09-543	12.0	190	45	0/80	5907558414134
09-544	13.0	205	48	0/80	5907558414141
09-545	14.0	216	54	0/60	5907558414158
09-546	17.0	245	63	0/40	5907558414165

Klucz Torx

Torx key / Torx-Schlüssel / Ключи Torx / Ключ шестигранный «torx» / Torx kulcs / Chei de tip "torx" / Kľuč Torx / Súprava torx kľúčov (krátke) / Garnitura kľučev torx / Torx raktų komplektas / Torx atslėgių komplekts / "Torx" vāimete komplekts / Лумбусы компл. / Ключ имбус torx set / Kľuc imbus set / Συλλογή εξαγωνικών κλειδίων / Llaves Allen / Chiavi esagonali colorate / Chaves hexagonais / Clefs à 6 pans / Zeskantsleutel



L

- z otworem
- tamperproof
- c отверстием



Ref.	⊕ [mm]	L [mm]	L [mm]	⊕	EAN
09-550	T10	77	14	0/1500	5907558414172
09-551	T15	84	16	0/1500	5907558414189
09-552	T20	92	18	0/1000	5907558414196
09-553	T25	101	20	0/1000	5907558414202
09-554	T27	111	24	0/500	5907558414219
09-555	T30	122	28	0/500	5907558414226
09-556	T40	136	32	0/400	5907558414233
09-557	T45	152	36	0/300	5907558414240
09-558	T50	176	40	0/200	5907558414257
09-559	T55	183	44	0/100	5907558414264

Klucze sześciokątne

Hex key set / Sechskantschlüssel / Ключи шестигранные / Ключ шестигранный / Imbuskulcs készlet / Set chei cu șase laturi / Šestihranný kľuč / Súprava imbus kľúčov (dlhé) / Garnitura imbus kľučev / Šestiakampis raktų komplektas / Šeškansu atslėgių komplekts / Kuuskant-mutrivõtmete komplekt / Лумбусы компл. / Ключ имбус set / Kľuc imbus set / Συλλογή εξαγωνικών κλειδίων / Llaves Allen / Chiavi esagonali colorate / Chaves hexagonais / Clefs à 6 pans / Zeskantsleutel

⊕	L [mm]	L [mm]
1.5	91	16
2.0	103	19
2.5	115	20
3.0	130	23
4.0	145	29
5.0	166	35
6.0	188	38
8.0	208	43
10.0	230	50

- kuliste końcówki o kącie roboczym do 30 stopni
- kolorowy kod ułatwiający wybór rozmiaru
- SNCM+V wysoko gatunkowa stal stopowa

- rounded tips with working angle of up to 30 degrees
- color-coded for easy size selection
- SNCM+V extra-fine alloy steel

- наконечники шаровидные, рабочий угол 30°
- цветовая кодировка - удобный выбор размера
- SNCM+V высококачественная легированная сталь

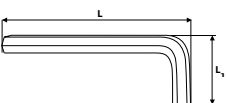

Ref.	⊕	EAN
09-512	6/48	5907558403428

NEO
TOOLS

NARZĘDZIA MECHANICZNE

MECHANICAL TOOLS

МЕХАНИЧЕСКИЕ ИНСТРУМЕНТЫ

Klucze sześciokątne

Hex key set / Sechskantschlüssel / Ключи шестигранные / Ключ шестигранный / Imbusz kulcs készlet / Set chei cu șase laturi / Šestihránný klíč / Súprava imbus klúčov (dlhá) / Garnitura imbus ključev / Sešakotni raktų kompleksas / Seškanšu atslēgu komplekts / Kuuskant-mutrivõtmete komplekt / Лумбџу компн. / Кључ имбус сет / Кључ имбус сет / Συλλογή εξαγωνικών κλειδιών / Llaves Allen / Chiavi esagonali colorate / Chaves hexagonais / Clefs à 6 pans / Zeskantsleutels

- kuliste końcówki o kącie roboczym do 30 stopni
- rounded tips with working angle of up to 30 degrees
- наконечники шаровидные, рабочий угол 30°



Ø [mm]	L [mm]	L ₁ [mm]
2.0	85	18
2.5	90	20
3.0	97	23
4.0	106	28
5.0	118	30
6.0	138	36
8.0	159	40
10.0	180	46

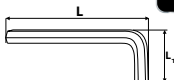

Ref.	♣	EAN
09-513	6/36	5907558403411



Ø [mm]	L [mm]	L ₁ [mm]
1.5	63	15
2.0	75	17
2.5	87	20
3.0	90	23
4.0	100	27
5.0	116	32
6.0	137	37

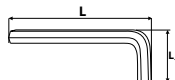

Ref.	♣	EAN
09-517	10/100	5907558410273



- kuliste końcówki o kącie roboczym do 30 stopni
- rounded tips with working angle of up to 30 degrees
- наконечники шаровидные, рабочий угол 30°

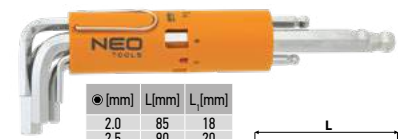

Ø [mm]	L [mm]	L ₁ [mm]
2.0	85	18
2.5	90	20
3.0	97	23
4.0	106	28
5.0	118	30
6.0	138	36
8.0	159	40
10.0	180	46



Ref.	♣	EAN
09-523	10/40	5907558414288



1.5 - 2 - 2.5 - 3 - 4 - 5 - 6 - 8 mm

Ref.	♣	EAN
09-571	6/24	5907558450460



- z końcówką kulistą i magnetyczną
- magnet ball ended
- с магнитным наконечником



Ø [mm]	L [mm]	L ₁ [mm]
1.5	92	15
2.0	100	18
2.5	114	20
3.0	127	22
4.0	143	28
5.0	164	31
6.0	185	37
8.0	205	43
10.0	235	47

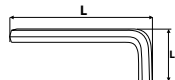

Ref.	♣	EAN
09-515	12/48	5907558409314



- z końcówką kulistą i magnetyczną
- magnet ball ended
- с магнитным наконечником



Ø [mm]	L [mm]	L ₁ [mm]
1.5	92	15
2.0	100	18
2.5	114	20
3.0	127	22
4.0	143	28
5.0	164	31
6.0	185	37
8.0	205	43
10.0	235	47



Ref.	♣	EAN
09-525	6/24	5907558414301



Klucze Torx

Torx key wrench set / Torx-Schlüssel / Ключи Torx / Ключи "Торх" / Torx kulcs készlet / Set chei de tip "torx" / Кључе Торх / Súprava Torx klúčov / Garnitura ključev torx / Raktai TORX / Torx atslēgu komplekts / "Torx" mutrivõtmete komplekt / Лумбџу компн. / Кључ имбус / Κλειδιά Torx / Llaves torx / Set chiavi Torx / Chaves torx / Clefs Torx / Torxsleutels



Ø [mm]	L [mm]	L ₁ [mm]
T10	89	20
T15	105	22
T20	115	23
T25	130	25
T27	146	30
T30	167	35
T40	184	38
T45	204	45
T50	226	50

- kolorowy kod ułatwiający wybór rozmiaru
- color-coded for easy size selection
- цветная кодировка - удобный выбор размера

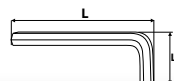

Ref.	♣	EAN
09-518	6/48	5907558420661



Ø [mm]	L [mm]	L ₁ [mm]
TT10	88	20
TT15	93	22
TT20	98	23
TT25	105	24
TT30	119	30
TT40	130	32
TT45	144	37
TT50	160	40



Ref.	♣	EAN
09-514	6/36	5907558403428



Klucze Torx

Torx key wrench set / Torx-Schlüssel / Ключи Torx / Ключи "Torx" / Torx kulcs készlet / Set chei de tip "torx" / Ključ Torx / Súprava Torx ključov / Garnitura klučev torx / Rakitai TORX / Torx atslėgu kompleks / "Torx" multivitrámte komplex / Лумбџуи компн. / Кључ имбус / Кључи Торкс / Llaves torx / Set chavi / Torx / Chaves torx / Clefs Torx / Torxsleutels



Ref.	L [mm]	L ₁ [mm]
TT10	88	20
TT15	93	22
TT20	98	23
TT25	105	24
TT30	119	30
TT40	130	32
TT45	144	37
TT50	160	40



- z otworem
- tamperproof
- с отверстием

Ref.	📦	EAN
09-524	10/40	5907558414295

- z końcówką magnetyczną

- magnet end

- с магнитным наконечником



Ref.	L [mm]	L ₁ [mm]
T10	89	20
T15	105	22
T20	115	23
T25	130	25
T27	146	30
T30	167	35
T40	184	38
T45	204	45
T50	226	50



Ref.	📦	EAN
09-516	12/48	5907558409321



Ref.	L [mm]	L ₁ [mm]
T10	89	20
T15	105	22
T20	115	23
T25	130	25
T27	146	30
T30	167	35
T40	184	38
T45	204	45
T50	226	50



Ref.	📦	EAN
09-526	6/24	5907558414318

T9 - T10 - T15 - T20 - T25 - T27 - T30 - T40



Ref.	📦	EAN
09-573	6/24	5907558450477

Klucze pięciokątne

Pentagonal wrenches / Fünfkantschlüssel / Пятигранные ключи / Ключи-звездичи / Star kulcskészlet / Chei pentagonale / Pětihránné ključ / Páthránné ključ / Ključ zvezda / Penkiakampiai rakitai / Piesčstara atslėgas / Pentskantsvitrámte / Пемтэгрэньні кључэвы / Петэгокатні кључэві / Pentagonalni kљuč / Пэнтэгоува кључи / Llaves pentagonales / Chiavi pentagonalni TS / Chaves de cinco ángulos / Clefs à 5 pans / Vijfkant sleutels



Ref.	L [mm]	L ₁ [mm]
TS10	92	18
TS15	113	20
TS20	116	23
TS25	130	25
TS27	145	30
TS30	165	35
TS40	186	40
TS45	208	45
TS50	232	50

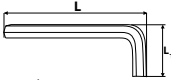

- z otworem
- tamperproof
- с отверстием

Ref.	📦	EAN
09-520	1/36	5907558410280

Klucz płasko-oczkowy

Combination spanner / Maul-Ringschlüssel / Ключ комбинированный / Кључ комбинованиј, рјчкво-накћидниј / Csillag-világkulcs / Cheie combinată / Кључ оцко-плочњ / Кључ ОР / Кључ вљичаство-оброци / Raktas plokščias - kilpinis / Kombinētā atslėga / Universaalne multivitrámte / Кључ звездоаочеч / Кључ комбинирани / Кључ комбиновани / Εργονομικό κључ / Llave combinada / Chiave combinata / Chave plana-de luneta / Clef à fourche-polygonale / Moersleutel



Ref.	⌀ [mm]	L [mm]	📦	EAN	Ref.	⌀ [mm]	L [mm]	📦	EAN
09-706	6	100	0/200	5907558410914	09-723	23	260	5/30	5907558411089
09-707	7	110	5/200	5907558410921	09-724	24	280	5/50	5907558411096
09-708	8	120	5/200	5907558410938	09-725	25	295	5/40	5907558411102
09-709	9	130	5/200	5907558410945	09-726	26	295	5/40	5907558411119
09-710	10	140	5/200	5907558410952	09-727	27	310	5/50	5907558411126
09-711	11	150	5/200	5907558410969	09-728	28	310	5/40	5907558411133
09-712	12	160	5/200	5907558410976	09-729	29	340	4/40	5907558411140
09-713	13	170	5/200	5907558410983	09-730	30	340	4/30	5907558411157
09-714	14	180	5/100	5907558410990	09-732	32	360	4/40	5907558411164
09-715	15	190	5/100	5907558411003	09-734	34	380	4/20	5907558411171
09-716	16	200	5/100	5907558411010	09-736	36	410	5/10	5907558412611
09-717	17	210	5/100	5907558411027	09-738	38	430	5/20	5907558412628
09-718	18	220	5/100	5907558411034	09-741	41	460	2/10	5907558412635
09-719	19	230	5/100	5907558411041	09-746	46	500	5/10	5907558412642
09-720	20	240	5/100	5907558411058	09-747	50	540	5/10	5907558412659
09-721	21	250	5/100	5907558411065	09-748	55	560	0/2	5907558412666
09-722	22	260	5/50	5907558411072	09-749	60	600	0/2	5907558412673



Ref.	⌀ [mm]	L [mm]	📦	EAN	Ref.	⌀ [mm]	L [mm]	📦	EAN
09-406	6	100	25/400	5907558422375	09-419	19	230	10/120	5907558422504
09-407	7	110	25/400	5907558422382	09-420	20	240	10/100	5907558422511
09-408	8	120	25/400	5907558422399	09-421	21	250	10/100	5907558422528
09-409	9	130	25/400	5907558422406	09-422	22	260	10/100	5907558422535
09-410	10	140	25/400	5907558422412	09-423	23	260	10/80	5907558422542
09-411	11	150	25/300	5907558422429	09-424	24	280	10/80	5907558422559
09-412	12	160	25/300	5907558422436	09-425	25	295	10/60	5907558422566
09-413	13	170	25/300	5907558422443	09-426	26	295	10/60	5907558422573
09-414	14	180	25/200	5907558422450	09-427	27	310	10/40	5907558422580
09-415	15	190	25/200	5907558422467	09-428	28	310	10/40	5907558422597
09-416	16	200	25/150	5907558422474	09-429	29	340	10/40	5907558422604
09-417	17	210	25/150	5907558422481	09-430	30	340	10/40	5907558422611
09-418	18	220	10/120	5907558422498	09-432	32	360	10/40	5907558422627

Klucz płasko-oczkowy

Combination spanner / Maul-Ringschlüssel / Ключ комбинированный / Ключ комбінований, рижково-накидний / Csillag-villáskulcs / Cheie combinată / Ključ očko-plochy / Ključ OP / Kjuč vilicasto-obročni / Raktas plokščias - kilpinis / Kombinētā atslēga / Universaalne mutriviti / Ключ звездогаечен / Kjuč kombinirani / Kjuč kombinovani / Γερανοπολύγωνο / Llave combinada / Chiave combinata / Chave plana-de luneta / Clef à fourche-polygonale / Moersteel

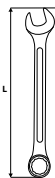

Ref.	○ [mm]	L [mm]	⊖	EAN	Ref.	○ [mm]	L [mm]	⊖	EAN
09-760	8	90	10/200	5907558410198	09-766	14	113	10/200	5907558410259
09-761	9	93	5/200	5907558410204	09-767	15	118	10/120	5907558410266
09-762	10	96	5/200	5907558410211	09-768	16	123	10/120	5907558412765
09-763	11	98	10/200	5907558410228	09-769	17	129	10/200	5907558412772
09-764	12	102	10/200	5907558410235	09-770	18	131	10/120	5907558412789
09-765	13	109	5/200	5907558410242	09-771	19	134	10/150	5907558412796



Ref.	○ [mm]	⊖	EAN
09-791	8, 9, 10, 12, 13, 14, 17, 19 mm	0/20	5907558413090

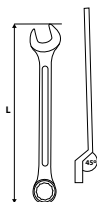

Ref.	○ [mm]	L [mm]	⊖	EAN	Ref.	○ [mm]	L [mm]	⊖	EAN
09-458	8	117	25/400	5907558422634	09-469	19	245	10/120	5907558422696
09-460	10	154	25/400	5907558422641	09-472	22	275	10/80	5907558422702
09-462	12	170	25/300	5907558422658	09-474	24	315	10/60	5907558422719
09-463	13	178	25/200	5907558422665	09-477	27	375	10/40	5907558422726
09-465	15	210	25/200	5907558422672	09-480	30	430	5/0	5907558422733
09-467	17	226	25/150	5907558422689	09-482	32	425	5/30	5907558422740



Ref.	○ [mm]	⊖	EAN
09-350	13 mm	10/100	5907558445237
09-351	17 mm	10/50	5907558445244
09-352	19 mm	10/50	5907558445251



Ref.	○ [mm]	⊖	EAN
09-750	6, 8, 10, 13, 15, 17	0/25	5907558411515
09-751	6, 8, 10, 12, 13, 14, 17, 19	0/25	5907558411522
09-752	6, 7, 8, 10, 11, 12, 13, 14, 15, 17, 19, 22	0/20	5907558411539
09-753	8, 9, 10, 11, 12, 13, 14, 15, 16, 17, 18, 19, 22, 24, 27, 30, 32	0/6	5907558411599
09-754	6, 7, 8, 9, 10, 11, 12, 13, 14, 15, 16, 17, 18, 19, 20, 21, 22, 23, 24, 25, 26, 27, 28, 29, 30, 32	0/4	5907558413113

Klucz płasko-oczkowy skręcony 90°

Offset combination spanner 90° / Ring-Maulschlüssel, 90° verdrehter Griff / Комбинированный ключ с голозой повернутой на 90° / Ключ рижково-накидний, повернутий на кут 90° / Csillag-villáskulcs csavart / Cheie fixa-inelara torsionata 90° / Očkoplochy ključ vlnhuty 90° / Ključ plochy - očkovy s lámanou rúčkou / Kjuč vilicasto-obročni ukrižljeni 90° / Plokščias, kilpinis raktas, šešiakampis 90° / Kombinētā atslēga ar 90° savērpuma tenķi / 90° vītra keeratud teht-silmusviti / Πλοχης γαечен ключ υαεση 90° / Plosnato-okasti ključ savinuti 90° / Vilasto-okasti ključ, pod uglom od 90° / Γερανοπολύγωνο κλειδί με κεφαλή υπό γωνία 90° / Llave combinada torcida 90° / Chiave combinata / Chave plana de luneta, curvada 90° / Clef à fourche - polygonale tordue 90° / Gebogen moersteel 90°

- unikalna skręcona rękojmię lepiej przenosi siłę na łeb śruby, zwłaszcza gdy jest ona mocno zapieczona
- ergonomiczny kształt pozwala lepiej przenosić siłę nacisku z klucza na śrubę

- unique twisted handle is much easier to transfer force onto a bolt head, especially when it is seized
- ergonomic shape allows for better transfer of pressure force onto a bolt head

- уникальная форма рукоятки лучше передает усилие на головку винта, в особенности, если она сильно прикипела
- эргономичная форма позволяет передавать больший крутящий момент на винт



Ref.	W [mm]	⊖	EAN
09-779	8	10/120	5907558420272
09-780	10	10/120	5907558420289
09-782	13	10/120	5907558420302
09-784	17	10/120	5907558420326
09-785	19	5/40	5907558420333

Klucz płasko-oczkowy z grzechotką

Combination spanner with ratchet / Maul-Ringschlüssel mit Ratsche / Ключ комбинированный с трещоткой / Ключ комбинированный рижково-накидной з трісчаткою / Racsnis csillag-villáskulcs / Cheie combinată cu morșică / Odkaplochy ključ s rehtačkou / Račnový OP ključ / Ključ vilicasto-obročni z rajojo / Raktas plokščias - kilpinis su terkšte / Kombinētā atslēga ar reversu / Universaalne multivitrvi parrkataga / Ключ Звездозаочен / Ključ kombinirani / Chiave combinata a cricchetto / Γερανόλυλο και κατάνα / Llave combinada con carroca / Chiave piatta chiusa a cricco / Cheve plana-de luneta z catraca de furar / Clef à fourche-polygonale à cliquet / Moersleutel met ratel

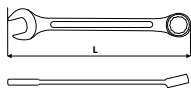

Ref.	Ø [mm]	L [mm]	Ø	EAN	Ref.	Ø [mm]	L [mm]	Ø	EAN
09-063	8	140	10/200	5907558424157	09-069	21	237	10/50	5907558424164
09-064	10	160	10/200	5907558416954	09-042	22	252	5/50	5907558424041
09-065	13	180	10/50	5907558416961	09-043	24	274	5/50	5907558424058
09-066	15	190	10/100	5907558416978	09-044	27	332	6/24	5907558424065
09-067	17	213	0/100	5907558416985	09-045	30	349	6/24	5907558424072
09-068	19	235	10/60	5907558416992	09-046	32	390	8/16	5907558424089



Ref.	Ø [mm]	L [mm]	Ø	EAN	Ref.	Ø [mm]	L [mm]	Ø	EAN
09-051	8	140	10/200	5907558403335	09-062	21	255	10/50	5907558424140
09-052	10	162	10/160	5907558403342	09-053	22	255	5/50	5907558424096
09-055	13	181	10/120	5907558403359	09-054	24	274	5/50	5907558424102
09-057	15	202	10/100	5907558403366	09-056	27	312	5/30	5907558424119
09-059	17	237	10/80	5907558403373	09-058	30	350	6/24	5907558424126
09-061	19	250	10/60	5907558403380	09-060	32	390	8/16	5907558424133



Ref.	Ø [mm]	L [mm]	Ø	EAN
09-320	8 mm	20	10/100	5907558444919
09-321	9 mm	21	10/100	5907558444926
09-322	10 mm	22	10/100	5907558444933
09-323	11 mm	22	10/100	5907558444940
09-324	12 mm	23	10/100	5907558444957
09-325	13 mm	26	5/100	5907558444964
09-326	14 mm	27	5/100	5907558444971
09-327	15 mm	27	5/50	5907558444988
09-328	16 mm	28	5/50	5907558444995
09-329	17 mm	30	5/50	5907558445008
09-330	18 mm	31	5/50	5907558445015
09-331	19 mm	32	5/50	5907558445022
09-332	20 mm	38	5/50	5907558445039
09-333	21 mm	38	5/50	5907558445046
09-334	22 mm	38	5/50	5907558445053
09-335	23 mm	42	5/25	5907558445060
09-336	24 mm	42	5/25	5907558445077
09-337	25 mm	42	5/25	5907558445084
09-338	26 mm	45	5/25	5907558445091
09-339	27 mm	45	5/25	5907558445107
09-340	28 mm	49	5/25	5907558445114
09-341	30 mm	49	5/20	5907558445121
09-342	32 mm	52	5/20	5907558445138



Ref.	Ø [mm]	L [mm]	Ø	EAN
09-360	8 mm	235	10/100	5907558445145
09-361	10 mm	289	10/100	5907558445152
09-362	12 mm	325	10/100	5907558445169
09-363	13 mm	360	5/50	5907558445176
09-364	14 mm	363	5/50	5907558445183
09-365	16 mm	390	5/50	5907558445190
09-366	17 mm	403	5/50	5907558445206
09-367	19 mm	425	5/50	5907558445213
09-368	22 mm	450	5/25	5907558445220

Klucz oczkowy półotwarty

Flare nut wrench / Ringschlüssel halb offen / Ключ разрезной двусторонний / Ключ торцевой нарезной двусторонний / Fékcsakulcs / Cheie piuită în formă de con / Očkový klíč polootevřený / Ključ otvorený očkový / Obročni ključ, odprti / Kilpinis raktas / Bremžu trupu atslēga / Vargamutri vōti / Ключ гаечный / Ključ eccentricni / Ključ / Πολύγωνο κλειδί ημιανοίχτο / Llave de estrella, abierta / Chiave doppia ad anello aperto / Chiave de luneta semi aberta / Clef polygonale demi ouverte / Halfopen ringsleutel

- odkuwany, wzmożniony
- kął odchylenia 15 stopni
- forged, reinforced
- offset angle 15 degrees
- нованный, усиленный
- угол наклона головы 15°



Ref.	Ø [mm]	L [mm]	Ø	EAN	Ref.	Ø [mm]	L [mm]	Ø	EAN
09-141	8x9	130	25/100	5907558404746	09-149	13x14	170	25/100	5907558404784
09-143	9x11	150	10/200	5907558404753	09-151	15x17	195	25/100	5907558404791
09-145	10x12	150	10/200	5907558404760	09-154	19x21	230	10/100	5907558404807

Klucz oczkowy odgięty

Offset ring spanner / Ringschlüssel, gebogen / Ключ накидной изогнутый / Ключ накидный, выгнутый / Csillagkulcs, hajlított / Cheie inelară-cavita / Ključ očkový vuhnutý / Očkový ključ ohnutý / Obročni uprogjeni ključ / Kilpinis raktas, lenktas / Izliekta uzvarosa atslēga / Kovera otsaga silmuvõti / Гнүч гаечный ключ отъёмный / Fleksibilni okasti ključ / Okasti ključ obrnuti / Kliebi polýgonno křupá / Llave de estrella acodada / Chiave polygonale doppia / Cheve de luneta curvada / Clef polygonale contre-coudée / Gebogen ringsleutel



Ref.	Ø [mm]	L [mm]	Ø	EAN	Ref.	Ø [mm]	L [mm]	Ø	EAN
09-906	6x7	170	5/100	5907558411317	09-918	18x19	265	5/50	5907558411379
09-908	8x9	180	5/100	5907558411324	09-920	20x22	290	5/40	5907558411386
09-910	10x11	200	5/100	5907558411331	09-921	21x23	310	4/40	5907558411393
09-912	12x13	210	5/100	5907558411348	09-924	24x27	330	4/40	5907558411409
09-914	14x15	230	5/60	5907558411355	09-925	25x28	330	4/40	5907558411416
09-916	16x17	245	5/100	5907558411362	09-930	30x32	370	4/40	5907558411430

Klucz płaski dwustronny

Double open end spanner / Doppelmouthschlüssel / Ключ рожковый двусторонний / Ключ рожковой двусторонний / Villåskulcs / Cheie puilță dublă cu cavitate deschisă / Klíč plochy oboustranný / Klíč vidlicový / Villčasti ključ / Plokščas divpusis raktas / Raqatsläga ävrisēja / Kahepoole anvatul otsaga väti / Ключ Гаечный / Ключъ вилушкasti / Ключъ вилушкasti / Διπλό γερανικό κλειδί / Llave fija de dos bocas / Chiave a forchetta doppia / Chave plana de duas pontas / Clef à fourche double / Dubbelzijdige vlakke steelet



Ref.	W [mm]	L [mm]	Ø	EAN	Ref.	W [mm]	L [mm]	Ø	EAN
09-806	6x7	120	10/600	5907558411195	09-818	18x19	220	5/100	5907558411256
09-808	8x9	140	10/200	5907558411201	09-819	19x22	234	10/100	5907558411461
09-810	10x11	160	10/300	5907558411218	09-820	20x22	230	5/100	5907558411263
09-812	12x13	170	10/200	5907558411225	09-821	21x23	250	5/100	5907558411270
09-814	14x15	190	10/100	5907558411232	09-824	24x27	270	5/50	5907558411287
09-816	16x17	200	10/100	5907558411249	09-825	25x28	285	5/50	5907558411294
09-817	17x19	220	10/100	5907558411454	09-830	30x32	300	5/50	5907558411300

Klucz płaskie dwustronne

Flat double sided wrenches / Mutterschlüssel, beidseitig / Ключи с открытым зевом двусторонние / Ключи рожковой двобочной / Villåskulcs készlet / Cheie fixa / Klíče ploché oboustranné / Klíče ploché obojstranné / Ploščiti obojstranski ključ / Ploščiti raktai, ävrisēja / Divpusēja plakana atslēga / Kahepooleselehtvõimed / Plochy двусторонни ключове / Dvostrani ploščati ključevi / Dvočeljusni ploščati ključevi / Γερανικό κλειδί δίπλο / Llaves fijas dobles / Chiavi a forchetta doppia / Chaves planas de duas pontas / Clefs à fourches doubles / Vlakke tweezijdige steelets



Ref.	W [mm]	L [mm]	Ø	EAN
09-851	6x7,8x9,10x11,12x13,14x15,16x17,18x19,20x22		0/20	5907558411546
09-852	6x7,8x9,10x11,12x13,14x15,16x17,18x19,20x22,21x23,24x27,25x28,30x32		0/8	5907558413120

Klucz oczkowy wygięty

Offset ring spanner / Ringschlüssel, gebogen / Ключ накладной изогнутой / Ключ накладный, изогнутой / Csillagkulcs hajlított / Cheie inelară semiluna / Očkový klíč zahnutý / Očkový klíč vlnutý / Obročni ključ / Kilpinisi raktas, lenktas / Izliekta uzmazas atslēga / Poalkuu-silmusvöti / Γυγος γαечный ключ отъгнат / Okasti savinut ključ / Okasti izvijeni ključ / Клейди полукружна крота / Llave de estrella de media luna / Chiave doppia poligonale a mezza luna / Chave de luneta curvado / Clef polygonale coude / Uitgebogen ringsleutel

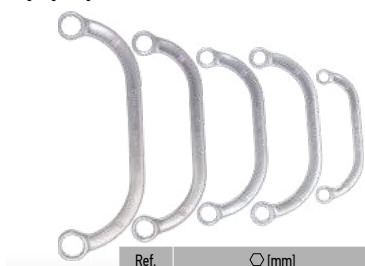

Ref.	W [mm]	L [mm]	Ø	EAN
09-176	9x12, 13x15, 14x17, 16x18, 19x22		0/10	5907558404876

Klucz oczkowe odgięte

Offset ring spanner set / Ringschlüssel gebogen / Ключи накладные колечные / Ключи накладные колечные / Csillagkulcs készlet hajlított / Set chei inelare de deviatie / Očkový klíč vlnutý / Súprava očkových klúčov / Garmitura obročnih ključev, uprogjenih / Kilpinisi, lenktu raktu komplektas / Kombinēto izliekto atslēgu komplekts / „Ofset” multivirtumete komplekt / Ключ Луна / Ключъ окаст / Ключъ окаст / Συλλογή κυρτών πολυγωνικών κλειδιών με κεκλιμένη κεφαλή / Llaves de estrella, acodadas / Chiavi poligonale doppie / Chaves de luneta curvadas / Clefs polygonales contre-coudées / Gebogen ringsleutels



Ref.	W [mm]	Ø	EAN
09-952	6x7,8x9,10x11,12x13,14x15,16x17,18x19,20x22,21x23,24x27,25x28,30x32	0/6	5907558413137

Klucz oczkowe Torx

Offset ring spanner set / Ringschlüssel / Ключи накладные колечные / Ключи накладные / Csillagkulcs készlet torx / Set chei inelare de deviatie / Klíče očkové / Súprava očkových klúčov / Obročni ključ / Kilpinisi raktai / Kombinēto izliekto atslēgu komplekts / Multivirtumete komplekt / Ключ Луна компл. / Ключъ окаст / Πολύγωνα Κλειδιά / Llaves de estrella / Chiavi combinate Torx / Chaves de luneta / Clefs polygonales / Ringsleutels



Ref.	info	Ø	EAN
09-980	T6xT8, T10xT12, T14xT18, T20xT24	20/60	5907558412239

Klucz trzpieniowy nasadowy

T-socket wrench / Vierkant-Aufsteckschlüssel / Ключ торцевой Т-образный / Ключ шестигранный торцевой накладный / T-kulcs / cheie fixare forma T / Nástřkový klíč tyčovitý / T ključ / T ključ, pasadni / T formos raktas / T-veida gala atslēga / T-padruni multivirtuti / T-obrazen ključ / T ključ / T ključ / Καταβιβόκι καρβυδάκι τύπου T / Llave de vaso con mango en T / Chiave a T / Chave tubular / Clef mâle à douilles articulée / Imbusdopsleutel



Ref.	W [mm]	L [mm]	Ø	EAN
09-302	13	300	25/50	5907558414363

Klucz fajkowy

L-type wrench / Pfeifenschlüssel / Рожковый ключ / Ключ торцовый нутовый / Pipakulcs / Cheie tubulară cotită / Zahnutý klíč / Fajkový klíč / Pypkinis raktas / Radziątsłęga / Padrunviti / Ключ пьла / Imbus ključ / Kosočeljusni zavrtjniki ključ / Γερανικό κλειδί / Llave de pipa / Chiave a pipa / Chave de cabo curvo / Clef à pipe / Pijpsleutel

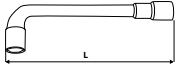

Ref.	Ø [mm]	L [mm]	Ø	EAN	Ref.	Ø [mm]	L [mm]	Ø	EAN
09-203	8	110	10/200	5907558405002	09-208	13	150	10/100	5907558405033
09-205	10	130	10/120	5907558405019	09-210	15	170	10/80	5907558405057
09-207	12	140	10/100	5907558405026	09-212	17	180	10/60	5907558405064
					09-214	19	200	10/40	5907558405071

Klucz nastawny

Adjustable wrench / Schraubenschlüssel / Ключ разводной / Ключ разводный гаечный / Csanvarkulcs / Cheie reglabilă / Ключ регулируемый / Наставительный ключ / Francoski ključ / Reguliuojamas raktas / Bidačslęga / Tellitan viti / Разводжен гаечен ключ / Podesivi ključ / Francuski ključ / Γαλλικό κλειδί / Llave inglesa / Chiave a rullino / Chave regulável / Clef à ouverture réglable / Verstelbaar moersleutel



Ref.	Ra[mm]	Ø	EAN
03-030	5 - 16	5/40	5907558445268
03-031	5 - 27	5/20	5907558445275

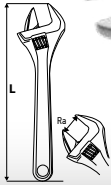

Ref.	L[mm]	Ra[mm]	Ø	EAN
03-010	150	0-24	6/120	5907558404111
03-011	200	0-28.6	6/60	5907558404128
03-012	250	0-32.8	6/48	5907558404135
03-013	300	0-38	6/24	5907558404142

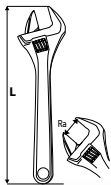

Ref.	L[mm]	Ra[mm]	Ø	EAN
03-015	150	0-34	6/96	5907558412208
03-014	200	0-38	6/72	5907558404159
03-016	250	0-50	5/30	5907558412215

Klucz nastawny z zapadką

Adjustable ratchet spanner / Verstellbarer Csanvarkulcs / Ключ разводной с храповым механизмом / Ключ плоскої з трітціоткою / Csanvarkulcs racsnis / Cheie reglabila cu clichet / Ключ наставительный с запоркой / Наставительный ключ с затком / Reguliuojamas raktas, žiūrys - / Regulijama atslęga ar fiksatoru / Reguleeritavan korigista viti / Гаечен ключ със запорка / Podesivajusni ključ s račnom / Francuski ključ / Ρυθμιζόμενα γαλλικά κλειδιά με οδοντωτό τροχό ανατολής / Llave inglesa con pestillo / Chiave a rullino con cricchetto / Chave inglesa com lingueta / Clé à cliquet à ouverture variable

- dzięki zastosowaniu przegubu, praca kluczem odpowiada pracy kluczem z grzechotką
- owing to its flex head design it can be operated as a ratcheted spanner
- благодаря шарниру работа с ключом похожа на работу с трещоткой

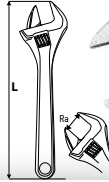

Ref.	L[mm]	Ra[mm]	Ø	EAN
03-017	0-30,5	200	0/36	5907558404326



Ref.	L[mm]	Ra[mm]	Ø	EAN
03-027	150	0 - 23	6/120	5907558426090
03-028	200	0 - 28	6/60	5907558426106
03-029	250	0 - 32	6/48	5907558426113



Ref.	L[mm]	Ra[mm]	Ø	EAN
03-023	155	0 - 28	6/72	5907558426052
03-024	205	0 - 32	6/72	5907558426069
03-025	256	0 - 43	6/36	5907558426076
03-026	306	0 - 53	6/36	5907558426083

Klucz nastawny krótki

Adjustable wrench / Schraubenschlüssel / Ключ разводной / Ключ разводный гаечный / Csanvarkulcs rövid / Cheie reglabila / Ключ регулируемый / Наставительный ключ / Francoski ključ / Reguliuojamas raktas / Bidačslęga / Tellitan viti / Разводжен гаечен ключ / Podesivi ključ / Francuski ključ / Γαλλικό κλειδί / Llave inglesa / Chiave a rullino / Chave regulável / Clef à ouverture réglable / Verstelbaar moersleutel

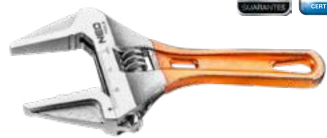
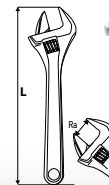

Ref.	L[mm]	Ra[mm]	Ø	EAN
03-019	118	0 - 28	6/72	5907558426014
03-020	139	0 - 32	6/72	5907558426021
03-021	156	0 - 43	6/36	5907558426038
03-022	185	0 - 53	6/36	5907558426045

Klucz do rur stillson

Stillson pipe wrench / Rohrschlüssel stillson / Ключ трубный stillson / Ключ трубный «Stillson» / Csőfogó, «Stillson» / Cheie reglabila pentru tevi / Klešiči trubkové Stillson / Ključ na rúry stillson / Ključ za cevi stillson / Raktas vamzdžiams „Stillson” / Саурулу атсга / Stillson-торувōти / Тръбен ключ stillson / Ključ za cijevi stillson / Ključ za cevi stillson / Σαλγκοκαθαράς τύπου Stillson / Llave stillson / Giratubi Stillson / Чеве р. Tubos stillson / Clef pour tubes stillson / Sleutel voor stillsonbuizen



Ref.	L[mm]	Ra[mm]	⊖	EAN
02-108	240	0-31	6/48	5907558434606



Ref.	L[mm]	Ra ["]	⊖	EAN
02-106	300/12"	1 3/8"	0/24	5907558434583
02-107	350/14"	2"	0/24	5907558434590

Szczypce do rur

Water pump pliers / Rohrzange / Клеуци трубные / Клеуци трубни / Vízpumpa fogó / Clește p/u pompa de apă / Klešiče na trubky / Hasák / Čevne klešče / Replės vamzdžiams / Rorstangos / Veepumba tangid / Клеуци Гагза / Kiješta rapige / Klesta paragraj / Γκαζοανάλια / Tenazas para tubos / Pinza regulabila de idraulico / Pinças p. Tubos / Pince pour tubes / Buistang

nastawny przegub ślizgowy, polerowane szczęki
adjustable slide joint, polished jaws



DIN 8976



Ref.	L[mm]	Ra[mm]	⊖	EAN
01-202	250	0-36	6/48	5907558434613

nastawny przegub zębatkowy
adjustable toothed joint

переставной коробчатый шарнир



Ref.	L[mm]	Ra[mm]	⊖	EAN
01-204	250	0-42	6/48	5907558412994

nastawny przegub zębatkowy, polerowane szczęki
adjustable toothed joint, polished jaws

переставной коробчатый шарнир, полированные губки



Ref.	L[mm]	Ra[mm]	⊖	EAN
01-200	240	0-31	6/48	5907558434606
01-203	300	0-46	6-24	5907558434620

Szczypce uniwersalne

Combination pliers / Kombizange / Пассатожу / Пасатожу / Kombinált fogó / Clește universal / Kombinované klešiče / Klešiče kombinované / Kombinirane klešiče / Universalios replės / Plakankaibles kombinētās / Universalnāpārsats / Клеуци комбинирани / Kombinirana kiješta / Kombinovana klešta / Πένια γενικής χρήσης / Alicates universales / Pinza universale / Pinças universais / Pince universelle / Universele tang



Ref.	L[mm]	⊖	EAN
01-010	160	6/48	5907558401547
01-011	180	6/48	5907558401554
01-012	200	6/48	5907558401561

Szczypce wydłużone wygięte

Long nose bent pliers / Zange lang, gebogen / Покосожуби удлиненные изогнутые / Щипци вудожжени, вужнати / Hajlított csőrű fogó / Cleste varf ascutit indoit / Klešiče prodložene vyhnuté / Klešiče predžné vyhnuté / Končaste klešiče - upognjene / Prailgintos replės, lenktos / Izliektas pagarinātas knaibles / Pikkade kõverate otstega näpitsad / Клеуци удължену изогнату / Izdužena savinuta kiješta / Izdužena uvijena klešta / Μυτασιμωδο κούρτο / Alicate Telefeno curvo / Pinza a becco curvo / Pinças curvas prolongadas / Pince allongée coudées / Lange gebogen tang

szczęki odgięte pod kątem 45° - ułatwienie chwytania małych części
jaws bent at 45° - easier gripping small parts
губки изогнутые под углом 45° - облегчают захват мелких деталей



Ref.	L[mm]	⊖	EAN
01-015	160	6/48	5907558401592
01-016	200	6/48	5907558401608

Szczypce płaskie

Flat nose pliers / Zange flach / Покосожуби / Щипци з плоскими зубками / Laposcsőrű fogó / Cleste varf plat / Klešiče ploché / Klešiče ploché / Ploščate klešiče / Ploščišios replės / Plakanas knaibles / Lamenāpārsad / Плоски клеуци / Plosnata kiješta / Ravna klešta / Πένια / Alicate Bocca plana / Pinza a becco piatto / Pinças planas / Pince à fourches / Vlakke tang



Ref.	L[mm]	⊖	EAN
01-019	160	6/48	5907558401639

Szczypce wydłużone proste

Combination pliers / Kombizange / Пассажирки / Пасатжирки / Hosszúcsőrű fogó / Clește universal / Kombinované klešče / Klešte kombinované / Kombinirane kleščice / Universaliος reples / Plakanknaibles kombinētās / Universaálnāpīstads / Клецки комбинарнe / Kombinirana klijesta / Kombinovana klesta / Пeвoа yвeлчeнaя чoпaчкa / Alicates universales / Pinza a becca lunga / Pinças retas prolongadas / Pince allongée droite / Lange rechte tang

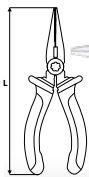

25 years GUARANTEE



DIN 5745

55-60 HRC

Ref.	L[mm]	⚙	EAN
01-013	160	6/48	5907558401578
01-014	200	6/48	5907558401585

Szczypce boczne

Diagonal cutting pliers / Seitenzange / Бокорезы / Бoкopизи / Oldalsípő fogó / Clește ascuțit diagonal de tăiat sîrmă / Vočni klešče / Cvikačky bočné / Stranske kleščice / Šonines reples / Sānknaibles / Diagonaal-lōiketangid / Клецки Рeзачки / Klijesta cvikerice / Klesta poluokruga / Πλαγιοκόπτεσ / Alicates diagonales / Tranchese laterale / Pinças laterais / Pince latérale / Zijtang

krawędzie cięcia hartowane indukcyjnie
induction hardened cutting edges
режущие кромки, закаленные индуктивным методом

25 years GUARANTEE



DIN 5749

55-60 HRC



Ref.	L[mm]	⚙	EAN
01-017	160	6/48	5907558401615
01-018	180	6/48	5907558401622

Szczypce okrągłe

Round nose pliers / Rundzange / Круглозубцы / Кpуглозуби / Kerekcsőrű fogó / Clește rotund / Kulatē klešče / Klešče s okružnou čelustou / Okrągłe kleščice / Apvaltos reples / Apatknaibles / Umarmokk-nāpīstads / Клецки Чoвкy / Klijesta okrugla / Klesta okrugla / Μυτατοίγμιο με στρογγυλά ράμφη / Alicates redondos / Pinza a becca tonda / Pinças redondas / Pince ronde / Ronde tang

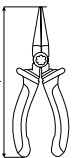

25 years GUARANTEE



DIN 5745

Ref.	L[mm]	⚙	EAN
01-020	160	6/48	5907558401646

Szczypce czółowe

End cutting pliers / Frontzange / Нyсачки торцовые / Щипцы торцевые / Homlokcsőrű fogó / Clește taieie frontală / Klešče čelni / Klešče čelne / Čelne kleščice / Kandikles / Kniebjamās knaibles / Otsnāpīstads / Клецки чeмy / Čeona klijesta / Čeona klešta / Tavālia / Alicate de corte frontal / Tenaglia / Pinças frontais / Pince frontale / Hoofdtang

wydłużona krawędź cięcia
elongated cutting edge
удлиненная режущая кромка

25 years GUARANTEE



55-60 HRC

DIN 5748

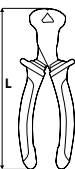

Ref.	L[mm]	⚙	EAN
01-021	160	6/48	5907558401653
01-022	200	6/48	5907558401660

Szczypce precyzyjne czółowe

Precision end cutter pliers / Stirnpřizisnizange / Нyсачки торцовые прецизионные / Бoкopизи прецизијни / Homlokcsőrű fogó / Clește frontal / Lklešče čelni jemná mechanika / Cvikačky čelne mikro / Stranske kleščice, precizne / Žnyplēs tiksliešis darbamš / Knaibles / Tāpīsnāpīstads otste lōikmāiseks / Клецки резачки / Klijesta cvikerice / Klesta secice / Εμπροσθοκόπτεσ ακριβείας / Alicates frontales de precisión / Tenaglia di precisione / Pinças precisas frontais / Pince de précision frontale / Precisie hoofdtang

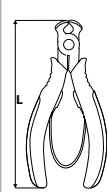

25 years GUARANTEE



Ref.	L[mm]	⚙	EAN
01-101	115	6/96	5907558401677

Szczypce precyzyjne wydłużone proste

Precise long nose straight pliers / Feinzange, lang, gerade / Плoскoзубцы прецизионные удлиненные / Щипцы прецизијни, з видoвoжeними, пpямими зyбкaми / Hosszúcsőrű fogó / Clește precizie-varf lung / Klešče precizni prodložene rovnē / Klešče precizne predžene rovnē / Precizne ravne podajšane kleščice / Prailgintos precizines reples, tiesios / Pagarinātās precizizjošās plakanknaibles / Pikkade otstega reppnāpīstads / Прецизиyи удoльжeны клeцки / Precizna izdužena jednostavna klijesta / Precizna ravna izdužena klešta / Μυτατοίγμιο ακριβείας / Alicate puntas redondos larga / Pinza di precisione a becca lunga / Pinças precisas prolongadas retas / Pince de précision allongée droite / Lange rechte precisie tang

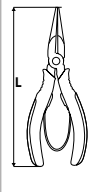

25 years GUARANTEE



Ref.	L[mm]	⚙	EAN
01-102	130	6/96	5907558401684

Szczypce precyzyjne wydłużone wygięte

Precise long nose bent pliers / Feinzange, lang, gebogen / Плoскoзубцы прецизионные удлиненные изогнутые / Щипцы прецизијни, з видoвoжeними, вигнутими зyбкaми / Rövüdsörű fogó / Clește precizie-varf indoți / Klešče precizni prodloženi vjhnute / Klešče precizne predžene vjhnute / Precizne podajšane upragnje kleščice / Prailgintos precizines reples, tiesios / Iziektas pagarinātās precizizjošās plakanknaibles / Pikkade kāvartate otstega reppnāpīstads / Прецизиyи удoльжeны изгнyтыи клeцки / Precizna izdužena savinuta klijesta / Precizna uvijena izdužena klešta / Μυτατοίγμιο ακριβείας κyρτoς / Alicates puntas curvas larga / Pinza di precisione a becca curva / Pinças precisas prolongadas curvadas / Pince de précision allongée coudées / Lange gebogen precisie tang

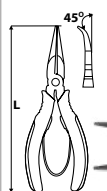

25 years GUARANTEE



Ref.	L[mm]	⚙	EAN
01-103	140	6/96	5907558401691

Szczypce precyzyjne płaskie

Precision flat pliers / Präzisionszange flach / Плоскогубцы прецизионные / Плоскогубці прецизійні
 płaski / Laposcsőrű fogó / Cleste plat / Kleště jemná mechanika / Klešte ploché mikro / Ploske klešče,
 precizne / Plokščios repls tiksliams darbam / Plakanknaibles / Tärpislametokk-närpissad / Клеуци
 човки / Klijesta plosnata / Klesta pljosnata / Παλαταίτιμο ακριβείας γενικής χρήσης / Pinza di precisione
 a becco piatto / Pinças precisas planas / Pince de précision à fourches / Precisie vlakke tang



Ref.	L[mm]	☞	EAN
01-105	130	6/96	5907558401714

Szczypce precyzyjne boczne

Precision diagonal pliers / Seitenpräzisionszange / Бокорезы прецизионные / Плоскогубці прецизійні
 діагональні / Oldalcsőrű fogó / Cleste diagonal / Kleště boční jemná mechanika / Cvikacky bočné mikro
 / Čelne klešče, precizne / Soninės repls tiksliams darbam / Sānknaibles / Diagonāl-tärpissnärpissad
 / Клеуци реэачни / Klijesta cvikerice / Klesta secice / Πλαγιοκόρτης ακριβείας / Alicates diagonales de
 precisión / Tranchese laterale di precisione / Pinças precisas laterais / Pince de précision latérale /
 Precisie zijtang



Ref.	L[mm]	☞	EAN
01-106	110	6/96	5907558401721

Szczypce blacharskie

Axial grip locking pliers / Klemmzange / Клеуци зажимные / Плоскогубці обтисниці / Patentfogó / Cleste fixator / Upínací kleště / Klešte fixačné univerzálné / Prijemne klešče / Uzspaidimo repls /
 Fiksátorstangas / Lukustustangid / Клеуци чиран / Stop klijesta / Smrt klesta / Πένσες - χγκρίν / Tenazas grip / Pinza griffante / Pinças para grampear / Pince de serrage / Krimptang



TYPE W
195 mm

Ref.	info	☞	EAN
11-020	W, max. 25 mm	1/20	5907558445473



TYPE L
195 mm

Ref.	info	☞	EAN
11-021	L, max. 57 mm	1/20	5907558445480



TYPE LL
205 mm

Ref.	info	☞	EAN
11-022	LL, max. 18 mm	1/20	5907558445497



TYPE J
210 mm

Ref.	info	☞	EAN
11-023	J, max. 25 mm	1/20	5907558445503



TYPE JJ
230 mm

Ref.	info	☞	EAN
11-024	JJ, max. 40 mm	1/20	5907558445510

Szczypce zaciskowe

Locking pliers / Klemmzange / Клещи зажимные / Пассоказуби обтисниці / Patentfogó / Clește fixator / Uprinaci klešče / Kliešte fixačné univerzálne / Prijemne klešče / Užspaidimo replės / Fiksatorstangas / Lukustustangid / Клещи Чирак / Stop Klijesta / Smrt klesta / Πέναξ - Γκρίν / Tenazas grip / Pinza a scatto dritta / Pinças para grampear / Pince de serrage / Krimp tang

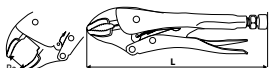

25 years GUARANTEED

TUV Rheinland CERTIFIED

CrV steel

CrMo steel



głowica ze stali CrMo
korpus ze stali CrV
CrMo steel head
CrV steel body
головка - сталь CrMo
корпус - сталь CrV

Ref.	L[mm]	Ra[mm]	⌘	EAN
01-216	250	0-47	6/36	5907558409185

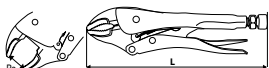

25 years GUARANTEED

TUV Rheinland CERTIFIED

CrV steel

CrMo steel



głowica ze stali CrMo
korpus ze stali CrV
CrMo steel head
CrV steel body
головка - сталь CrMo
корпус - сталь CrV

Ref.	L[mm]	Ra[mm]	⌘	EAN
01-217	250	0-45	6/36	5907558409192

Szczypce do pierścieni osadzczych

Circlip pliers / Zange für Stellringe / Щипцы для стопорных колец / Щипцы для стопорных шплицев / Zégergyűrű fogó / Set clește cu spirală / Klešče pro stavěcí kroužky / Segerky vonkajšie rovné / Klešče seger / Replės žiedams / Sprostagredzenu stangos / Vedrunāpīstads / Клещи Зеєр / Kružna Klijesta / Kružna klesta / Ασφαλιστηριακές / Alicates para anillos de asiento / Pinza per anelli elastici / Pinças p. Anéis / Pince pour bagues de retenue / Tang voor dopringen

zewnątrznie proste
external, straight tip
щипцы для внешних/прямые

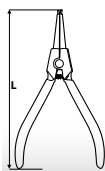

25 years GUARANTEED

TUV Rheinland CERTIFIED

CrV steel

Ref.	L[mm]	Ra[mm]	⌘	EAN
01-085	150	10-25	6/48	5907558440584
01-087	180	19-60	6/48	5907558440607
01-089	230	40-100	6/36	5907558440621

zewnątrznie wygięte
external, bent tip
щипцы для внешних/загнутые

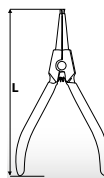

25 years GUARANTEED

TUV Rheinland CERTIFIED

CrV steel

Ref.	L[mm]	Ra[mm]	⌘	EAN
01-091	145	10-25	6/48	5907558440645
01-093	170	19-60	6/48	5907558440669
01-095	220	40-100	6/36	5907558440683

wewnętrzne proste
internal, straight tip
щипцы для внутренних/прямые

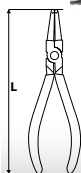

25 years GUARANTEED

TUV Rheinland CERTIFIED

CrV steel

Ref.	L[mm]	Ra[mm]	⌘	EAN
01-086	150	10-25	6/48	5907558440591
01-088	180	19-60	6/48	5907558440614
01-090	230	40-100	6/36	5907558440638

wewnętrzne wygięte
internal, bent tip
щипцы для внутренних/загнутые

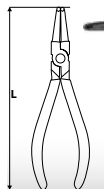

25 years GUARANTEED

TUV Rheinland CERTIFIED

CrV steel

Ref.	L[mm]	Ra[mm]	⌘	EAN
01-092	145	10-25	6/48	5907558440652
01-094	170	19-60	6/48	5907558440676
01-096	220	40-100	6/36	5907558440690

Automatyczny ściągacz izolacji

Automatic wire stripper / Automat. Abziehhzange / Съемник изоляции автоматический / Автоматичний стягачв ізоляції / Kábelcsupaszóló fogó / Clește automatic p/ri extragera izolatiei / Automatische stahovadko izolace / Kliešte odizolovacie automatické / Klešče za snemanje izolacije / Automatinis izoliacijos nuimtuvas / Stangas izoliācijas noņemšanai automatiskās / Automatischeis kaablitangid / Клещи Заослащива / Klijesta za izolaciju / Klesta za izolaciju / Αὐτομάτος απομωμητικός καλωδίων / Alicates pelacables automáticos / Pinza spela fili automatica / Apareho automático de remover isolação / Dénudeuse d'isolation automatique / Automatisch draadstriptang

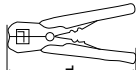

25 years GUARANTEED

TUV Rheinland CERTIFIED

22-10 AWG

52-60 HRC

52-57 HRC

01-500

01-540

Ref.	L[mm]	⌘	EAN
01-500	205	10/60	5907558403190
01-534	180	10/40	5907558439335
01-540	200	10/40	5907558454994



TUV Rheinland CERTIFIED

0.34-6.0 mm

195 mm

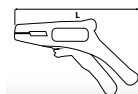

Ref.	L[mm]	⌘	EAN
01-519	195	10/60	5907558415599

NEO
TOOLS

NARZĘDZIA MECHANICZNE

MECHANICAL TOOLS

МЕХАНИЧЕСКИЕ ИНСТРУМЕНТЫ

Wkrętak płaski

Screwdriver slotted / Flachschraubendreher / Отвертка плоская / Відкрутка плоска / Csavarhúzó / Šurubelnířtá / Šurubelnířtá tip „Phillips“ / Šraubovák plochý / Skrutkovač plochý / Ploščati izvijáč / Ploščatis atsuktuvais / Skrugvriēzis / Skrugvriēzis krusta PH / Ristpeakruvikeeraja / Отвертка / Odvijáč / Odvijáč / Katašbiš etikonis / Destornillador plano / Giravite piatto / Chave de fenda plana / Tournevis à fourche / Vlakke schroevendraaier

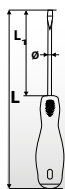

Ref.	⊖ [mm]	L[mm]	L ₁ [mm]	ø[mm]	⊞	EAN
04-011	3,0	150	75	3,0	12/240	5907558401745
04-012	4,0	180	100	4,0	12/240	5907558401752
04-013	5,5	205	100	5,0	12/120	5907558401769
04-014	5,5	310	200	5,0	12/144	5907558401776
04-001	6,5	100	38	6,0	12/288	5907558411638
04-002	6,5	240	125	6,0	12/144	5907558411645
04-015	6,5	270	150	6,0	12/144	5907558401783
04-003	8,0	275	150	8,0	12/120	5907558411652
04-016	8,0	325	200	8,0	12/120	5907558401790
04-004	10,0	325	200	9,5	6/96	5907558411669

Wkrętak krzyżowy PH

Screwdriver Phillips / Kreuzschraubendreher / Отвертка крестовая / Відкрутка крестовина / Csavarhúzó / Šurubelnířtá tip „Phillips“ / Šraubovák křížový / Skrutkovač kříž / Křížní izvijáč / Kryžminis atsuktuvais Phillips / Skrugvriēzis krusta PH / Ristpeakruvikeeraja / Отвертка / Odvijáč / Odvijáč / Katašbiš etikonis / Destornillador phillips / Giravite Phillips / Chave de fenda de cruzeta / Tournevis en croix / Kriusschroevendraaier

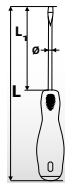

Ref.	⊕	L[mm]	L ₁ [mm]	ø[mm]	⊞	EAN
04-021	PH0	150	75	3	12/240	5907558401806
04-006	PH1	180	75	5	12/240	5907558411683
04-022	PH1	205	100	5	12/240	5907558401813
04-023	PH2	100	38	6	12/288	5907558401820
04-002	PH2	220	100	6	12/120	5907558401837
04-007	PH2	265	150	6	12/180	5907558411713
04-025	PH2	315	200	6	12/144	5907558401844
04-026	PH3	275	150	8	12/120	5907558401851

Wkrętak krzyżowy PZ

Screwdriver Pozidriv / Kreuzschraubendreher / Отвертка крестовая / Відкрутка крестовина / Csavarhúzó / Šurubelnířtá tip „Pozidriv“ / Šraubovák křížový / Skrutkovač kříž / Křížní izvijáč / Kryžminis atsuktuvais Phillips / Skrugvriēzis krusta PZ / Ristpeakruvikeeraja Pozidriv / Отвертка / Odvijáč / Odvijáč / Katašbiš etikonis / Destornillador phillips / Giravite Pozzi / Chave de fenda de cruzeta / Tournevis en croix / Kriusschroevendraaier

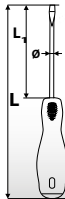

Ref.	⊕	L[mm]	L ₁ [mm]	ø[mm]	⊞	EAN
04-031	PZ0	150	75	3	12/600	5907558401868
04-032	PZ1	200	100	5	12/120	5907558401875
04-033	PZ2	100	38	6	12/288	5907558401882
04-034	PZ2	215	100	6	12/144	5907558401899
04-035	PZ2	320	200	6	12/144	5907558401905
04-036	PZ3	280	150	8	12/120	5907558401912

Wkrętak Torx

Torx screwdriver / Schraubendreher Torx / Отвертка Torx / Вкрутка «Torx» / Csavarhúzó torx / Šurubelnířtá varř Torx / Šraubovák Torx / Skrutkovač Torx / Izvijáč Torx / Atsuktuvais torcinis / Torx skrugvriēzis / Torx-kruvikeeraja / Отвертка Torx / Odvijáč Torx / Odvijáč Torx / Katašbiš Torx / Destornillador con punta torx / Giravite Torx / Chave de fenda Torx / Tournevis Torx / Torx schroevendraaier

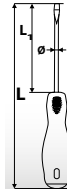

Ref.	⊕	L[mm]	L ₁ [mm]	ø[mm]	⊞	EAN
04-043	T10	205	100	5	12/120	5907558401929
04-044	T15	205	100	5	12/240	5907558401936
04-045	T20	205	100	5	12/240	5907558401943
04-046	T25	215	100	6	12/144	5907558401950
04-048	T30	215	100	6	12/144	5907558401974

Wkrętak płaski do pobijania

Slotted screwdriver go through / Schraubendreher, flach / Отвертка шлицевая ударная / Вкрутка плоская, ударная / Csavarhúzó kulcscsú hűhátó / Šurubelnířtá impact varř drept / Šraubovák plochý úderový / Sekací plochý skrutkovač / Ploščati izvijáč za zabijanje / Smáginis, ploščatis atsuktuvais / Plakanais skrugvriēzis / Lame löökkruvikeeraja / Отвертка плоская ударная / Plosnati odvijáč za nabijanje / Plosnati odvijáč za zabijanje / Katašbiš kroušis eninešo / Destornillador plano de golpe / Giravite passante piatto / Chave de fenda plano p. malhar / Tournevis à fourche à frapper / Vlakke slag Schroevendraaier

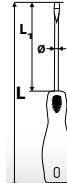

Ref.	⊖	L[mm]	L ₁ [mm]	ø[mm]	⊞	EAN
04-019	4,5	240	125	7,0	12/144	5907558403251
04-020	8,0	280	150	9,0	6/96	5907558403268

Wkrętak krzyżowy do pobijania

Screwdriver go through phillips / Kreuzschraubendreher zum Klopfen / Отвертка крестовая усиленная ударная / Відкрутка крестовина ударная / Csavarhúzó / Šurubelnířtá csucitilté p/ú sragere / Šraubovák křížový úderový / Skrutkovač křížový PHillips / Ploščati izvijáč, udarni / Kryžminis, smáginis atsuktuvais / Skrugvriēzis krusta PH stiena / Ristpeakruvikeeraja / Отвертка / Odvijáč / Odvijáč / Katašbiš etikonis / Destornillador de golpe phillips / Giravite passante Phillips / Chave de fenda de cruzeta p. malhar / Tournevis en croix à frapper / Slagkriusschroevendraaier

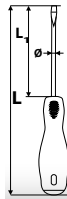

Ref.	⊕	L[mm]	L ₁ [mm]	ø[mm]	⊞	EAN
04-028	PH2	215	100	7	12/144	5907558403282

Wkrętaki do pobijania

Go through screwdrivers / Schraubendreher zum Aufheben / Отвертки ударные / Викруткі ударні / Csavarhúzó készlete / Surubelnita de impact / Šraubováký úderové / Sekacie skrutkovače / Izvijajući za zabijanje / Smítajúni sukutvai / Triecienskúvgriezti / Löökskrutkerajad / Ударні отвёртки / Odvijaci za nabijanje / Odvijanje / Катаβίβια κρούσης / Destornilladores de golpe / Set graviti passante / Chaves de fenda p. mathar / Tournevis à frapper / Slagschroevendraaiers



- 5.5 x 100 mm, 6.5 x 125 mm, 8 x 150 mm,
- PH1x75, PH2x100



Ref.	📦	EAN
04-240	12/24	5907558412857

Wkrętak odwracalny

Reversible screwdriver / Schraubendreher, umwendbar / Отвертка универсальная / Викруткі универсальна, з двобичними знімними наконечниками / Csavarhúzó készlet 2db marok / Surubelnitá cu varf dublu, reversibil / Šraubováký oboustranný / Otáčací skrutkovač / Dvosmerni izvijač / Atsuktuvus su keičiamais antgaliais / Universālais skrūvgrēzis / Pārārtava reaga krūvķerēja / Универсальная отвёртка / Povratni odvijač / Povratni odvijač / Катаβίβια γενικής χρήσης / Destornillador reversible / Giravite reversibile / Chave de fenda reversível / Tournevis réversible / Omkeerbare schroevendraaier



- 6x38 mm
- PH2x38 mm



Ref.	📦	EAN
04-201	12/144	5907558402230

Uchwyt do końcówek

Bit holder / Aufnahme für Spitzen / Зажим для наконечников / Тримач до наконечників / Befogászár bitekhez / Dispozitiv de prinderea capetelor / Skličidlo na nástavce / Upinadlo na nástavce / Vpenjalo za nastavke / Laikiklis antgaliams / Uzgaļu patrona / Otsakupadrin / Держач за наконечники / Drška za nastavke / Hvat za nastavke / Προσαρμογέας μπιτών / Mandril de sujeción para puntas / Innesto per inserti con impugnatura / Suporte de ponteiros / Manche pour embouts / Houder voor eindstukken

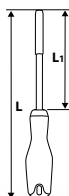

Ref.	L[mm]	L ₁ [mm]	📦	EAN
06-078	215	100	12/180	5907558414417

Wkrętaki

Screwdriver set / Schraubendreher / Отвертки / Відкруткі, набір / Csavarhúzó készlet / Set şurubelnije / Šraubováký / Súprava skrutkovačov-bity / Komplet izvijačev / Atsuktuvų komplektas / Skrūvgrēžu komplekts / Krūvķerēja komplekt / Отвёртки компл. / Odvijac set / Λυκόγιγ καταβίβιόν / Destornilladores / Set graviti / Chaves de fenda / Tournevis / Schroevendraaiers

- 5.5x75 mm, 6.5x100 mm
- PH1x75 mm, PH2x100 mm



Ref.	📦	EAN
04-204	6/36	5907558402254

- 4x250 mm, 5.5x250 mm
- PH1x250 mm, PH2x250 mm



Ref.	📦	EAN
04-214	6/24	5907558435627

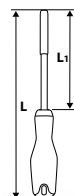

Ref.	L[mm]	📦	EAN
06-079	150	6/120	5907558430622

Wkrętaki

Screwdriver set / Schraubendreher / Οτσέρτικα / Βιδικρυτικά, набор / Csavarhúzó készlet / Set surubelnye / Šroubováky / Súprava skrútkovačov / Garnitura izvijačev / Atsukutvaj / Škrūvgriezu komplekts / Krivikeerajate komplekt / Οτσέρτικα κομπ. / Οδύνακι / Οδύνακι set / Συλλογή από κατασβίδια / Destornilladores / Set giraviti / Chaves de fenda / Tournevis / Schroevendraaiers



- ⊖ 8x150; 6.5x125; 5.5x100; 6.5x38 mm
- ⊕ PH2x125; PH1x100; PH0x75; H2x38 mm

Ref.	📦	EAN
04-207	6/12	5907558422177



Ref.	📦	EAN
04-213	6/24	5907558432220



- ⊖ 6.5x150; 6.5x125; 5.5x100; 3x75 mm
- ⊕ PH2x125; PH1x100; PH0x75 mm

Ref.	📦	EAN
04-206	6/24	5907558422214



- ⊖ 6.5x150; 5.5x100; 3x75; 5.5x38; 6.5x38 mm
- ⊕ PH2x150; PH1x100; PH0x75; PH2x38 mm

Ref.	📦	EAN
04-208	6/12	5907558422221



- ⊖ 8x150; 6.5x100; 5.5x75; 6.5x38; 2.5x40; 3.0x40 mm
- ⊕ PH3x150; PH2x100; PH1x75; PH2x38; PH0x40; PH0x40 mm
- ⊕ T5x40; T6x40; T7x40; T8x40 mm

- ⊖ 4; 5; 6 mm, PH1; PH2; PH3; PZ0; PZ1; PZ2; PZ3; T10; T15; T20; T25; T30; T40; H3; H4; H5; H6

Ref.	📦	EAN
04-210	5/10	5907558422160

Wkrętak z giętkim groszem

Screwdriver with flexible shank with flex. Spitze / Schraubendreher mit flex. Spitze / Οτσέρτικα с гнѳким стержнем / Βιδικρυτικά з жѳалом на шарѳипи / Csavarhúzó készlet flexibilis szárral / Šurubelnjaki set carp flexibil cu viř / Šroubovák s pružným hrotem / Skrútkovačov Flexi-Bity / Izvijači s pregibno konico / Atsukutvas su lankšćia šerdimi / Škrūvgriezu ar lokano galu uzgaljē / Paināvlva ķēpēdēmeņa krivikeeraja / Οτσέρτικα с Ηακρᾳίηηιμᾳ / Οδύνακι / Κατασβίδια με εύκαμπτη λαβή και set πᾳτων / Destornillador con vástagο flexible + puntas / Cacciavite con la punta flessibile / Chave de fenda com ponta flexivel / Tournevis à pointe douce / Schroevendraaier met zachte eindstuk

- ⊖ 5, 6, 7 mm
- ⊕ PH1, PH2, PH3, PZ1, PZ2
- ⊕ T15, T20



Ref.	📦	EAN
04-212	6/36	5907558402261

Wkrętaki

Screwdriver set / Schraubendreher / Отвертки / Відкрутки, набір / Csavarhúzó készlet / Set şurubluje / Šroubováky / Súprava skrutkovačov / Garnitura izvijačev / Atsukutvaj / Skrivgriežu komplekts / Krivikeerajate komplekt / Отвертки компл. / Odvijaci / Odvijac set / Συλλογή από καταβίδες / Destornilladores / Set giraviti / Chaves de fenda / Tournevis / Schroevendraaiers

- ⊖ 8x150; 6.5x125; 5.5x100; 3x75; 2.5x50; 3.0x50 mm
- ⊕ PH2x125; PH1x75; PH00x50; PH0x50 mm
- ⊖ T6x50; T7x50; T8x50 mm



4; 5; 6mm;
PH1; PH2; PH3;
PZ1; PZ2; PZ3;
T10; T15; T20; T25;
H4; H5; H6



Ref.	⊖	EAN
04-209	5/10	5907558422207



- ⊖ 6.5x125; 5.5x100; 6.5x38; 2.5x50; 2.0x50 mm
- ⊕ PH2x125; PH2x100; PH1x75; PH2x38; PH00x50; PH0x50 mm
- ⊖ T5x50; T6x50; T7x50; T8x50; T9x50; T10x50 mm

3; 3; 4; 4; 5; 5; 6; 6 mm

PH0; PH0; PH1; PH1; PH2; PH2;
PH3; PH3; T10; T10; T15; T20; T20; T25; T25; T27; T27; T30; T30;
H2; H2; H2.5; H2.5; H3; H3; H4; H4; H5; H5; H6; H6



Ref.	⊖	EAN
04-211	6/12	5907558422191



Końcówki wkrętakowe

Driver bits / Einsätze für Schraubendreher / Насадки / Наконечники викруток / Csavarhúzó betétek / Set biti / Šroubovákové nástavce / Skrutkovačie nástavce / Nastavki za izvijače / Atsukutvo antgajai / Skrivgriežu uzgaji / Krivikeerajatsakud / Накрайници за отвертка / Nastavci za odvijac / Nastavci za odvijac / Καταβιδόμετες / Puntas destornilladoras / Inserti per avvitare / Ponteiros chave de fenda / Embouts de tournevis / Schroevendraaierdstukken



Ref.	T	L[mm]	⊖	EAN
10-920	30	30	50/200	5907558452785
10-922	40	30	50/200	5907558452792
10-924	45	30	50/200	5907558452808
10-926	50	30	50/200	5907558452815
10-928	55	30	50/200	5907558452822
10-940	30	75	30/120	5907558452839
10-942	40	75	30/120	5907558452846
10-944	45	75	30/120	5907558452853
10-946	50	75	30/120	5907558452860
10-948	55	75	30/120	5907558452877
10-960	100	75	20/40	5907558452945

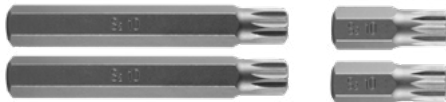

Ref.	M	L[mm]	⊖	EAN
10-900	8	30	50/200	5907558452723
10-902	10	30	50/200	5907558452730
10-904	12	30	50/200	5907558452747
10-906	8	75	30/120	5907558452754
10-908	10	75	30/120	5907558452761
10-910	12	75	30/120	5907558452778



Ref.	H	L[mm]	⊖	EAN
10-970	5	30	50/200	5907558452884
10-972	6	30	50/200	5907558452891
10-978	12	30	50/200	5907558452907
10-980	5	75	30/120	5907558452914
10-982	6	75	30/120	5907558452921
10-988	12	75	30/120	5907558452938

- ⊖ 30 mm: T20, T25, T30, T40, T45, T50, T55
- ⊖ 75 mm: T20, T25, T30, T40, T45, T50, T55
- ⊖ 30 mm: H4, H5, H6, H7, H8, H10, H12
- ⊖ 75 mm: H4, H5, H6, H7, H8, H10, H12
- ⊖ 30 mm: M5, 6, 8, 10, 12
- ⊖ 75 mm: M5, 6, 8, 10, 12

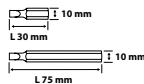

Ref.	⊖	EAN
06-107	0/10	5907558414424

Miara zwijana

Pocket rule / Wickelmessband / Pymetka / Pymetka / Acél mérőszalag / Ruletă de măsurat / Měřilo svinovací / Meter rolovací / Meter / Rulete plienine / Měřlenté rulete / Taskujoonlaud / Panemka / Metar / Metar / Μεταρρόλερ μετρητική ταινία / Flexómetro / Flessometro / Medidor enrolado / Mesure enroulée / Rolmaat



Ref.	L [m]	W [mm]	⊗	EAN
67-183	3	19	12/120	5907558425598
67-185	5	25	6/60	5907558425604
67-188	8	25	6/48	5907558425611

Suwmiarka

Caliper / Messschieber / Штангенциркуль / Штангенциркуль / Tolómér, rozsdamentes / Suport / Posuvné měřítko / Meradlo posuvné / Pomócno mērito / Slankmatis / Bīdmērs / Mōtesirkel / Шубнер / Pomócno mērito / Pomócno mērito / Αναλογικό παχύμετρο / Calibre / Calibro / Calibrador de corrediça / Pied à coulisse / Schufmaat

wykonana ze stali nierdziejnej hartowanej
wysoce precyzyjny noniusz wykonany z jednego kawałka stali nierdziejnej (bez łączeni i śrub)

made of hardened, stainless steel
high precision nonius made of single stainless steel piece (with no joinings or screws)

из закаленной нержавеющей стали
очень точный нониус из литой стали (без соединений и болтов)

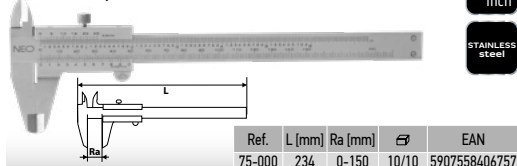

Ref.	L [mm]	Ra [mm]	⊗	EAN
75-000	234	0-150	10/10	5907558406757



suwmiarka z dokumentem potwierdzającym zgodność z normą DIN 862

bardzo wysoka precyza zapewniona dzięki noniuszowi wykonanego z jednego kawałka stali nierdziejnej bez łączeni i śrub
caliper with document of conformity with DIN 862 standard

high precision thanks to vernier made of one stainless steel piece without joins or screws
штангенциркуль с сертификатом, подтверждающим соответствие стандарту DIN 862
высокая точность обеспечена цельным стальным нониусом без винтов и соединений

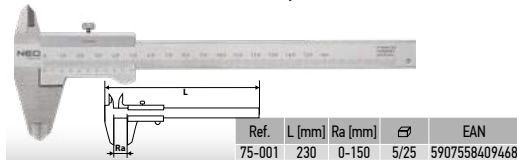

Ref.	L [mm]	Ra [mm]	⊗	EAN
75-001	230	0-150	5/25	5907558409488

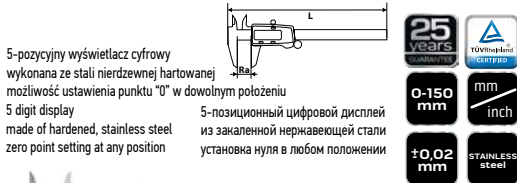

5-pozycyjny wyświetlacz cyfrowy
wykonana ze stali nierdziejnej hartowanej
możliwość ustawienia punktu "0" w dowolnym położeniu
5 digit display

made of hardened, stainless steel
zero point setting at any position

5-позиционный цифровой дисплей
из закаленной нержавеющей стали
установка нуля в любом положении

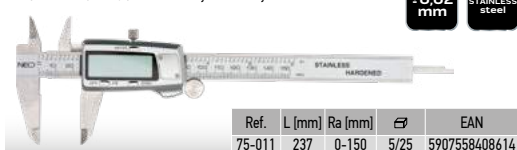

Ref.	L [mm]	Ra [mm]	⊗	EAN
75-011	237	0-150	5/25	5907558408614

Szczelinomierz

Feeler gauge / Schiebelehre / Шыл / Шыл / Hégzagmérő készlet / Calibru măsurare grosime / Spårómér / Listkové mierzky / Kontrolni lističi / Ertmių matavimo prietaisai / Spraugmērs / Mōtesond / Лубомер / Kontrolni lističi / Kontrolni lističi / Διακενόμετρο / Calibre de espesores / Calibro a spessori / Medidor de folgas / Jauge d'épaisseur / Voelmaat



Ref.	Ra [mm]	N	⊗	EAN
11-190	0.04 - 0.63	26	20/120	5907558452433
11-191	0.05 - 1.0	20	20/120	5907558452440
11-192	0.127 - 0.508	16	20/120	5907558452457

Miara składana

Wooden folding rule / Zollstock / Линејка складна / Линејка складна, дрвенна / Fatécse jehér-sárga / Metru pliant lemn / Skládaci metr / Meter skládaci / Zložljivi leseni meter / Medinis metras, sulankstamas / Metramērs saliekams / Kokkukallis joonlaud / Memsp / Drveni meter / Metar / Σύλινο πτυσσόμενο μέτρο / Metro plegable de madera / Metro pieghevale in legno / Medidor dobrável / Mesure articulée / Vouwmeter

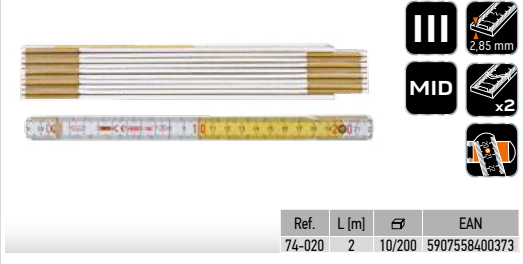

Ref.	L [m]	⊗	EAN
74-020	2	10/200	5907558400373

Miernik elektroniczny

Universal multimeter / Elektronikmessgerät / Мультиметр цифровой / Тестер универсальный / Multiméter univerzális / Multimetro universal / Elektronický měřicí přístroj / Univerzálny multimeter / Elektronski multimeter / Universalis el. matuoklis / Multimētrs universāls / Univerzaalne multimeter / Мультицетер / Univerzalni multimeter / Univerzalni multimeter / Ηλεκτρονικός μετρητής γενικής χρήσης / Multímetro digital / Misuratore universale / Medidor eletrônico / Appareil de mesure électronique / Elektronischer meter



DC V	200mV/2V/20V/200V/300V	Ref.	⊗	EAN
AC V	2V/20V/200V/300V			
DC A	200µA/2000µA/20mA/200mA/2A/10A	74-001	0/26	5907558409154
AC A	200µA/2000µA/20mA/200mA/2A/10A			
Ω	200Ω/2kΩ/20kΩ/2MΩ/20MΩ			
T °C	-20 - 1000 °C			
HF F	20nF - 100µF			

Miernik cęgowy

Digital clamp meter / Messgerät / Клещи электроизмерительные / Клещи струмоизмерительные / Multiméter digitális / Multiméter digitális lakatfogó / Klešťový měřicí přístroj / Klešťový merací prístroj / Tokovne klešče / Matavimo replės / Strāvas aizsargājamais / Mēģētāngā / Електроизмерительные клещи / Mjerač za klijesta / Univerzalni multimetar / Амперотомитель / Pinza ampimétrica / Misuratore di voltaggio digitale / Medidor de alicates / Appareil de mesure électrique à pince / Stroamtang



Data hold function

Synthetic leather bag

Auto Range

LCD 3999

DC V	400mV/4V/40V/400V/600V
AC V	400mV/4V/40V/400V/600V
DC A	400A/600A
AC A	400A/600A
Ω	400Ω/4kΩ/40kΩ/400kΩ/4MΩ/40MΩ

Ref.	Q/26	EAN
94-003		5907558407662

Imadło

Vice / Schraubstock / Тучку / Лещата / Satu, forgatható / Menghinő / Svěrák / Zverák liatinový / Primež / Spaustuvas / Kalts / Krustangstang / Мензена / Радониčka stega / Mengele / Мёувен / Tornillo de banco de precisión / Morsa girevole / Torno / Etai / Breekijzer

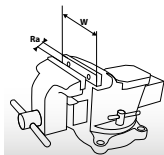
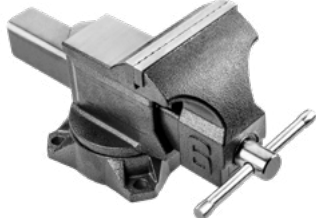

Ref.	W [mm]	Ra [mm]	m [kg]	Q	EAN
35-010	100	108	7,3	0/2	5907558400762
35-012	125	124	11,2	0/2	5907558400779
35-015	150	147	15,4	0/1	5907558400786

Łom

Wrecking bar / Brecheisen / Лом / Лом / Feszítővas / Rangó / Montage / Páçialo / Páçialo / Žebřarska babica / Laužuvas / Lauznis / Kang / Козу шрак / Poluga za čavle / Pajser / Λοστός / Palanca / Barra da demolição / Pé-de-cabra / Pied-de-biche / Breekijzer



Ref.	L [mm]	Q	EAN
29-041	400	0/5	5907558409529
29-092	1000	1/5	5907558409536



Ref.	L [mm]	Q	EAN
29-061	600	0/5	5907558407310
29-091	900	5/5	5907558407327

Młotek ślusarski

Machinist hammer / Schlosserhammer / Молоток столярный / Молоток слесарный / Kalarács, kőris nyél / Zámečnícké kladivo / Kladivo zámočnícké / Klijčavčičnik kladivo / Plaktkaus šaltkalviui / Åmurs atslédznika / Lukksephaamer / Чук / Bravoski čekić / Čekic / Σαούρι μεταλλοτεχνίτη / Martillo de cerrajerо / Martello da meccanico / Martelo p. Favos / Martele de serrurier / Slijphamer

- trzonek z drewna jesionowego
- obuch odkuty i hartowany indukcyjnie
- mocowanie obucha klinem stalowym
- handle made of ash wood
- induction hardened forged head
- head fixed by steel wedge



- rukoятка из ясеневой древесины
- головка кованая, закаленная индуктивным методом
- крепление головки стальным клином

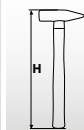
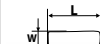

Ref.	m [g]	H [mm]	L [mm]	W [mm]	Q	EAN
25-010	100	258	82	17	0/10	5907558400410
25-012	200	280	95	19	0/10	5907558400416
25-013	300	300	105	23	0/10	5907558400427
25-014	400	310	110	26	0/10	5907558400431
25-015	500	315	118	29	0/10	5907558400474
25-018	800	345	130	35	0/10	5907558400441
25-020	1000	355	135	35	0/10	5907558400458
25-025	1500	378	145	42	0/6	5907558400465
25-030	2000	395	155	45	0/6	5907558400472

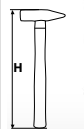

Ref.	m [g]	H [mm]	L [mm]	W [mm]	Q	EAN
25-083	300	300	105	23	6/36	5907558440188
25-085	500	320	118	27	6/36	5907558440195
25-088	800	350	130	33	6/24	5907558440201
25-090	1000	360	135	36	6/12	5907558440218



Hickory WOOD



fiberglass HANDLE



Ref.	m [g]	H [mm]	L [mm]	W [mm]	Q	EAN
25-143	300	295	103	23	6/24	5907558448368
25-144	400	300	110	25	6/24	5907558448375
25-145	500	322	115	25	6/24	5907558448382
25-146	800	355	130	33	6/12	5907558448399
25-147	1000	358	131	35	6/12	5907558448405
25-148	1500	410	141	40	4/8	5907558448412
25-149	2000	412	150	45	4/8	5907558448429



fiberglass HANDLE

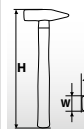

Ref.	m [kg]	H [mm]	L [mm]	W [mm]	Q	EAN
25-151	3	865	160	55	1/6	5907558448436
25-152	4	870	175	60	1/4	5907558448443
25-153	5	875	185	66	1/4	5907558448450
25-154	6	880	195	70	1/2	5907558448467
25-155	8	890	210	80	1/2	5907558448474
25-157	10	895	225	85	1/2	5907558448481

NEO
TOOLS

NARZĘDZIA MECHANICZNE

MECHANICAL TOOLS

МЕХАНИЧЕСКИЕ ИНСТРУМЕНТЫ

Młotek blacharski

Rubber mallet / Klempnerhammer / Молоток жёстяница / Молоток гумовой, стюарний / Karosszérialakatos kalapács / Cioacan de cauciuc / Klempnišké kladívko / Kladivo gumové / Kleparsko kladivo / Skardíninko plaktukas / Ámurs skárdnieka / Kumpnihammer / Чун зумен / Gumeni čekić / Cekić / Ματσάλο / Maza de hojalatero / Martello di lattioniere / Martelo p. chapas / Martelet de tôlier / Plaathamer

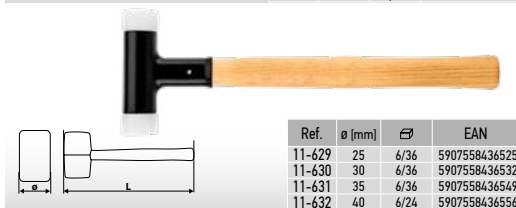
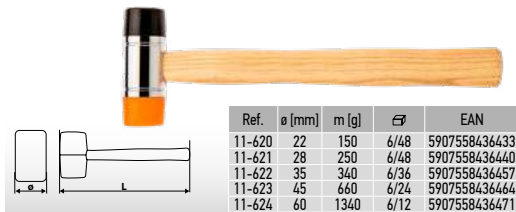

Cu Pu AL Fe NYLON



Zestaw blacharski

Tinsmith kit / Klempner-Set / Набор жёстяница / Набор бляхарский / Karosszérialakatos készlet / Set de tnichigerie / Klempnišká sada / Klampniarska súprava / Komplet za klepanje / Kompletas skardíninku / Skárdnieka komplekts / Plekkseparakomplekt / Тенечейжыцкі комплект / Limarski set / Komplet lima / Set λευκοαιδηροουργού / Juego de herramientas para hojalatería / Kit carrozeria / Kit p. chapa / Jeu d'outils de tôlier / Blikaplattset



Nożyce do prętów

Mini bolt cutter / Stabschere / Ножницы для проволоки / Ножки для дроту / Csapszegvágó / Scule tăiere minişeruburi / Blokové nůžky / Strihač svornikov / Škarje za žico / Mini žirkles armatürar / Skrüvjökki mini / Poldilöikur (váike) / Ножница за арматура / Škarje za armaturu / Makaze za armaturu / Μίνι μπουλοκοκόφτης / Cortavarillas / Tronchese / Tesoura p. Vergas / Cisaille à fers plats / Scharen voor stangen

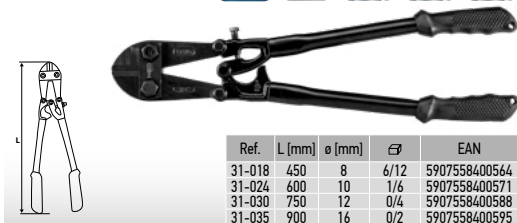

Nożyce do blachy

Tin snip / Blechscherer / Ножницы по жести / Ножкици по листовому металу / Lemezolló / Foarfecă tăiere tablă / Nůžky na plech / Nožnice na plech / Škarje za pločevino / Žirkles skardar / Grieznes skårdarm / Plekikäärid / Ножница за ламарина / Škare za lim / Makaze za lim / Χαλίδι λαμαρινάς / Tijeras corta chapa / Cesoia / Tesoura para chapa / Cisaille coupe-tôle / Blikscharen



Pilnik do metalu

Steel file / Metallfeile / Напильник по металлу / Пилыньк по металу / Reszeló lapos / Tűtőtare metal / Pilnik na kov / Pilnik polkruhový / Konica za kovino / Dildé metáului / Vile metáloom / Terasviil / Puna / Turpija za metal / Turpije za metal / Λίμα για μέταλλο / Lima para metal / Lima per acciaio / Lima para metal / Lime à métal / Metaalvijl



Ref.	L [mm]	☞	☞	EAN
37-022	200/2	□	10/80	5907558400847
37-122	200/2	□	10/80	5907558400939
37-222	200/2	□	10/80	5907558401028
37-322	200/2	□	10/80	5907558401110
37-422	200/2	△	10/80	5907558401202



Ref.	L [mm]	☞	EAN
37-605	200	4/16	5907558407426



Ref.	L [mm]	☞	EAN
37-610	200	4/16	5907558407433

Ścisk stolarski

F-clamp / Schraubzwinge / Струбцина столярная / Струбцина столярная / Byorsszorító, racsnis / Clemă în forma F / Truhlářská svorka / Zvierka stolárska / Mizarska sprona / Spausstavus staliui / Spīles galdnieka / F-klamber / Стяга / Stolarska stega / Stolarska stega / Ξυζυγκτῆρας Ξυλοσυρού / Sargento / Morsetto a F / Grampa de marcenaria / Serre-joint de menuisier / Timmermansklennen



Ref.	L [mm]	☞	EAN
45-220	200x120	2/6	5907558435481
45-230	300x120	2/6	5907558435498
45-240	400x120	2/6	5907558435504

Piła do metalu

Hacksaw / Metallsäge / Ножовка по металлу / Ножовка по металлу / Fémfűrész / Ferástráru pentru metal / Pila na kov / Pilka na kov / Žaga za kovino / Metalo pišklas / Žagis metáloom / Metallisaaq / Τρυπήν za metal / Pila za metal / Testera za metal / Πριόνι μετάλλου / Sierra para metal / Lama per sega ad arco / Serra para metal / Scie à métal / Zaag voor metaal

- innowacyjny system 3D, umożliwiający obracanie pałki i przecinanie elementów w miejscach, gdzie dostęp jest utrudniony lub wręcz niemożliwy
- innovative 3D system enables rotation of the bow and cutting elements at places, which are hard or even impossible to access
- инновационная система 3D, позволяющая работать в труднодоступных местах

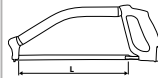

Ref.	L [mm]	☞	EAN
43-300	300	6/36	5907558401387

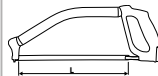

Ref.	L [mm]	☞	EAN
43-301	300	10/20	5907558447149

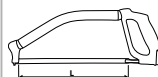

Ref.	L [mm]	☞	EAN
43-302	300	12/24	5907558447156

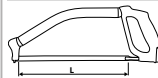

Ref.	L [mm]	☞	EAN
43-310	150	10/60	5907558447163

NEO
TOOLS

NARZĘDZIA MECHANICZNE

MECHANICAL TOOLS

МЕХАНИЧЕСКИЕ ИНСТРУМЕНТЫ

Uchwyt do brzeszczoty

Hackasaw blade holder / Sägeblatthalterung / Держатель для / полотно ножовки / Затиснак до полотна / ножовки / Fémfűrés / Fixator pínáz feresztrú / Držák ostří / Držiak pilových plátkov / Vpenjalo za rezilo / Rankena ošmenims / Ząga asmera turētājs / Raussaelehe hoidik / Držac testere za metal / Λάμα για αβρονόπλοια / Mango para hoja de sierra / Manico per lama / Suporte do lâmina / Monture à lame de scie / Mesbladhouder

300 mm BI-MATERIAL HANDLE



Ref.	L [mm]	⊖	EAN
43-320	300	12/96	5907558447170

Przecinak

Chisel / Meißel / Зубило / Зубило / Laposvágó / Daltű / Sekác / Sekáč / Dleto / Kírstukas / Cirtinis / Auguraud / Секач / Rezac / Sekáč / Σμίλη / Cortafrio / Scalpello / Cortador / Burin / Beitel

TUVHARD certified CrV steel

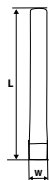

Ref.	L [mm]	⊖ [mm]	⊖	EAN
33-072	150	10	10/200	5907558413304
33-073	150	13	10/200	5907558413311
33-074	150	16	10/100	5907558413328

Punktak

Centre punch / Körner / Кернер / Кернер / Pontozó / Punctator / Důlčák / Raznik / Točkalo / Zymeklis / Punksitis / Augumārgisti / Керна / Ručni bušać / Obeleživač / Pónva aidiþrou / Punzón centrador / Punzone tondo / Punção / Pointeau / Doorslag

TUVHARD certified CrV steel

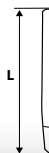

Ref.	L [mm]	⊖ [mm]	⊖	EAN
33-063	120	6	10/200	5907558413229
33-064	120	8	10/200	5907558413236

Wybijak

Pin punch / Austreiber / Зубило / Βυβισιασ / Stiftkiütő / Matritza de perforat / Vyrážec / Vyrážac / Izbijac / Zymeklis (iskalimui) / Puansons / Auguraud / Βυβισιασ / Izbijac / Izbijac, prosekac / Σμίλη / Punzón / Punzone a punta / Chasse-goupille / Puntslag

TUVHARD certified CrV steel

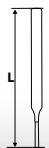

Ref.	L [mm]	⊖ [mm]	⊖	EAN
33-066	150	3	100/200	5907558413250
33-067	150	4	100/200	5907558413267
33-068	150	5	100/200	5907558413274
33-069	150	6	100/200	5907558413281

Zestaw wybijaków i przecinaków

Pin punch and chisel set / Austreiber- und Meißel-Set / Набор пинсонов и зубил / Набор зубил / Véső és kiütő készlet / Set de poansoane și daltii / Sada vyrážeců a sekáčů / Súprava priebojnikov a sekačov / Komplet izbijaciev in dlet / Kalimo kalju ir kirstuku rinkinys / Cilju spiedņu un cirtņu komplekts / Tornide ja meislite komplekt / Комплект пинсонов и секачей / Set izbijaca i rezaca / Komplet izbijaca i sekača / Set ζυμπάδων και αμιλιών / Juego de punzones y cortadores / Punzoni e scalpelli / Kit de mnadrís e cortadores / Jeu de chasse-goupilles et de burins / Set van puntslagen en knippers

TUVHARD certified

CrMo steel

x5



- wybijak 4x9,50 mm
- przecinak płaski 12x9,5 mm
- przecinak krzywowy 5x9,5 mm
- dobijak 3x9,5 mm
- punktak 4x9,5 mm
- pin punch 4x9,50 mm
- cold chisel 12x9,5 mm
- centre chisel 5x9,5 mm
- taper punch 3x9,5 mm
- centre punch 4x9,5 mm
- пробойник 4x9,50 мм
- зубило плоское 12x9,5 мм
- зубило лина 5x9,5 мм
- бородок 3x9,5 мм
- кернер 4x9,5 мм

Ref.	⊖	EAN
33-060	10/40	5907558407457

TUVHARD certified

CrV steel

x6



Ref.	⊖	EAN
33-061	6/36	5907558413205

TUVHARD certified

CrV steel

x12



Ref.	⊖	EAN
33-062	6/12	5907558413212

Mikropalnik

Microtorch / Mikrobrënnner / Микрогорелка / Мініпаяльннк / Forrasztókészülék piezo, tölthető / Microinjector / Mikrohořák / Mikro pajkovačka / Gorálnik / Mikro degiklis / Lodlampa mini / Mikroelektrólamp / Горелка мнкро / Mikro Plinska lemilica / Mikro gasna lemilica / Флаγοποτ / Microsoplete / Micro bruciatori / Mikromaçarica / Micro-brûler / Microbrander

w zestawie końcówka lutownicza
zapłon piezo
blokada włącznika
możliwość regulacji wielkości płomienia

soldering tip included
piezo ignition
microtorch features safety lock
adjustable flame size

в наборе паяльная насадка
пьезозажигание
блокиратор кнопки включения
регулировка пламени



Ref.	L [mm]	⊞	EAN
19-901	170	10/60	5907558409000

Palnik gazowy

Gas torch / Gasbrenner / Горелка газовая / Паяльник газовой / Forrasztókészülék / Arzator / Plynový hořák / Horáko / Plinski gorálnik / Dujinis degiklis / Gázes deglis lodlampa / Gaspiñeleti / Горелка / Plamenik / Gasna lemilica / Καυστήρας υγραερίου / Equipo para soldar / Bruciatore a gas / Maçarica de gás / Chalumeau à gaz / Gasbrander



Ref.	⊞	EAN
20-025	10/100	5907558449648

Nabój z gazem butan

Butane gas cartridge / Butan-Gas-Patrone / Баллон с газом бутан / Балончик з газом бутан / Bután gázipatron / Cartuş cu gaz butan / Kartuşe s plnmem butan / Butánová kartuša / Jeklenka s plinom butan / Butano dujų balionas / Balons ar butāna gāzi / Butaan-gaasipadron / Бутылка с аз бутан / Patróna sa butan plinom / Patróna sa butan gasom / Δοχείο με υερία Βουτανίου / Cartucho de gas butano / Cartuccia di gas butano / Cartuxo com gás / Cartouche avec gaz butane / Butaan vervangcartridge /

227 g



Ref.	⊞	EAN
20-030	4/28	5907558449655

Nitownica

Riveter / Nietmaschine / Заклепочник / Klepальный инструмент / Popszegeshűző / Mašina de nituri / Nyjtovačka / Kliešte nitovace ocelové / Pištola za kovičenje / Kniediklis / Kniežu stangas / Needitangid / Нитачка / Klijesta za zakovice / Pistolja za pop nitne / Hlači / Remachadora / Rivettatrice / Rebitadora / Rivuse / Klinknagelmachine

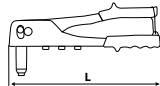

- Steel Ø 2,4/3,0/3,2/4,0/4,8/5,0 mm
- Cu Ø 2,4/3,0/3,2/4,0/4,8/5,0 mm
- Al Ø 2,4/3,0/3,2/4,0/4,8/5,0 mm
- Ø 2,4/3,0/3,2/4,0 mm

Ref.	Ø [mm]	L [mm]	⊞	EAN
18-101	2,4/3,2/4,0/4,8	264	10/30	5907558400137

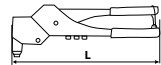

- Steel Ø 2,4/3,0/3,2 mm
- Cu Ø 2,4/3,0/3,2 mm
- Al Ø 2,4/3,0/3,2/4,0/4,8/5,0 mm
- Ø 2,4 mm

Ref.	Ø [mm]	L [mm]	⊞	EAN
18-102	2,4/3,2/4,0/4,8	280	10/20	5907558400144

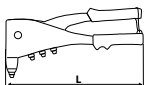

- Steel Ø 2,4/3,0/3,2/4,0/4,8/5,0 mm
- Cu Ø 2,4/3,0/3,2/4,0/4,8/5,0 mm
- Al Ø 2,4/3,0/3,2/4,0/4,8/5,0 mm
- Ø 2,4/3,0/3,2/4,0/4,8/5,0 mm

Ref.	Ø [mm]	L [mm]	⊞	EAN
18-103	2,4/3,2/4,0/4,8	265	10/30	5907558405811

Nitownica

Riveter / Nietmaschine / Заклепочник / Клепальный инструмент / Popszegecszűző / Mašina de nituit / Nýtovačka / Kliešte nitovacie oceleové / Pištola za kovičenje / Kniediklis / Kniezu stangas / Needitangid / Humtacka / Klijesta za zakovice / Pistolj za pop nitne / Нюл / Remachadora / Rivettatrice / Rebitadora / Riveuse / Klinknagelmachine

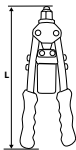

- Ø 2,4/3,0/3,2/4,0/4,8 mm
- Ø 2,4/3,0/3,2/4,0/4,8 mm
- Ø 2,4/3,0/3,2/4,0/4,8 mm
- Ø 2,4/3,0/3,2/4,0/4,8 mm

Ref.	Ø [mm]	L [mm]	Ø	EAN
18-107	2,4/3,2/4,0/4,8	275	6/24	5907558413564



- Ø 2,4/3,0/3,2/4,0/4,8/5,0/6,0/6,4 mm
- Ø 2,4/3,0/3,2/4,0/4,8/5,0/6,0/6,4 mm
- Ø 2,4/3,0/3,2/4,0/4,8/5,0/6,0/6,4 mm
- Ø 2,4/3,0/3,2/4,0/4,8/5,0/6,0/6,4 mm

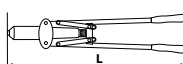

Ref.	Ø [mm]	L [mm]	Ø	EAN
18-106	3,2/4,0/4,8/6,0/6,4	480	0/10	5907558412246

Wyciskacz do tub

Caulking gun / Auspresser für Tuben / Выжиматель / Толкун для вытискивания монтажной пены / Kinyomápisztoly / Comprimator de tuburi / Aplikáční pistole na tuby / Vytlačáča túb / Pištola za tube / Hermetiko pistoletas / izspiedējs / Torutõmmits / Изтискивач за тубы / Istiskivača za tube / Istiskivača za tube / Pistola para tubos / Pistola per cartucce / Espresmedor para tubos / Pistolet pour tubes / Afdichtingspistool

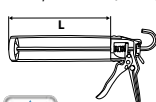

Ref.	L [mm]	Ø	EAN
61-001	240	0/24	5907558405842

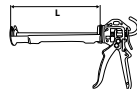

Ref.	L [mm]	Ø	EAN
61-004	240	0/12	5907558420821

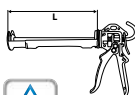

Ref.	L [mm]	Ø	EAN
61-002	240	0/12	590755840859

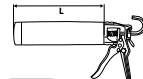

Ref.	L [mm]	Ø [mm]	Ø	EAN
61-005	310	254	0/12	5907558420838
61-006	600	389	0/12	5907558420845

Nůz z ostrzem łamany

Snap-off blade knife / Messer m. gebrochener Klinge / Нож с отламывающимся лезвием / Нож з ламаным лезом / Törhető pengés kés / Cutij lamá demontabilá / Nůz se zalomeným ostrím / Nožik lámaci / Nož / Petis su nutažiatia getežte / Тарешу наzis / Kokkukaiva teraga nuga / Макетен нож / Skalpel / Skalpel / Kanió «snap Offs» / Cúter / Taglierino con lama scorevole / Faca com lâmina curvada / Couteau à lame cassable / Met met gebroken lemmet

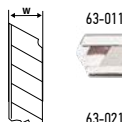

Ref.	W [m]	Ø	EAN
63-011	18	12/72	5907558410440
63-021	18	12/48	5907558410457

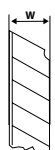

Ref.	W [m]	Ø	EAN
63-012	25	12/72	5907558443530

Ostrza łamane

Snip off blades / Klengen, abbrechbar / Лезвия сменные отламывающиеся / Леза змінні, що обламуються / Törhető penge titán élel / Lame cutter / Odłamowaci żepele / Odłamowaci żepele / Lomljiva rezila / Laužomi peiliikivi / Mainämie nolaužämie asmeji / Vaibanoo terad / Отчупващи се острувета / Lomljene ostrice / Ανασπώμενες λεπίδες / Hojas segmentadas / Ricambio lame scorrevoli / Lāminas curvadas / Lames coupées / Gebogen bladen

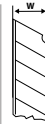
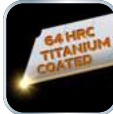
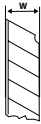

Ref.	W [m]	⊖	EAN
64-020	18	10/300	5907558400236



Ref.	W [m]	⊖	EAN
64-010	18	10/300	5907558400229

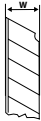

Ref.	W [m]	⊖	EAN
64-012	9	10/120	5907558443547
64-013	18	10/120	5907558443554
64-014	25	10/120	5907558443561

Ostrza trapezowe

Knife blades / Trapezklengen / Лезвия трапециевидные / Леза ножови / PVC penge / Cutit lamă / Lichoběžníkové ostří / Ůstrie lichoběžníkové / Nadomestna rezila / Keiřiamos geležties / Naža asmeji / Noaterad / Отщупе резероно / Nožici za skalpel / Nožici za skalpel / Αναπλακτικής λεπίδες / Hojas trapezoidales / Lame trapezoidali / Lāminasde trapēzio / Tranchans trapēzoidaux / Trapezium mesbladen



Ref.	⊖	EAN
64-015	10/240	5907558443578

Nóż z ostrzem trapezowym

Knife with utility blade / Messer mit Trapezklinge / Нож с трапециевидным лезвием / Нож з трапециевидним вістрям / Trapezpęnges őszszekukható kés / Cutter cu tăis trapezoidal / Nůž s trapēzovým ostřím / Nůž s trapēzovou řepelou / Nož s trapēzin rezilom / Peilis su trapēcine geležtie / Nazis ar trapēcevida asmeni / Trapēsteraga nuga / Нож с трапециевидно оступе / Nož s trapēzostom ostricom / Nož sa trapēzostom ostricom / Μαχαίρι με trapēzeϊδὴ ακμὴ / Cutler can hoja trapēzoidal / Taglierino a lama fissa / Faca com Lāminas de trapēzio / Couteau à lame trapēzoidale / Trapezium mes



Ref.	L [mm]	⊖	EAN
63-701	18	12/72	5907558400083

Nóż uniwersalny

Knife / Universalmesser / Нож универсальный / Нож / Trapezpęnges őszszekukható kés / Cutit / Univerzālni nůž / Nůž univerzālny / Nož / Universalus peilis / Nazis / Nuga / Ножке / Džepni nožici / Noz / Μαχαίρι γενικής χρήσης / Cuchillo universal / Taglierino a lama fissa / Faca universal / Couteau universel / Universele mes



Ref.	⊖	EAN
63-710	6/48	5907558420791

Nóż składany

Folding knife / Messer zusammenklappbar / Нож складной / Нож складний / őszszekukható kés / Briceag pliabil / Skládaci nůž / Skladaci nůž / Zložijiv nož / Sulankstomas peilis / Saliekamais nazis / Kokkukāiv nuga / Нож зсваем / Sklopiv nož / Nož na sklaranje / Μαχαίρι πλισσόμενο / Cuchillo plegable / Coltello a serramanico / Faca dobrável / Couteau pliable / Vouwmes



Ref.	⊖	EAN
63-026	6/48	5907558420975



Ref.	⊖	EAN
63-025	6/48	5907558420968

NEO
TOOLS

NARZĘDZIA MECHANICZNE

MECHANICAL TOOLS

МЕХАНИЧЕСКИЕ ИНСТРУМЕНТЫ

Narzędzie wielofunkcyjne

Multipurpose tool / Allzweckwerkzeuge / Инструмент универсальный / Инструмент многофункциональный / Multifunkciós szerszám / Uneahta multifunctionala / Multifunkční nástroj / Viacfunkčné náradie / Večfunkcijsko orodje / Daugiafunkciniai įrankiai / Daudzfunkcionālie instrumenti / Multifunktsoonaalne tööriist / Мультифункционален инструмент / Višenamjenski uređaj / Višefunkcionalne alatke / Πολυεργαλείο / Herramienta multiuso / Utensile multiuso / Ferramenta multifunções / Outil multifonction / Multifunctioneel gereedschap



- 1 szczypce / pliers / щипцы
- 2 otwieracz do butelek / bottle opener / открывалка для бутылок
- 3 otwieracz do puszek / can opener / открывалка для консервных банок
- 4 wkrętak PH2 / PH2 screwdriver / отвертка PH2
- 5 wkrętak płaski mały / small slotted screwdriver / отвертка шлицевая маленькая
- 6 wkrętak płaski duży / large slotted screwdriver / отвертка шлицевая большая
- 7 ostrze płaskie / plain blade / плоское лезвие
- 8 ostrze z zębami / serrated blade / зубчатое лезвие
- 9 piła do drewna / wood saw / ножовка по дереву
- 10 pilnik / file / зубчатое лезвие
- 11 wyruchacz do haczyków / hook extractor / съёмник крючков
- 15 blokada przed samoczynnym zamknięciem / lock against accidental closing / блокировка от самопроизвольного складывания
- 15 poręczny futerał / convenient case / удобный чехол

Ref.	L [mm]	⚖	EAN
01-028	150	6/36	5907558420951

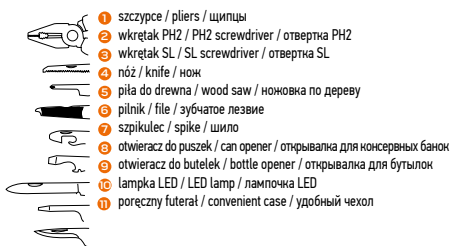

- 1 szczypce / pliers / щипцы
- 2 wkrętak PH2 / PH2 screwdriver / отвертка PH2
- 3 wkrętak SL / SL screwdriver / отвертка SL
- 4 nóż / knife / нож
- 5 piła do drewna / wood saw / ножовка по дереву
- 6 pilnik / file / зубчатое лезвие
- 7 szpikuliec / spike / шило
- 8 otwieracz do puszek / can opener / открывалка для консервных банок
- 9 otwieracz do butelek / bottle opener / открывалка для бутылок
- 10 lampka LED / LED lamp / лампочка LED
- 11 poręczny futerał / convenient case / удобный чехол



Ref.	L [mm]	⚖	EAN
01-027	105	6/48	5907558420944



Zestaw blokad rozrządu

Timing tool set / Nockenwellen-Arretierwerkzeugsatz / Набор фиксаторов распределвала для установки фаз ГРМ / Набор стопорів для розподільних валів / Vezérműtengely blokkoló készlet / Set de bloccarea distribuției / Sada blokovací pro opravy rozvodů / Súprava blokáď rozvodov / Set blokad gredi / Paskirstymo velenėlių fiksavimo kompleksas / Sadales mehānismu fiksatoru komplekts / Jauteus blokeerimise komplekt / Комплект блокировки на газораспределителе / Set alata za blokiranje radilice / Pribor za blokadu razvodjenja / Σετ συγκράτησης κνυδαφοφόρων αξόνων / Kit de bloqueo de la correa de distribución / Attrezzi di blocco dell'olbero a camme / Conjunto de bloqu coastas de engranagem de distribuição / Ensemble de verrouillage de distribution / Set van distributievergrendeling







Ref.	🔗	EAN
11-300	10/40	5907558436051



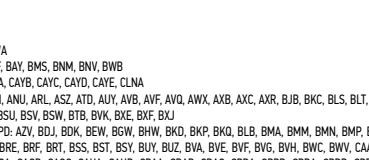

Audi: A1 (10-15), A2 (00-06), A3 (01-13), A4/Allroad (01-16), A5 (08-15), A6 (11-14), TT (08-14), Q3 (11-15), Q5 (08-15), A6 (10-14)
 Dodge: Caliber (06-11)
 Ford: Galaxy (02-06)
 Mitsubishi: Grandis (05-10), Lancer (05-10), Outlander (07-10)
 Seat: Alhambra (00-15), Altea/Altea XL (04-15), Cordoba (02-09), Ibiza (02-15), Leon (00-13), Toledo (04-11)
 Skoda: Fabia (00-14), Fabia II (07-15), Octavia (00-10), Octavia II (04-15), Praktik (10-15), Rapid (11-15), Roomster (07-15), Superb (02-08), Superb II (08-15), Yeti (09-14)
 VW: Amarok (10-14), Beetle (02-15), Bora (02-08), Caddy/Maxi (03-15), EOS (05-11), Fox (05-11), Golf (02-15), Golf Plus (05-14), Jetta (05-15), Lupo (02-05), Passat/CC (02-15), Polo (99-14), Scirocco (08-14), Sharan (02-15), Tiguan (07-15), Touran (03-15), Transporter (03-18)





Ref.	🔗	EAN
11-301	10/40	5907558436068





Audi: A1, A3, A4 (B8), A5, A6 (C6, C7), TT, Q3, Q5
 VW: Golf V-VI, Passat B6, B7, Polo, Jetta V-VI, Scirocco III, Beetle II, Caddy, Touran, Sharan II, T5
 SKODA: Fabia, Roomster, Practic, Octavia II, Superb II, Yeti
 SEAT: Ibiza, Leon, Exeo, Altea, Alhambra II

Ref.	🔗	EAN
11-302	1/5	5907558436075





Audi: A4 2.7 TDI (05-09); A4 Quattro 2.0 TDI (05-06); Q7 3.0 TDI (06-09)
 Volkswagen: Touareg 3.0 V6 TDI (08-); Phaeton 3.0 V6 TDI (06-); Diesel 2.7 TDI, 2.0 TDI 3.0 TDI

Ref.	🔗	EAN
11-303	1/5	5907558436082





Benzyzna / Gasoline / Бензин: 1,2 6V/12V / 1,4 16V / 1,6 16V / 1,4FSI / 1,6FSI
 Diesel: 1,2TDi / 1,4TDi / 1,9TDi / 2,0TDi / 2,5 V6 TDi / 3,3 V8 TDi / 2,0TDi (PD oraz CR) / 1,6 TDi CR
 Kody silników / Engine codes / Коды двигателей
 ANY, ASZ, ATD, AMF, ATL, BHC, AXR, AVB, AVX, AWX, AMF, BMS, BNM, BNV, ANU, ARL, AUY, BTB, BVK, BVB, BXC, AZV, BKD, AXB, AXC, BDJ, BST, AJM, AYZ, BWB, BAY, AXG, AXL, AYC, AVQ, BMP, BRM, BRU, BSU, BXE, BXF, BMM, BDK, AZU, BMM, ATJ, BGW, BHW, ACH, AVY, AJ
 OEM: T10123 | T10120 | 3458 | 3418 | 2065A | 3366 | T10098 | T10121 | 3242 | T10050 | T10100 | T10060A | T10020 | T10008 | T40011 | 3359 | 2064 | 3369 | T10016 | T10264 | T10265

Ref.	🔗	EAN
11-304	1/4	5907558436099





Audi: A3, S3, A5, A6, TT (03-11), SEAT: Ibiza, Leon, Altea, Exeo (04-11)
 SKODA: Fabia II, Octavia II, Roomster, Superb II (04-11).
 VW: Golf, Golf Plus, Jetta, Eos, Scirocco, Tiguan, Touran, Passat (03-11)

Ref.	🔗	EAN
11-306	1/10	5907558436112

Zestaw blokad rozrządu

Timing tool set / Nockenwellen-Arretierwerkzeugsatz / Набор фиксаторов распределения для установки фаз ГРМ / Набор стопорів для розподільювальних валів / Vezérműtengely blokkoló készlet / Set de blocarea distribuției / Sada blokovaci pro opravu rozvodů / Súprava blokad rozvodov / Set blokad gredi / Paskirstymo velenėlių fiksavimo kompleksas / Sadales mehānismu fiksatoru komplekts / Jaotuse blokeerimise komplekt / Комплект блокировки на газораспределителе / Set alata za blokiranje radilice / Pribor za blokadu razvodjenja / Σετ συγκράτησης κνυδακοφόρων αξόνων / Kit de bloqueo de la correa de distribución / Attrezzi di blocco dell'albero a camme / Conjunto de bloques de engranagem de distribución / Ensemble de verrouillage de distribution / Set van distributievergrendeling



Audi: A1 (10-15), A3 (03-13)
Seat: Alhambra (10-15), Altea/Altea XL (08-15), Ibiza/Cordoba (08-12), Leon (07-13), Toledo (07-15)
Skoda: Fabia II (07-15), Octavia II (04-15), Praktik (10-15), Rapid (12-15), Roomster (04-15), Superb II (09-14), Yeti (09-14)
VW: Beetle (11-15), Caddy/Caddy Maxi (10-15), EOS (04-12), Golf (03-12), Golf Plus (03-14), Golf V Estate (07-13), Golf VI Cabriolet (10-15), Jetta (04-14), Passat (05-11), Polo (02-14), Scirocco (08-12), Tiguan (07-12), Touran (03-15)



1.2 TFSI:CBZA, CBZB, CBZC
1.4 FSI:AXU, BKG, BLN
1.4 TFSI:BLG, BMY, BWK, CAVA, CAVB, CAVC, CAVD, CAVE, CAVF, CAXA, CAXC, CDGA, CSMA
1.6 FSI:BAG, BLF, BLP, BTS
DEM VAG: T10170, T10171A, T40011, T10340, T10414

Ref.	🔧	EAN
11-305	1/10	5907558436105



AUDI: A1 - A1 Sportback - A3 - A3 Sportback - A3 CABRIO - S1 - S1 Sportback
SEAT: Alhambra - Altea - Altea XL - Ibiza - Leon - Cordoba - Toledo
SKODA: Octavia II - Praktik - Roomster - Superb II - Yeti - Yeti Outdoor - RAPID - Rapid Spaceback - Superb II
VW: Beetle - Caddy - Caddy Maxi - Eos - Golf Plus - Golf V - Golf V Estate - Golf VI - Golf VI Cabrio - Golf VI Estate - Jetta - Passat - Polo - Scirocco - Sharan - Tiguan - Touran - CC



1.2 FSI/TFSI:CBZA - CBZB - CBZC
1.4 TSI /1.4 / 1.6 FSI:AXU - BAG - BKG - BLF - BLG - BLN - BLP - BMY - BTS - BWK CAXA (03-)
DEM VAG: T10340, T10414, T10171A, T40011, T10170, VAS6079, T10341

Ref.	🔧	EAN
11-307	1/5	5907558436129



Audi: A3 (2013-)
Seat: Mii (2012-), Leon (2012-), Toledo (2012-)
Skoda: Citigo (2012-), Octavia (2013-), Rapid (2012-)
VW: Up (2012-) and Polo mk5 (2014-), Golf VII (2012-), Jetta (2012-)



1.0 EcoFuel, Ecomotive, Bluetmotion, Green Tech
CHYA, CHYB, CPGA
1.2 TFSI: CJZA, CJZB
1.4 TFSI: CMB, CAXA, CHPA
1.4 TGI: CPWA
1.4 TSI Multi Fuel CPVA
1.4 Hybrid CRJA
DEM VAG: T10340, T10477, T10476, T10499, T10494, T10487

Ref.	🔧	EAN
11-338	0/2	5907558451214



116i E81/E82/E7/88 (07-12), 118i E81/E82/E7/88 (06-14), 120i E81/E82/E7/88 (06-14)
BMW 3 Series: 316i E90/E91/E92/E93 (07-11), 318i E90/E91/E92/E93 (07-13), 320i E90/E91/E92/E93 (07-14)
BMW 5 Series: 520i E60/E61 (07-10)



N43: B16A/AA, B16AA, B16AA/00, B20A, B20A/AA, B20AA, B20AY, B20K, B20U0
DEM BMW: 11.8.690 (11.8.691/11.8.692/11.8.693), 11.9.340 (11.9.341/11.9.342), 11.8.710 (11.8.711/11.8.712), 11.3.340, 11.5.120, 11.8.700

Ref.	🔧	EAN
11-310	1/5	5907558436136



BMW 1 Series: 118i E81/E82/E7/88 (04-14), 120i E81/E82/E7/88 (04-14)
BMW 3 Series: 316i/ti Compact E46 (01-07), 318i/ti Compact E46 (01-07), 318i E90/E91/E92/E93 (05-12), 320i E90/E91/E92/E93 (05-14)
BMW 5 Series: 520i E60/E61 (07-10)
BMW X Series: X1 E84 sDrive 18i (10-12), X1 E84 xDrive 18i (10-12), X3 E83 2.0 (05-10)
BMW Z Series: Z4 2.0 E85/E86 (04-09)

Ref.	🔧	EAN
11-313	1/5	5907558436167



BMW 1 Series: 118i E81/E82/E7/88 (04-14), 120i E81/E82/E7/88 (04-14)
BMW 3 Series: 316i/ti Compact E46 (01-07), 318i/ti Compact E46 (01-07), 318i E90/E91/E92/E93 (05-12), 320i E90/E91/E92/E93 (05-14)
BMW 5 Series: 520i E60/E61 (07-10)
BMW X Series: X1 E84 sDrive 18i (10-12), X1 E84 xDrive 18i (10-12), X3 E83 2.0 (05-10)
BMW Z Series: Z4 2.0 E85/E86 (04-09)



2.0: N42 B18A, N42 B20A, N46 B18, N46 B20, N46 B20B, N46T B20B, N46T B20BD, N46T B20BZ, N46T B20O2, N46T B20O2
DEM BMW: 11.9.301, 11.9.303, 11.9.300, 11.9.310, 11.9.320, 11.9.390

Ref.	🔧	EAN
11-312	1/5	5907558436150



2.0:
N42 B18A, N42 B20A, N46 B18, N46 B20, N46 B20B, N46T B20B, N46T B20BD, N46T B20BZ, N46T B20O2, N46T B20O2
DEM BMW: 11.9.310 | 11.9.320 | 11.9.302 | 11.9.301 | 11.9.290 | 11.9.302 | 11.9.340 | 11.9.390 | 11.9.350 | 11.9.270 | 11.2.300 | 11.9.190 | 11.9.330

Zestaw blokad rozrządu

Timing tool set / Nockenwellen-Arretierwerkzeugsatz / Набор фиксаторов распределения для установки фаз ГРМ / Набор стопорів для розподільвальних валів / Vezérműtengely blokkoló készlet / Set de blocarea distribuției / Sada blokovací pro opravy rozvodu / Súprava blokáď rozvodov / Set blokad gredi / Paskirstimo velenių fiksuojimo komplektas / Sadales mehānisms fiksatoru komplekts / Jaotuse blokeerimise komplekt / Комплект блокировки на газораспределителе / Set alata za blokiranje radilice / Pribor za blokadu razvodjenja / Set συγκράτησης κνυδαφοφόρων αξόνων / Kit de bloqueo de la carrea de distribución / Attrezzi di blocco dell'albero a camme / Conjunto de bloqu coastas de engragament de distribución / Ensemble de verrouillage de distribution / Set van distributievergrendeling



BMW 1 Series: 125i E88 (07-13), 128i E82/88 (07-08), 130i E81/87 (05-12), 135i/S E82 (07-11), M Coupe (11-12)
 BMW 3 Series: 323i E90/91/92/93 (04-11), 325i E90/91/92/93 (05-13), 328i E90/91/92/93 (04-08), 330i E90/91/92/93 (04-14), 335i E90/91/92/93 (05-11)
 BMW 5 Series: 523i/Li E60/61/F10/11 (04-11), 525i E60/61 (04-10), 528i E60/61/F10/11 (06-11), 530i E60/61/F10/11 (04-13), 535i E60/61 (04-08)
 BMW 6 Series: 630i E63/64 (04-11)
 BMW 7 Series: 730i E65/66 F01/02/04 (04-11), 740i F01/02/04 (08-12)
 BMW X Series: X1 E84 xDrive 20i (11-14), X1 E84 sDrive 20i (11-14), X1 E84 xDrive 28i (11-14), X1 E84 3.0 xDrive 25i (10-11), X1 E84 xDrive 28i (09-11), X3 F25 20i (11-14), X3 E83 2.5Si (06-10), X3 E83 3.0i/Si (04-10), X3 F25 3.0 xDrive 28i (11-13), X5 E70 3.0Si/sDrive 30i (06-10), X6 E71/72 3.0 xDrive 35i (08-10)
 BMW Z Series: Z4 E85/86 2.5i/Si (05-09), Z4 E85/86 3.0i/Si (05-09), Z4 E89 2.5 sDrive 23i (09-11), Z4 E89 3.0 sDrive 30i (09-11), Z4 E89 3.0 sDrive 35i (09-13)

Ref.	⊞	EAN
11-311	1/2	5907558436143



BMW:
 118d / 120d: E87;
 318d / 318td Compact / 320td Compact / 320d / 330d: E46;
 316i: 316i, 318i, 318i, 320i E90/E91;
 318i: 320i E90/E91/E92/E93: S20d / S25d / S30d: E39;
 318tds / 318tds Compact (1994-2000) / 325td / tds (1991-99): E36
 S25d / S30d / S35d: E60/E61;
 S25td / tds (1991-2003): E34/E39
 635d: E63;
 725tds (1991-2003) M47 / M47 TU / T2 / M57 TU T2: E38;
 730d: E38/E45/E66;
 X3: 2.0i / 3.0i d: E83;
 X5: 3.0i d: E53/70;
 Land Rover: Range Rover: 2.5 TD (1994-2002) Range Rover: 3.0 TD4 (2002-2006) Freelander: 2.0 TD4 (2002-2006)

Ref.	⊞	EAN
11-316	1/2	5907558436198



N52/N52K: B25A, B25A/01, B25AE, B25AF, B25BE, B2501, B2502, B25U1, B30/02, B30A, B30A/01, B30AE, B30AF, B3002, B30U1, N53/N54: B25A, B30A, B30A/AA, B30A/00, B30A/0T, B3000, B30TD, B30UD, OEM BMW: 1110300 | 1142800 | 1142811 | 1142822 | 1142833 | 1142910 | 118520



M41, M51, M47 - M47 TU/T2, M57 TU/T2: 2.0i, 3.0i - 1998 - 2008
 OEM BMW: 11 2 300 | 11 3 320 | 11 3 340 | 11 3 360 | 11 5 180 | 11 6 080 | 11 6 320 | 11 6 321 | 11 6 322 | 13 5 120 | 13 5 190 | 13 5 191 | 13 5 192
 OEM Land Rover: LRT-12-108 | LRT-12-112 | LRT-12-115 | LRT-12-114 | LRT-12-119
 OEM Opel: KM-6267 | KM-6269 | KM-6268 | KM-813 | KM-823

Ref.	⊞	EAN
11-316	1/2	5907558436198



BMW: N42 / N46 / N46T - Valvetronic
 Seria 1: E87 118i/120i (04-10)
 Seria 3: E46 316i/316i Compact, 318i Compact (01-05), 318i (01-07), E90 318i (05-08)
 Seria 5: E90 520i (04-08), X3 E83 2.0i (05-09)



N46, B18, B20B, B20, N42, B18A, B20A, N46T
 OEM BMW: 11 3 350 | 11 9 293 | 11 9 292 | 11 9 291 | 11 9 340 | 11 5 120 | 11 9 270 | 11 9 190

Ref.	⊞	EAN
11-314	1/5	5907558436174



Citroen: AX, ZX, XM, Xsara, Xantia, Dispatch, Evasion, Berlingo, Jumpy, C2, C3, C5
 Peugeot: 106, 205, 206, 305, 306, 307, 309, 405, 406, 406 Coupe, 605, 607, 806, 807, Express, Expert, Partner, Boxer.



Benzyna / Gasoline / Бензин: 1.0 / 1.1 / 1.4 / 1.6 / 1.8 / 2.0 / 2.0 HPI
 Diesel: 1.8 / 1.9 / D / TD 1.4 / 2.0 / 2.2 / HDI 2.1 / 2.2 / 2.5 / TD
 OEM: 4 4507-TJ | 0132X | 9767 89 | 0132X12 | 01320 | 5711-TA | 4507-TB | 0132R | 9767 27 | 7014-TM | 4507-TA | 01320Z | 0189-C | 01536 | 0153B | 0153N | 0188D | 7017-TR | 0118X | 7004-TG | 7014-TJ | 7017-TR | 0132AB | 4527-TS2 | 5711-TD | 0189-B | 5711-TC | 9041-T2 | 0188-H | 4527-S1 | 0132AJ2 | 0188M | 4533-TAC2 | 0132AJ1 | 4533TAC1 | 0189-A | 0189AZ | 0189-L | 0188Y | 0286D | 7099-TM | 7014-TJ | 0188P / P2 | 7015T | 0134AF | 0188F | 9044

Ref.	⊞	EAN
11-320	1/4	5907558436211



BMW 1.6 2.0 3.0 d
 118d E81, 118d E87 - (2006-2010)
 120d E81, 120d E82, 120d E87 - (2006-2010)
 123d E81, 123d E82, 123d E87 - (2007-2010)
 318d E90, 318d E91 - (2007-2010)
 320d E90, 320d E91, 320d E92 - (2005-2010)
 520d E40, 520d E61 - (2004-2008)
 X3 2.0d E83 - (2007-2010)



N47, N47S D20A, N57
 OEM BMW: 11 6 480 | 11 8 760 | 11 8 760 | 11 8 741 | 118742 | 11 5 320

Ref.	⊞	EAN
11-315	1/10	5907558436181



BMW 3 Series: 318tds E36 (94-99), 318tds Compact E36 (95-00), 325td / tds E36 (91-99)
 BMW 5 Series: 525td / tds E34 (91-96), 525td / tds E39 (97-03)
 BMW 7 Series: 725tds E38 (94-02)
 Land Rover: Range Rover (94-02)
 Vauxhall/Opel: Omega-B (94-01)



1.7D: M41/174T1 2.5D: M51/256T1, M51/256T1L 2.5D Turbo: M51, 256T, 25TD, X25TD
 OEM BMW: 11 2 150, 13 5 062, 11 3 340, 11 3 360, 11 3 320, 13 5 120, 11 2 300
 OEM Land Rover: LRT-12-118, LRT-12-112, LRT-12-114, LRT-12-119, LRT-12-118
 OEM Vauxhall/Opel: KM-819, KM-826, KM-823, KM-822, KM-811, KM-825, KM-813

Ref.	⊞	EAN
11-317	1/2	5907558436204

Zestaw blokad rozrządu

Timing tool set / Nockenwellen-Arretierwerkzeugsatz / Набор фиксаторов распределения для установки фаз ГРМ / Набор стопорів для розподільювальних валів / Vezérműtengely blokkoló készlet / Set de bloccarea distribuției / Sada blokovači pro opravu rozvodů / Súprava blokáď rozvodov / Set blokad gredi / Paskirstymo velenių fiksavimo kompleksas / Sadales mehānisms fiksatoru komplekts / Jaotuse blokeerimise komplekt / Комплект блокировки на газораспределителе / Set alata za blokiranje radilice / Pribor za blokadu razvodjenja / Σετ συγκράτησης κνιβοβαθρών αζώνων / Kit de bloqueo de la correa de distribución / Attrezzi di blocco dell'albero a camme / Conjunto de bloqu coastos de engranagem de distribuição / Ensemble de verrouillage de distribution / Set van distributievergrendeling



RENAULT: Clio, Clio Sport, Twingo, Kangoo, Megane, Scenic, Laguna, Espace, Safrane, Spider, R19, Master, Trafic
 OPEL: Arena, Movano
 VOLVO: S40, V40
 Gasoline engine: 1.2 / 1.4 / 1.6 / 1.7 / 1.8 / 2.0 / 2.2 / 1.4 16V / 1.6 16V / 1.8 16V / 2.0 16V / 2.5 20V
 Diesel Engine: 1.9 / 2.5 / 2.8



B16, B18, B20, N70, K4J, K4M, F4P, F4R, D7F, E5F, E7F, E7J, K7M, FIN, F3N, F3P, F2R, F3R, F7P, F7R, J5R, J7R, J5T, F8M, F8Q, G8T, J8S, F9Q, S8U, S9P, S9W
 OEM: MOT1348 | MOT1312 | MOT1135 - 01 | MOT1384 | MOT1337 | MOT1146 | MOT1019 - 1 | MOT910 | MOT861 | MOT863 | MOT1054 | MOT1318 | MOT1489 | MOT1340 | MOT1386 | MOT1490 - 1

Ref.	📦	EAN
11-322	1/4	5907558436235



FIAT Ducato, IVECO Daily 2002-2009
 CITROEN Relay, Jumper III 2004-2009
 PEUGEOT Boxer III 2006-2009



2.3 JTD - F1AE0481C, F1AE0481D, F1AE0481N,
 3.0 JTD - F1CE0481D (2004-)
 3.0HDi - F30DT
 OEM: 99360614(-), 01912/B, 99360615/2, 000, 018, 200/
 (-), 1912/A, 99360608/1, 860, 617, 000

Ref.	📦	EAN
11-325	8/32	5907558436266



FIAT: Bravo/Brava, Barchetta, Coupe, Doblo Cargo, Idea, Marea/Weekend, Multipla, Siena, Palio/Weekend, Punto, Stilo
 Silniki benzynowe / Gasoline engine / Бензиновый двигатель:
 1.2; 1.4; 1.6; 1.8 16V
 Bravo/Brava, Cargo, Doblo, Ducato, Marea/Weekend, Multipla, Palio/Weekend, Punto, Scudo, Stilo, Ulysse, Dukato, Cromia itd



Silniki diesla / Diesel engine / Дизельный двигатель:
 1.9D, 1.9TD, 1.9JTD, 2.4TD, 2.4JTD
 OEM: 1840847000 | 1840875000 | 1870697000 | 1840895000 | 1895879000 | 1840898000 | 1840920000 | 1840771000 | 1840161000 | 1840874000 | 1840876000 | 1840845000 | 1840876000 | 1840945000 | 1840901000 | 1840905010 | 1840987000 | 1840985000

Ref.	📦	EAN
11-326	1/4	5907558436273



Citroen: C4 Picasso/Grand Picasso (06-10), C5 II (04-08), C8 (05-10), Dispatch/Jumpy (07-11), Xsara 2.0 16V, C5 1.8/2.0/HPi, Xsara Picasso 1.8/2.0 16V (02-05)
 Peugeot: 406 1.8 16V (00-04), 407 (06-10), 807 2.0 16V (02-05)



1.8 16v: EW7A(FY)
 2.0 16v: EW10A(RFJ), EW10ABE(RFH), EW10JAS(RFK)
 OEM: 0189S1, 0189S2, 0132AB / 0194A/0178D, 0194B, 0188M, 0189P, 0188AH, 0189R, 70177R / 0153U, 0188J2, 0188J/J2, 0178E / 5711TE

Ref.	📦	EAN
11-321	1/4	5907558436228



FIAT: Panda, Idea, Doblo
 OPEL: Agila, Corsa, Astra H, Tigra B, Meriva
 ALFA ROMEO: 147, 156
 OPEL: Astra, Vectra, Signum, Zafira



1.3 JTD MULTIJET (04-07)
 1.3 CDTi (04-07)
 1.9/2.4 JTD, 14V, 20V
 1.9 JTD 16V/ 2.4 JTD 20V
 1.9 CDTi (04-06)
 1.7D / 1.9 D FIAT / JTD / TD 2.4

Ref.	📦	EAN
11-323	1/4	5907558436242



ALFA ROMEO: Mito (10-15)
 FIAT: 500 (07-15), 500C (07-15), Doblo/ Cargo (05-10), Fiorino (09-15), Grande Punto (07-12), Idea (05-12), Linea (07-11), Panda/ Panda Classic (09-13), Panda EV02 (05-12), Punto Evo (09-12), Punto (12-15), Qubo (09-15), Seicento (600 (00-11)
 FORD: Ka (09-15)
 LANCIA: Musa (05-13), Ypsilon (04-15)



FIAT: 1.1 8v: 187A1.000, 1.2/1.2 Dualogic: 169A4.000, 188A4.000 (EV02 only), 199A4.000, 1.4/1.4 Bi-Fuel LPG/1.4 Natural Power CNG: 199A7.000, 350A1.000
 Ford: 1.2 Duratec: 169A4.000(FPA)
 Lancia: 1.2 8v: 188A4.000, 1.4/1.4 Bi-Fuel LPG: 350A1.000
 OEM Ford: 303-1477 | 303-1478 | 303-1480 | 303-1479
 OEM Fiat: 2000004200 | 2190754200 | 2000004300 | 2000004400 | 2190754400 | 2191946400 | 2000004500 | 2190754500 | 2191946400 | 1840987000

Ref.	📦	EAN
11-324	1/5	5907558436259

Zestaw blokad rozrządu

Timing tool set / Nockenwellen-Arretierwerkzeugsatz / Набор фиксаторов распределителя для установки фаз ГРМ / Набор стопорів для розподільвальних валів / Vezérműtengely blokkoló készlet / Set de blocarea distribuției / Sada blokovací pro opravy rozvodů / Súprava blokad rozvodov / Set blokad gredi / Paskirstymo velenėlių fiksavimo kompleksas / Sadales mehānisms fiksatoru komplekts / Jaotuse blokeerimise komplekt / Комплект блокировки на газораспределителе / Set alata za blokiranje radilice / Pribor za blokadu razvodjenja / Σε συγκράτηση κνυδαφοφόρων αξόνων / Kit de bloqueo de la correa de distribución / Attrezzi di blocco dell'albero a camme / Conjunto de bloqu coastes de engr enagament de distribución / Ensemble de verrouillage de distribution / Set van distributievergrendeling



OPEL:
Astra, Vectra B/C, Zafira, Signum,
Frontera
Silnik benzynowy/Gasoline engine:
2.2 16V



Z22SE, Z22YH

Ref.	⊞	EAN
11-331	1/5	5907558436297



OPEL:
AGILA, ASTRA, CORSA, FRONTERA, OMEGA,
SINTRA, VECTRA, TIGRA, ZAFIRA, (SAAB,
RENAULT)



Silniki diesla /Diesel engine / Двухельный
двигатель:
1.3CDTi 16V, 1.9CDTi, 2.0 Di, 2.2DTi
OEM: KM-952/09912-38310, KM-
953/09919-58310, KM-954/09919-08310,
KM-955/09919-58320, KM-6130

Ref.	⊞	EAN
11-330	1/2	5907558436280



FORD:
Focus, C-Max, Mondeo
(2003-2010)



Silniki benzynowe / Gasoline engine / Бензиновый двигатель: 1.6 16V
Kody silników / Engine codes / Коды двигателя: HXDA (2003-2007), HXJA, PNBA, RHBA,
Silniki diesla /Diesel engine / Дизельный двигатель: 2.0 TDCi
Kody silników / Engine codes / Коды двигателя: 6A0A, 6A0B, 6A0C (2003-2007)
OEM Ford: 303-1097 | 303-1054 | 303-1059 | 303-1270 | 303-748 | 303-735 | 303-1277 | 21-259 | 21-263
OEM Peugeot: 0188X | 0187B | 0189B | 0188M | 0194B | 0132AJ
OEM Citroen 0188X | 0187B | 0189B | 0188M | 0194B | 0132AJ
OEM Renault: MOT1430
OEM Volvo: 9997121 | 9997152 | 9997122

Ref.	⊞	EAN
11-335	1/10	5907558436334



MAZDA: 1.4 1.8 2.0 2.4 2.5 TDCi,
TD, Di, SCI
FORD: Fiesta, Courier, Escort, Orion,
Sierra, Mondeo, Focus, Transit,
Tourneo, Fusion.



Diesel: 1.4 TDCi, 1.8 D/TD, 1.8 Di, 1.8 TDCi, 2.0TD/TDCi, 2.4 D, 2.5 Di/Turbo/Tci
Benzyna /Gasoline / Бензин: 1.8 Duratec – SCI
Kody silników / Engine codes / Коды двигателя:
C9DC, F9DA/B, C9DA/B, B9DA/B, B9PA, HCPA, FFDA, HCPB, P7PA, P9PA, R2PA, R3PA, RWPA, RFX, RFN, RFD,
RTJ, RTK, 4EB, 4EC, 4ED, 4FA, 4FB, 4FC, 4FD, 4GA, 4GB, 4GC, 4GD, 4GE, 4HB, 4HC
OEM Mazda: 49 JE01 061
OEM Ford: 21-162 | 21-162B | 303-367 | 303-376 | 23-059 | 310-085 | 21-168 | 303-393 | 23-020 | 23-047 |
23-020 | 21-163 | 303-620 | 23-019 | 21-210 | 303-507 | 21-251 | 303-698 | 21-262 | 303-734 | 23-029 | 303-
1061 | 23-058 | 310-084 | 21-105 | 21-262 | 303-734 | 21-168 | 303-393 | 21-263 | 303-735
OEM VAG: 3359 | T10008 | T10050 | 2065A

Ref.	⊞	EAN
11-333	1/4	5907558436310



Chrysler Voyager (2001-2008)
Chrysler Grand Voyager (2001-2008)
Jeep Cherokee (2001-2008)
LDV Maxus (2005-2008)



R2516C, R2516L, R2816K, VM2516L
OEM: VM1052 | VM9660 | VM8873 |
VM1080 | VM1068 | VM1089 | VM1053
Chrysler

Ref.	⊞	EAN
11-332	1/10	5907558436303



FORD:
Galaxy, Mondeo, S-Max, Focus 2010-



Silniki benzynowe / Gasoline engine /
Бензиновый двигатель:
2.0 SCTi EcoBoost/Ti-VCT
Kody silników / Engine codes / Коды
двигателя:
TNWA / TNWB / TNBA / TPWA / MCGA / XODA
OEM: 303-748 | 303-1504 | 303-1545 | 303-
1521

Ref.	⊞	EAN
11-336	1/5	5907558436341

Zestaw blokad rozrządu

Timing tool set / Nockenwellen-Arretierwerkzeugsatz / Набор фиксаторов распредела для установки фаз ГРМ / Набор стопорів для розподільвальних валів / Vezérműtengely blokkoló készlet / Set de blocarea distribuției / Sada blokovacvi pro opravu rozvodu / Súprava blokad rozvodu / Set blokad gredi / Paskirstymo velenių fiksavimo komplektas / Sadales mehānismu fiksatoru komplekts / Jaotuse blokeerimise komplekt / Комплект блокировки на газораспределителе / Set alata za blokiranje radilice / Pribor za blokadu razvođenja / Set συγκράτησης κωδικοφορών αξόνων / Kit de bloqueo de la correa de distribución / Attrezzi di blocco dell'albero a camme / Conjunto de bloqu coastas de engr enagem de distribu ión / Ensemble de verrouillage de distribution / Set van distributievergrendeling



VOLVO:
Stilinski benzynowe/gasoline engine: 4,5, 6 cylinder
S80 (07-), V70 (08-), S80 (06-), XC90, V70 (00-08),
V70 XC (01-) / XC70 (-07), S40, C30, C70 (06-), S40
(04-), V50, S40 (-04), V40, 850, C70 Coupe (-05),
S70, V70 (00-), V70 XC (00-), 940, S90, V90

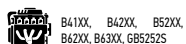

Ref.	⊞	EAN
11-337	1/2	5907558436358

Komplet ściągaczy do szpilek

Roller stud extractor set / Abszieher-set / Набор ключей для снятия штифтов / Комплект выкруток до шпильок / Törtszavar-kihajtó készlet / Set complot de extractoare pentru / Sada stahovadel na závrtné šrouby / Súprava valčekových stahovákov skrutiek / Komplet smalnacev zatičev / Nuemtųjų rinkinys smeigėms / Novičijev kompleks tapkskrutėm / Varadátimmitaste komplet / Комплект экстракторов для шпильки / Set skidača za nasadne ključevce / Komplet stega za igle / Set klebiadi aparitisi neipov / Juego de extractores para agujas / Set estrattori / Kit de sacadores de pregos / Jeu d'extracteurs de goujon / Set van trekkers voor naalden



1/2" x4

Ref.	Ra[mm]	⊞	EAN
09-608	6, 8, 10, 12	0/24	5907558416534

Nasadki do sondy lambda i wtryskiwaczy

Oxygen sensor and fuel injectors wrench set / Ausrätze für lambda-sonden und einspritzdüsen / Набор насадок для лямбда-зонда и форсунок / Nasadki do lямбда-sondів і форсунок / Injector és lямбdaszonda szerelő készlet / Ajutaj pentru sonda lямбda și injectoare / Klіče na lямбda sondy a vsřikovací trysky / Nastavce na lямбda sondy a vstřekovače / Nasadni ključji za sonda lямбda in injektorji / Galvucių rinkinys lямбda zondai ir purkštukams / Lambda zondes un sprauslu uzgali / Lямбda sondi otsakud ja pihustid / Напратици за лямбда сонда и за инжектори / Nasadni ključevci za lямбda sondy ubrizgivača / Nastavci za sonda lямбda i brizgalice / Set karbičnika kaj akropolija i aviofitra lямбda kaj euzitipes / Casquillos para sonda lямбda y para injector / Bussole per sonda lямбda e iniettori / Bocais para a sonda lямбda e injetores / Douilles pour sondes lямбda e injecteurs / Doppen voor lямбdasonde en inspuiters



- 78 mm x 17, 19, 27, 28, 30 mm
- 80 mm x 27 mm
- 85 mm x 21 mm
- 90 mm x 22 mm
- 110 mm x 27 mm
Nasadka sześciokątna 1/2" do sondy lambda / 6 point socket 1/2" for oxygen sensors / Головка 6-гранная 1/2" для лямбда-зонда:
- 80 mm x 20 mm
Nasadki odgięte do sondy lambda / Offset sockets for oxygen sensors / Головки для лямбда-зонда:
- 31 mm x 22 mm x 3/8"
- 50 mm x 22 mm x 1/2"
Nasadki dwunastokątna 1/2" do wtryskiwaczy / 12 point sockets 1/2" for diesel injectors / Головки 12-гранные для форсунок:
- 110 mm x 22 mm
- 150 mm x 22 mm

Ref.	⊞	EAN
11-880	0/5	5907558436877



Ford: Mondeo (00-07), Transit (00-14)
Citroen: Relay/Jumper III (06-13)
Fiat: Ducato (06-11) / Ducato (06-11)
Jaguar: X-Type (03-10)
Land Rover: Defender T4d (06-11)
LDV: Convoy (02-04)
Peugeot: Boxer III (06-12)

Ref.	⊞	EAN
11-334	1/5	5907558436327

2.0D TiD/tdc: ABFA, D3FA, F3FA, D5BA, D6BA, F1FA, F6BA, F6BB, H1BA, H1BB, H1BC, H1BE, N7BA, N7BB
2.2D TDCi/ECOnetic: BG, CYFA, CYFB, CYFC, DRFA, DRFB, DRFC, PRFA, PRFB, PRFC, PGFA, PGFB, Q1BA, Q1BB, Q1BC, Q1BD, QVFA, QVFB, SRFA, SRFB, SRFC, SRFD, SRFE, UHFA
2.2D HDi/JTD:
P220TE (4HM), P220TE (4HU), P220TE (4HV)
2.4D TiD/CdC: D0FA, D2FA, D2FB, D4FA, F4FA, F4FB, H9FB, H9FD, JXFA, JXFC, PHFA, PHFC
2.4D TdI:
Z5D 424
2.4D Td4:
244DT
OEM: 303-679A/Z1-238, 303-1151, 303-698/Z1-251, 303-675/Z1-234

Ściągacz uniwersalny

Universal pulley puller / Universalabzieher / Универсальный съёмник / Знімач універсальний / Universalis agylehűző / Extractor universal / Univerzální stahovák / Univerzálny stahovák / Univerzalnizvlekač / Universalis nutraukiklis / Universalis novičij / Universalis iāmmitis / Universalen sloba za demontaž / Univerzalniz skidač / Univerzalna alatka za skidanje / Εξολκιστή γενικής χρήσης / Extractor universal / Estrattore universale / Extrator universal / Extracteur de poulie universel / Universele poelietrekker



Ref.	⊞	EAN
11-299	1/10	5907558436044



Nasadki dwunastokątna 1/2" do sondy lambda / 12 point sockets 1/2" for oxygen sensors / Головки 12-гранные для лямбда-зонда:
- 78 mm x 22, 28 mm
- 80 mm x 27 mm
Nasadka sześciokątna 1/2" do sondy lambda / 6 point socket 1/2" for oxygen sensors / Головка 6-гранная 1/2" для лямбда-зонда:
- 90 mm x 29 mm
Nasadki sześciokątna 3/8" do sondy lambda / 6 point sockets 3/8" for oxygen sensors / Головки 6-гранная 3/8" для лямбда-зонда:
- 74 mm x 27 mm
- 80 mm x 22 mm
- 90 mm x 22 mm
Odgięte nasadki do sondy lambda / Offset sockets for oxygen sensors / Головки для лямбда-зонда:
- 31 mm x 22 mm x 3/8"
- 50 mm x 22 mm x 1/2"
Nasadka dwunastokątna 1/2" do wtryskiwaczy / 12 point socket 1/2" for diesel injectors / Головка 12-гранная для форсунок:
- 108 mm x 22 mm

Ref.	⊞	EAN
11-882	0/5	5907558436891

Klucze nasadowe do sondy lambda

Oxygen sensor socket wrench / Aufsatzschlüssel für lambda-sonde / Торцевые головки для лямбда-зонда / Ключи торцевые для лямбда-зонды / Lambdasonda kulcs készlet / Chei tubulare pentru sonda lambda / Nástržné kľúčiky pro sondy lambda / Nástavcové kľúčiky na lambda sondu / Nasadni kľučiči za sondu lambda / Galvuts liambda zondi / Mucipatlis lamma zondei / Lambda sondi vöti / Ключови накрайници за лямбда сонда / Nasadni kľučiči za lambda sondu / Kľuč natikač za sonde lambda / Καρυδιά για αισθητήρα λямбда / Llave de vaso para sonda lambda / Set di bussole per sonda Lambda / Chaves articuladas para a sonda lambda / Clé à sonde lambda / Dopsleutels voor lambdasonde



1/2" x 29 x 90 mm (wycięcie 8 mm)
1/2" x 27 x 80 mm
3/8" x 7/8" x 90 mm (wycięcie 20 mm)
3/8" x 1-1/16" x 74 mm
3/8" x 7/8" x 80 mm
1/2" x 22 x 50 mm
3/8" x 22 x 31 mm

Ref.	☞	EAN
11-881	0/10	5907558436884



Odkienka w nasadkach pozwalają na montaż bez demontażu przewodów

Nasadki pasują do popularnych aut osobowych poruszających się po europejskich drogach
Open-sided for lambda probe fitting without the removal of cables

The sockets fit popular European cars

Благодаря отверстиям в головках, отсутствует риск повреждения топливных трубок
Головки подходят для обслуживания большинства автомобилей, передвигающихся по европейским дорогам



Nasadka końcowej sondy lambda (gorącej) / The socket for end lambda probes (hot) / Головка для горячего лямбда-зонда 1/2", 22 mm x 50 mm

Nasadka czujnika podciśnienia i sondy lambda (do sond nisko osadzonych) / The socket for end lambda probes (hot) / Головка для горячего лямбда-зонда 3/8", 22 mm x 30 mm

Nasadka czujnika podciśnienia i sondy lambda / The socket for vacuum sensor and lambda probe / Головка для датчика вакуума и лямбда-зонда 3/8", 22 mm x 80 mm

Ref.	☞	EAN
11-203	0/20	5907558416763

Klucz do sondy lambda

Oxygen sensor socket wrench / Schlüssel für lambda-sonde / Ключ для лямбда-зонда / Ключ до лямбда-зонды / Lambdasonda kulcs, rövid / Cheie pentru sonda lambda / Kľuč na lambda sondy / Kľuč na lambda sondu / Kľuč za sonda lambda / Raktas liambda zondi / Lambda zondes atslēga / Lambda sondi vöti / Ключ за лямбда сонда / Kľuč za lambda sondu / Kľuč za sondu lambda / Кљечји αισθητήρα λямбда / Llave para sonda lambda / Set di bussole per sonda Lambda / Chave para a sonda lambda / Sleutel voor lambdasonde

Nasadka do długich sond lambda i tam gdzie złącze przewodów nie pozwala na zastosowanie typowej nasadki do sond z szczelną

The socket is suitable for long lambda probes and wherever cable connectors do not allow for using typical probe sockets with a gap

Головка для снятия длинных датчиков кислорода, а также для работы в местах, в которых невозможно использовать типовую головку для лямбда-зонда с зазором



Ref.	W [mm]	☞	EAN
11-204	22	10/10	5907558416749



Nasadka do krótkich sond lambda

The socket is suitable for short lambda probes

Головка для коротких лямбда-зондов



Ref.	W [mm]	☞	EAN
11-205	22	10/50	5907558416756



Frezy do czyszczenia gniazd wtryskiwaczy

Diesel injector seat cleaning / Fräsen zur Reinigung von Einspritzbuchsen / Набор для чистки посадочных мест дизельных форсунок / Набор для чищення посадкових місць дизельних форсунок / Injektor fészek maró és tisztító készlet / Freze pentru curățarea prizelor injectoarelor / Frézy na čištní sedel vstříkovačů / Frézy na čištní sedel vstříkovačů / Orojce za čiščenje ležišč injektorjev / Dyzelinių purkštukų šėdu valymo įrankių rinkinys / Dizela sprauslu ligzdu tīrītāji / Pihustipesade puhastamise freesid / Фрезы за почистване на леглото на инжектори / Set za čiščenje priključka ubrizgivača / Pribor za čiščenje utičnica ubrizgivača / Set καθαρισμού υποδοχών ακροφυσίων ενυφτηρά ντίζελ / Fresas para la limpieza de las tomas de los inyectores / Frese per la pulizia delle sedi degli iniettori / Fresas para limpeza de encaixes de injetores / Kit de nettoyage pour sièges d'injecteurs / Freesstukken voor reiniging van injectie nesten



14x14mm,
15x19mm,
15.5x
15.5mm,
17x17mm,
17x17.5mm,
17x19mm,
17x19.5mm,
17x20mm,
19x21.5mm

15.5x15.5mm,
17x17mm,
17x21mm,
17.5x20.5mm



Frez do gniazd zaworowych diesel. Zawartość: frez 15 mm płaski frez uniwersalny, 17 mm frez płaski dla wtryskiwaczy, Delphi/Bosch (BMW/PSA/Renault/Ford), 19 mm Frez płaski dla wtryskiwaczy Bosch (Mercedes CRD), 19 mm Frez kątowy do wtryskiwaczy Fiat/veco, Trzpień pilotujący 19 mm HEX

Diesel injector seat cutter set 4 pcs. Edge trimming cutter 15 mm flat, universal, 17 mm flat for Delphi/Bosch injectors (BMW/PSA/RENAULT/FORD), 19 mm flat for Bosch injectors (Mercedes CRD), 19 mm angle edge trimming cutter for FIAT/IVECO, Pilot mandrel 19 mm HEX

Фреза для чистки седел дизельных форсунок. В комплекте: плоская фреза 15 мм - универсальное применение, 17 мм плоская фреза для Delphi/Bosch (BMW/PSA/Renault/Ford), 19 мм плоская фреза для Bosch (Mercedes CRD), 19 мм угловая фреза для Fiat/veco, держатель - направляющая 19 мм HEX

Ref.	☞	EAN
11-218	0/20	5907558420401

Ściągacze do wtrysków z młotkiem bezwładnościowym

Fuel injector extractor service set / Abzieher für Einspritzungen mit Trägheitshammer / Комплект для снятия дизельных форсунок с обратными молотками / Комплект знімачів форсунок зі зворотним молотками / Befestekendzőfej kihúzó készlet csúszó kalapáccsal / Instalații de decapare pentru injectori cu ciocan inertial / Sada na vstřikovače s reverzním kladivem / Stahovávky vstřikovačů so zotrvačným kladivom / Izvekači za injektorje z inercijskim kladivom / Dizelini purkštukų neimimo kompleksas su atbuliniu plaktuku / Dizela sprauslu noņēmuju komplekts ar inerces āmuru / Kütusepühisti tõmmitsad, inertshammriga / Инструмент скоба обратен чук за вадене на диозу / Skidaići za ubrizgivače s inercijskim čekićem / Komplet atlaski za skidanje mlaznica sa inercijalnim čekićem / Σετ εξαγωγής ακροφυσίων συχτήρα ντιζέλ με σφαιρία αλλοθής, κεφαλές / Extractores para inyección con martillo de inercia / Estrattori per iniettori con martello inerziale / Fresas para limpeza de encaixes de injetores / Kit extractor injection diesel avec marteau coulissant / Injectietrekkers met glijhamer

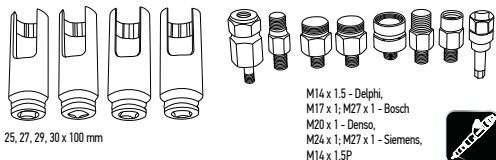

M14 x 1.5 - Delphi,
M17 x 1; M27 x 1 - Bosch
M20 x 1 - Denso,
M24 x 1; M27 x 1 - Siemens,
M14 x 1.5P



Ref.	☞	EAN
11-883	1/2	5907558435405

Zestaw do centrowania tarcz sprzęgła

Clutch center set / Zentriersatz für Kupplungsscheiben / Универсальный набор для центровки дисков сцепления / Набор универсальный для центрования дисков сцепления / Kupplungsradsca Kázpontosító készlet / Trusa de centrare a discurilor de ambreiaj / Sada pro centrování spojkových kotočů / Centrovacia súprava kotočových spojky / Kitje za centriranje plošč sklopke / Sankabos diskų centravimo rinkinys / Sajüga disku centrēšanas instrumentu universālais komplekts / Siduriketaste tsentreerimise komplekt / Комплект за центровка на съединителу / Set za centriranje ploča spojke / Pribor za centriranje diskova kvacića / Σετ κεντραρίματος δίσκων συμπλέκτη / Kit de centrado de la placa de embrague / Kit per il centraggio del disco frizione / Kit de centragem de discos de embraiegem / Kit de centreage pour disques d'embrayage

11, 12, 15, 17, 19, 20, 21, 25 mm



Ref.	☞	EAN
11-170	1/10	5907558437348

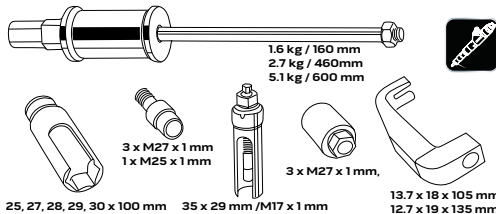

1.6 kg / 160 mm
2.7 kg / 460 mm
5.1 kg / 600 mm

3 x M27 x 1 mm
1 x M25 x 1 mm

3 x M27 x 1 mm

25, 27, 28, 29, 30 x 100 mm 35 x 29 mm / M17 x 1 mm

13.7 x 18 x 105 mm
12.7 x 19 x 135 mm



Ref.	☞	EAN
11-884	1/1	5907558435412

Ściągacz do sprzęgieł skrzyń DCT

DCT Clutch Tool / Abzieher für Doppelkupplungsgetriebe / Съемник для сцепления в коробках передач DCT / Знімач до сцеплення у коробках передач DCT / DCT váltó kúplung leszedő szerzőm / Strángere pentru ambreiajele DCT / Ppřívarek na montáž a demontáž spojky k DCT pŕevodovce / Stahovák pre spojky DCT / Orodje za sklopke DCT / Sankabos diskų neimimo įrankis DCT / Ford/Volvo DCT átrunkárbu sajüga noņēmujs / DCT-kasti sidurite tõmmits / Спецализован инструмент за монтаж/демонтаж на DCT съединителу / Alat za skidanje spojki kovčega DCT / Алатка за извлачење кутјеје квацића DTC / Εργαλείο ξεμονταρίσματος συμπλέκτη στο κιβώτιο ταχυτήτων / Tirador para embragues DCT / Estrattore frizione per cambio DCT - Ford/Volvo / Extrator de embraiegens das caixas DCT / DCT outill d'embrayage / Kraag voor DCT koppeling



Volvo: C30, C70 (06-), S40 (04-), S60 (11-), S80(07-), S80L, V40 (13-), V40 Cross Country, V50, V60, V70(08-), XC60 Ford: Focus(04-), C-Max, S-Max, Galaxy, Mondeo (07-), Kuga (13-), zamiennik / replacement / замена OEM: Volvo 9997435, Ford 308-763



Ref.	☞	EAN
11-171	1/4	5907558437379

Szczypce z linką do opasek zaciskowych

Pliers for band clips with a cord / Zange mit band für klemmschellen / Губицы зажим шлангов / Щипцы до зажимных хомутов из тросиком / Τμήλωbilinjsfogó, flexibilis / Clește cu cablu pentru brățare de strângere / Klešče s lankem na samosvorné hadicové spony / Kliešte flexibilné na hadicové spony / Klešče za objemke / Spynuoklinēs replēs svaržoms nuimti / Knaibles ar trosi savilcējiem / Trossiga klambritangid / Клепци за скобу с жупо / Klijesta s sajkom za steznu traku / Klešta za šelne sa sajkom / Εύκαμπτος σφυγκτήρας ελαστικών σωλήνων / Pinzas con cuerda para abrazaderas / Pinza per morsetti con estensione / Alicata para abraçadeiras / Pince a cable pour colliers de serrage / Tang met lijn voor klemmen

Do opasek sprężających na przewodach olejowych i wodnych etc.
Do pracy w miejscach trudno dostępnych
Długość giętkiej części: 630 mm, długość części z rekojęścią: 210 mm
Zasięg ścisła: 0 – 45 mm

For spring clips on oil and water hoses

For difficult to reach places

Flexible section length: 630 mm, handle section length: 210 mm

Clamping range: 0 – 45 mm

Для пружинных хомутов топливных, масляных и водяных шлангов и т.п.

Для работы в труднодоступных местах

Длина гибкой части: 630 мм, длина части с рукояткой: 210 мм

Диапазон зажима: 0 – 45 мм



Ref.	W [mm]	⚙	EAN
11-221	840	6/36	5907558416602

Szczypce do opasek

Clamp pliers / Zange für Kraftstoffleitungen / Щипцы для хомутов / Щипцы для шланга / Bilinjsfogó / Clește / Klešče na spony / Kliešte na hadicové spony / Klešče za vzmetne objemke / Replēs žarnelių žiedų užspaudimui / Savilcēju knaibles / Knaiblisidemetē tangid / Щипцы за проводники на горюиво / Klijesta za stiskanje / Klešta za žicu / Λοβία στεφανιών στερέωσης / Alicates para bridas / Pinza per morsetti in gomma / Pinças para abraçadeiras / Pince de serrage



Ref.	⚙	EAN
11-228	1/5	5907558437386



Ref.	⚙	EAN
11-222	0/54	5907558418545

Szczypce

Pliers / Zange / Клепци / Πασσαγοβύσι / Fogókészlet / Clește plat / Klešič / Kliešte / Klešče / Replēs / Knaiblu / Nāpītsate / Клепци / Kliešta / Klešta / Συγκροτή πεναύσι / Alicates / Pinza per morsetti / Pinças / Pince / Tangen



Ref.	⚙	EAN
11-223	6/48	5907558418552

Szczypce zaciskowe z tworzywa

Flexible line clamp / Gripzange aus Kunststoff / Набор зажимов с фиксатором / Кліпці досилени пластиком / Onzáró fogókészlet műanyag / Clește de strângere din plastic / Plastové svěráci klešič / Zvieracie plastové kliešte / Plastične klešče za preščip cevi / Replēs stabdžū šlangelēms užspaušti / Plastmasas saspiēšanas knaibles / Plastīta lukustangid / Σταθαμι κλεπци от πλαστικα / Stezna klijesta od umjetnog materijala / Plastična kliešta / Σετ σφυγκτήρες με μηχανικά ασφαλισία / Tenazas abrazaderas de plástico / Pinza occlusionista tubo in plastica / Pinças de plástico / Pince de serrage en plastique / Krimp tang van kunststof



Ref.	⚙	EAN
11-224	0/48	5907558418699

Zestaw mini szczypiec do pierścieni osadczyc

Mini pliers set for circlips / Mini-Zangenset für Stellringe / Набор щипцов для стопорных колец, "mini" / Набор минищипцов до стопорных колец / Mini pliers set for circlips / Garnitura de mini clesti pentru inele de strangere / Sada preciznich klešič na pojistné kroužky / Súprava mini kliešči na pojistné krúžky / Set mini klešč za objemke / Mini replių komplektas, fiksavimo žiedams / Sprostgredzenu knaibļu komplekts, mini / Lukustusrõngaste minitangide komplekt / Комплект мини щипцы за стопорни пръстени / Set mini seger klijesta za stiskanje i širenje / Komplet mini kliešta za taložne prstene / Σετ μικρές λαβίδες για δοκτύλια ασφαλείας / Juego de mini alicates para anillos de retención / Kit mini pinze per anelli d'arresto / Pinças para anéis / Jeu de mini-pinces pour colliers de fixation / Set van mini tangen voor dopringen



Ref.	⚙	EAN
11-227	24/48	5907558420395

Zaciskacz do pierścieni

Piston ring compressor / Ringklemme / Оправка поршневых колец / Затисачка до кільця / Dugattyúgyűrű szorító szalag / Strängåttor de inele / Svērka na kroužky / Pás na sfahovanie piestnych kružkov / Obročni prižemnik / Žeduj suspaudejas / Gredzenu saspiedējs / Vörusulgur / Стяга за пръстену / Stezaljka za prstenje / Στεζαχάς βακτηλίων εμφύλου / Compresor para anillos / Marsetto per anelli / Fixador de anéis / Colier de serrage / Ringklem



Ref.	Ra [mm]	⊖	EAN
11-250	50 - 125	0/60	5907558418330

Klucz do demontażu napinaczy z wymiennymi końcówkami

Tensioner pulley / Schlüssel zum Abbau von Spanner mit auswechselbaren Spitzen / Ключ для снятия пряднатяжителя со сменными наконечниками / Ключ для зняття пряднатягача зі змінними наконечниками / Feszítőgörgő kulcs cserélhető fejekkel / Cheia pentru demontarea întinzătoarelor cu capete interschimbabile / Klíč na demontáž napínací kladyk s výměnitelnými koncovkami / Ključ za odstranitev napinčalnikov z izmenljivimi konci / Raktas įtempiklų pakeitimui, su keičiamais antgaliais / Priekšspriegātoja demontāžas atslēga ar maināmajiem galotiem / Pinguļtie veidotājamise vādi, vaihātatavāte oīskāteļa / Ключ за демонтiranje на обтяжени ролни със сменяеми накрайници / Ključ za demontažu zatežaca sa izmenljivimi nastavcima / Ključ za demontiranje zatežaca sa promenljivim krajevima / Ключи αφαιρέσης προεντατήρων με ανταλλακτικές μύτες / Llave para quitar los tensores con puntas intercambiables / Chiave per smontaggio dei tenditori con punte intercambiabili / Chave para desmontar tensores com pontas substituíveis / Clé de démontage des détecteurs avec embouts interchangeables / Sleutel voor demontage van spanners met eindstukken

12, 13, 14, 15, 16, 17, 18, 19 mm

E10, E12, E14, E16, E18



Ref.	⊖	EAN
11-169	0/10	5907558437331

Klucz do napinania pasków klinowych

Transmission belt tensioning wrench / Schlüssel zum Spannen von V-Spanngurten / Ключ для затягивания клиновых ремней / Ключ для затягування клинових пасів / Ekszjű feszítő kulcs / Cheie pentru strângerea curelei trapezoidale / Klíč k napínání řemenice / Ključ na uťahovanie klinových reťenov / Ključ za napenjanje klinastege jermena / Pleištinijū diržų užvertimo raktas / Transmisijas siksnas pievilkšanas atslēga / Kiilrihmade pingutamise vāti / Инструмент за натягане на клинов ремь / Ključ za naprežanje remena / Ključ za zatežanje klinastih reţenova / Ключи танауаής αφροειδών ιµάντων / Llave para apretar las correas / Chiave per il tensionamento di cinghie dentate / Chave para tensionar correias / Clé pour tendre des courroies / Spanner voor V-snaar



Ref.	⊖	EAN
11-168	1/6	5907558437324

Zestaw do alternatora

Combined sockets for alternator / Lichtmaschinen-Schlüsselsatz / Набор для альтернатора / Набор до генератора змінного струму / Készlet generátor szereléshez / Set de alternator / Sada na alternatory / Súprava pre alternátor / Set za alternator / Rinkinyės kintamosios srovės generatoriui / Mainstāvās ģeneratora instrumentu komplekts / Generatori padrūnāvētme komplekt / Комплект за алтернатора / Garnitura za alternator / Garnitura za alternator / Σετ για εναλλακτήρα / Juego para alternador / Kit per montaggio e smontaggio alternatori / Jogo de acessórios para alternador / Kit d'alternateur / Set voor wisselstroomgenerator

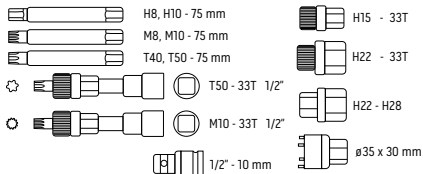

Ref.	⊖	EAN
11-167	1/10	5907558437317

Zestaw do układów ciśnienia/podciśnienia

Tester for vacuum and pressure systems / Satz für Druck-/Vakuumsysteme / Набор для напорных / вакуумных систем / Набор для напірних/вакуумних систем / Vákuum és nyomás tesztelő / Set pentru sisteme de presiune / vid / Tester pro tlakové/podtlakové systémy / Súprava pre tlakové / podtlakové systémy / Set za vakuumske in tlačne sisteme / Rinkinyės slėgio / vakuuma sistemoms / Spiediena/vakuuma sistēmu instrumentu komplekts / Rõhu-/vaakumsüsteemide komplekt / Πомпа за течащие на вакуум и налягане / Set za sustave tlaka/podtlaka / Pribor za sistem pritiska/vakuuma / Σετ για απίτηματα κενού αέρος/ναρικής/υπό πίεση / Prbadar de sistemas de presión / vacío / Kit per impianti a pressione/in depressione / Kit para sistemas de pressão/subpressão / Testeur de pression / compression / Meter voor druk/onderdruk systemen



Ref.	⊖	EAN
11-267	1/10	5907558436013

Zestaw do diagnostyki systemów Common Rail

Common Rail diagnostic set / Diagnossatz für Common-Rail-Systeme / Набор для диагностики систем Common Rail / Набор для диагностики систем комон-рейл / Common rail rendszer diagnosztikai készlet / Trusť za diagnostickerea sistemelor Common Rail / Sada pro diagnostiku systémů Common Rail / Sada pre diagnostiku systémov Common Rail / Set za diagnostiku sistemov Common Rail / Diagnostikos rinkinys, skirtas sistemai Common Rail / Common Rail sistėmu diagnosticėšanas komplekts / Common Rail sistėmeide diagnostikakomplekts / Комплект за диагностика на систему Common Rail / Set za dijagnostiku sustava Common Rail / Prior za dijagnostiku sistema Common Rail / Διαγνωστικό σετ για συστήματα Common Rail / Set para diagnóstico de sistemas Common Rail / Kit diagnostic per sistemi Common Rail / Kit de diagnóstico de sistemas Common Rail / Kit de diagnostic pour systèmes Common Rail / Common Rail diagnostische set



BOSCH
SIEMENS
DENSO
DELPHI

MADE IN
POLAND

Ref.	☞	EAN
11-263	1/5	5907558435979

Miernik ciśnienia sprężania diesel

Compression pressure in a diesel engine / Verdichtungsdruckmesser dielemotor / Изм давления компресси в дизел двигателе / Компресометр для дизелньх двигателей / Kompresszió mérő- diesel / Aparat de măsurat compresa diesel / Sada na seřizování vstřikovacích trysek dieselových motorů / Merač kompresného tlaku na dieselových motoroch / Merilec pritiska diesel / Dizelinis kompresijos matuoklis / Kompresijas manometers, dielemotoriem / Manometer diesel / Компресометр за дизелови двигатели / Mjerač kompresije diesel / Merač pritiska sabijanja dizel / Μητρική συσκευή κιντήρα ντιζελ / Medidor de aire comprimido diesel / Misuratore pressione di compressione diesel / Medidor de pressão de compressão diesel / Compressiometre diesel / Meter van persdruk diesel

70
BAR x16
DIESEL



Miernik kompresji do pomiarów ciśnienia sprężania w cylindrach silników wysokoprężnych (diesel)
Zestaw zawiera różne adaptery pasujące do większości silników aut osobowych i dostawczych
Maksymalny zakres pomiaru – 70 barów

Pressure gauge for measuring compression pressure in diesel engine cylinders
The set includes various adapters suited for a majority of passenger and delivery vehicle engines
The maximum measurement range – 70 bars

Компресометр для измерения давления в дизельных двигателях
В комплект входит адаптеры, которые подходят к большинству двигателей легковых и грузовых автомобилей
Диапазон измеремого давления – до 70 бар

Ref.	☞	EAN
11-262	0/6	5907558416732

Zestaw do testowania systemów wtryskowych

Fuel injection injector pressure test set / Testsatz für Einspritzsysteme / Набор для проверки форсунок впрыска топлива / Набор для проверки форсунок впрыскивания топлива / Befecskendőz rendszer tesztelő készlet / Set pentru testarea sistemelor de injectie / Sada pro testování vstřikovacích systémů / Súprava na testovanie vstrekovacích systémov / Set za testiranje injektorških sistemov / Įprškimo sistėmu testavimo rinkinys / Degvielas iesmidzināšanas sprauslas pārbaudes instrumentu komplekts / Sissepritesüsteemide testimise komplekt / Комплект за диагностика на инжекционни системи / Set za ispitivanje sustava ubrizgivanja / Sistem za testiranje sistema za ubrizgovanje / Σετ ελέγχου ακροφυσίου έκχυσης καυαίου / Kit para pruebas de sistemas de inyección / Kit per il test di sistemi di iniezione / Kit de testagem de sistemas de injeção / Kit d'essai pour systèmes à injection / Brandstoffinjektor test set



MADE IN
POLAND

0-10
BAR

Ref.	☞	EAN
11-264	1/5	5907558435986

Miernik ciśnienia sprężania

Compression tester / Verdichtungsdruckmesser / Компресометр бензиновый / Компресометр / Kompresszió mérő / Aparat de măsurat compresa / Měřicí přístroj kompresního tlaku / Merač kompresného tlaku / Merilec pritiska adapter / Kompresijos matuoklis / Kompresijos manometers / Manometer adapterite komplekt / Mjerač pritiska / Merač pritiska sabijanja / Συμπεριέκτηρο βενζίνης / Medidor de aire comprimido / Misuratore della compressione / Medidor de pressão de compressão / Compressiometre compression / Meter van persdruk

21
BAR



Miernik kompresji do pomiarów ciśnienia sprężania w cylindrach silników spalinowych benzynowych
Zestaw zawiera adapter pasujący do większości silników aut osobowych i dostawczych
Maksymalny zakres pomiaru – 21 barów

Compression pressure gauge for measuring compression pressure in petrol combustion engine cylinders
The set includes an adapter suited for a majority of passenger and delivery vehicles
The maximum measurement range is – 21 bars

Компресометр (тестер давления) для измерения давления в бензиновых двигателях
В комплект входит адаптер, который подходит к большинству двигателей легковых и грузовых автомобилей
Диапазон измеремого давления – до 21 бар

Ref.	☞	EAN
11-261	0/20	5907558416725

Tester ciśnienia turbospężarki

Turbo pressure gauge / Druckprüfgerät für Turbolader / Тестер турбо давления / Тестер тиску у турбокомпресорі / Turbófeltöltő nyomás tesztelő / Tester de presiune turbocompresor / Manometr pro kontrolu tlaku turba / Tester tlaku turbodúchadla / Preskuševalnik tlaka turbo kompresorja / Turbokompresoriy testavimo rinkinys / Turbo spiediena mēriņš / Turboladuri gāhu tester / Тестер за налягане на турбокомпресор / Tester pritisaka u turbokompresoru / Tester za pritisak turbokompresora / Ελεγκτής πίεσης turbo / Probador de presión para turbocompresor / Tester di pressione per turbocompressor / Aparelho de teste de pressão de turbocompressor / Testeur de pression d'huile turbocompresseur / Turbokompresor druk meter



-1 ÷ 3
BAR

Ref.	⊞	EAN
11-265	1/10	5907558435993

Tester ciśnienia oleju

Engine oil pressure tester / Druckprüfgerät für Öldruck / Тестер давления масла / Тестер тиску оливи / Olajnyomás tesztelő / Tester de presiune ulei / Tester tlaku oleje / Tester tlaku oleja / Preskuševalnik tlaka olja / Tepalo slęgia matuoklis / Είλας spiediena mēriņš / Ötirdühu tester / Тестер за налягането на маслото / Tester pritisaka ulja / Tester za pritisak ulja / Ελεγκτής πίεσης λαδιού / Probador de presión del aceite / Tester di pressione dell'olio / Aparelho de teste de pressão de óleo / Testeur de pression d'huile / Motorolie druk meter

0-10
BAR



Ref.	⊞	EAN
11-266	1/2	5907558436006

Zestaw kluczy nasadowych do filtra oleju

Cap type oil filter wrench set / Steckschlüsselsatz für Ölfilter / Набор торцовых ключей и масляного фильтра / Набор накидных ключей до оливного фильтра / Dugökules-készlet olajsűrűzőhöz / Set de chei tubulare pentru filtru de ulei / Sada miskovitých klíčů na olejový filtr / Sůprava nástavcových klíčův na olejový filtr / Set nasadnih ključev za oljni filter / Galvušų rinkinys tepalo filtrui / Eļlas filtra mucipatslęgu komplekts / Ūīļfiltru padrunvōmete komplekts / Комплект гаечни ключове за масления филтър / Garnitura nasadnih ključeva za filter ulja / Garnitura ključeva natikača za filtere za ulje / Zet προσολοκκίδα για φίλτρο λαδιού / Juego de llaves de vaso para filtro de aceite / Completo di chiavi a bussola per il filtro dell'olio / Jogo de chaves tubulares para filtro de óleo / Jeu de clés à douille pour filtre à huile / Set van dopstels voor oliefilter



x30



x16

⊞	⊞ mm	⊞ N	🚗
66/6	66	6	Fiat Punto 1,2; Renault Clio 1,2; Rapid; Tingo
65/14	65	14	Daihatsu; Toyota; Nissan; Fiat; Camry
65/67	65-67	14	Daihatsu; Toyota; Mazda; Mitsubishi
68/14	68	14	Mazda; Ford; Subaru; Toyota
73/14	73	14	Toyota; Lexus
74/15	74	15	Audi; Rover; Chrysler; Lotus; GM
74/76	74-76	15	Ford; Opel; VW; Audi; Mercedes; GM
75/77	75-77	15	VW; Audi; Isuzu; Mercedes; GM; Chrysler
76/12	76	12	Fiat; Mercedes; Renault
76/14	76	14	VW; Porsche; Mercedes; BMW; Audi; Opel; Butek
76/30	76	30	Ford; VW; Renault; Peugeot
76/8	76	8	Fiat; Lancia
78/15	78	15	Nissan; Ford; Toyota
80/15	80	15	Nissan; Honda; Opel; Mazda; Iveco

⊞	⊞ mm	⊞ N	🚗
80/82	80	15	Subaru; Toyota; Honda; Nissan; Iveco; Hyundai; Mazda
80/16	86	16	Volvo
86/18	86	18	VW Golf; Audi A6 TDI; Peugeot; Citroen
90/15	90	15	Honda; Mitsubishi; Isuzu; Mazda
92/70	92	10	Fiat
93/15	93	15	Mazda; Volvo; Mitsubishi; Nissan; Honda
93/36	93	36	Ford; Audi
93/45	93	45	VW; Audi TDI
95/15	95	15	Toyota; Alfa Romeo; Ford
96/18	96	18	Audi A4; A6 TDI; VW Passat TDI; Renault Laguna
100/15	100	15	Isuzu; Mitsubishi; Butek; Hyundai; Iveco; Daewoo; Renault
106/15	106	15	Fiat Ducato
108/15	108	15	Volvo
108/18	108	18	Renault Espace; Laguna; Safrane; Traffic

Ref.	Ra[mm]	⊞	EAN
11-242	66-108	1/2	5907558435955

Ref.	Ra[mm]	⊞	EAN
11-243	65-100	1/10	5907558435962

Nasadka do filtra oleju

Сир type oil filter wrench / Ölfilterkappen / Съемник масяного филтъра "чашка" / Знімач масяного филтъра "чашка" / Csésze olajszűrő lehéző / Сирѝ филтра де улеи / Stahovák olejového filtru / Ključ za olejovu filter / Ključ za oljni filter / Raktas tepalo filtrui / Atslēga eļļas filtram / Ölfilteri vāti / Водяца шина за дража / Кљуц за улјни филтер / Кљуц за улјни филтер / Клеиѝ филтρου лаѝиѝ / Llave para filtro de aceite / Chiave per il filtro dell'olio / Chave p. filtros de óleo / Clef à filtre d'huile / Sleutel voor oliefilter



3/8"

Ref.	Ø mm	Ø	Ø	EAN
11-360	76	12	10/60	5907558445299
11-361	65	14	10/60	5907558445305
11-362	67	14	10/60	5907558445312
11-363	73	14	10/60	5907558445329
11-364	76	14	10/60	5907558445336
11-365	74	15	10/60	5907558445343
11-366	78	15	10/60	5907558445350
11-367	80	15	10/60	5907558445367
11-368	90	15	10/60	5907558445374
11-369	95	15	10/60	5907558445381
11-370	108	15	10/60	5907558445398
11-371	86	16	10/60	5907558445404
11-372	86	18	10/60	5907558445411
11-373	96	18	10/60	5907558445428

Zestaw do misek oleju

Oil change tool kit / Ölwechsel-Werkzeugsatz / Набор инструментов для замены масла / Набор инструментов для замены масла / Küllönleges szerszámkészlet olajcseréhez / Trusă de scule specială pentru schimbul de ulei / Speciální sada nářadí pro výměnu oleje / Speciální sada nářadí na výměnu oleje / Orodje komplet posebnih za menjavo olja / Įrankių rinkinys specialus alyvos keitimui / Įrašs instrumentu komplekts eļļas maiņai / Τοορισιακιμπλεκσιτς σπιςιαινε ολιβαηηησεκς / Комплект инструментов за смяна на масло / Komplet alata poseban za zamenu ulja / Комплект алата специјални за замену уља / Ειδικιτι κσιρραλισην για αλλαγη λαδιου / Kit de herramientas especial para cambio de aceite / Kit attrezzi speciali per cambio olio / Kit de ferramentas especial para troca de óleo / Kit d'outils spécial pour le changement d'huile



5 ELEMENTS

1/4"

3/8"

Audi / SEAT / Škoda / VW:
model year 2013 with 1.2 - 1.4 - 1.8 - 2.0 l TFSI petrol engines
Audi: A1, A3, A4, A5, Q5
VW: Golf 7
SEAT: Leon, etc. with 1.6 and 2.0 l diesel engines

OEM: Connect 31775 Peugeot/Citroen (OEM 980 1444780 Plug) and Ford (OEM 18711598 plug) Connect 31776 Ford (OEM 1830727 plug) Connect 31774 BMW (OEM 1137605018 plug) Connect 31771 VAG (OEM 06L 103 801 sump and cam cover plug)

Ref.	Ø	EAN
11-384	5/20	5907558452273

Końcówka wkrętakowa do korków oleju

Special bit for oil drain plug / Spezial Bit für Ölablassschraube / Бита специальная для сливной пробки / масяного под / Бита для сливной пробки / Bit az olajdugókhöz / Bit special pentru dopul de scurgere a uleiului / Specialni bit pro vypuštění zátke oleje / Specialny bit pre vypúšťaciú zátku oleja / Poseben bit za zamašek za izpust olja / Specialus antgalis alyvos išleidimo kamščiu / Įrašs bit eļļas iztukšošanas aizbāžnei / Spetsiaalne ots õli väljalasketruvi jaoks / Ключ за маслену тачу / Кљуц за тачево за улје / Кљуц за ченове за уље / Клеиѝ για βιολατα λαδιου / Llave especial tapón de aceite / Chiave speciale per tappi olio / Chave especial para óleo / Clé à bouchon d'huile spéciale / Speciale olieplugsleutel /



1/4"

Audi / SEAT / Škoda / VW:
model year 2013 with 1.2 - 1.4 - 1.8 - 2.0 l TFSI petrol engines
Audi: A1, A3, A4, A5, Q5
VW: Golf 7
SEAT: Leon, etc. with 1.6 and 2.0 l diesel engines

Ref.	Ø	EAN
11-383	20/100	5907558452266

Klucze do spustu oleju

Oil drainer set / Ölablassschlüssel / Ключи для слива масла / Ключи для зливання оливи / Olajleereszt kulcs készlet / Chi pentru dop de scurgere a uleiului / Ключе на врпушени олеје / Sada klúčov na vypúšťanie oleja / Vjaki za spuščanje olja / Raktai alyvos išleidimui / Eļļas nalaīšanas atslēgas / Ölirtorgi vātdme / Ключове за источване на масло / Кјуѝчеви за испуштане улја / Кјуѝчеви за испуштане улја / Σετ αποστράγγισης λαδιου / Llavas para evacuación de aceite / Insetti per tappo olio / Chaves para evacação de óleo / Clés pour la vidange d'huile / Sleutels voor olie drainage



25 years GUARANTEE

CrV steel

3/8" x18



Zastosowanie / Application / Применение:

Hex 8 mm: BMW, Ford, GM
Hex 9 mm: GM
Hex 10 mm: Ford
Hex 12 mm: Fiat, Lancia, Peugeot
Hex 14 mm: Lancia, Mercedes
Hex 17 mm: Audi, VW, BMW, Austin
Square 7, 8 mm: Citroen, Peugeot, Renault, Talbot, Volvo
Square 11 mm: Ford
Square 13.1 mm: Nissan, Subaru
Square 3/8": Honda, Mazda, Renault, Saab, Volvo
Square (5/16), 10 mm Female, Square: 10 mm: do skrzyń biegów i mechanizmów dyferencyjnych różnych marek auto np. / for gearboxes and differential mechanisms of various makes / для коробки передач и дифференциала автомобилей разных марок: BMW, Ford, Renault, Toyota
Triangular: 10 mm Renault
M16 Spline (Tamperproof): Audi A4 1A6



Ref.	Ø	EAN
11-235	0/10	5907558417098

Klucz do filtra oleju

Oil filter wrench / Schlüssel für Ölfilter / Съёмник масляных фильтров / Ключ для масляных фильтров / Olajsűrő leszedő / Cheie pentru filtre de ulei / Klíč na olejový filtr / Ključ na olejový filter / Kjuč za oljni filter / Raktas tepalo filtrui / Eljas filtru atslėga / Ölfiltrivöti / Ключ за маслен филтър / Ključ za filter za ulje / Κλειδί αφαίρεσης φίλτρου λαδιού / Llave para filtros de aceite / Chiave per filtro olio / Chave para filtros de óleo / Cle filtre a huile / Filtersleutel



Ref.	Ra[mm]	Ø	EAN
11-237	43-102	1/40	5907558437355



Ref.	Ra[mm]	Ø	EAN
11-239	64-100	1/40	5907558435924



Ref.	Ra[mm]	Ø	EAN
11-238	64-120	1/40	5907558437322

Klucz łańcuchowy

Chain wrench / Kettenschlüssel / Цепной ключ / Ключ ланцюговий / Láncos csőfogó / Cheie cu lanț / Ρετζόνυ κλιζ / Ρελαζόνυ κλιζ / Verižni kjuč / Grandininis raktas / Kėdes atslėga / Kettvöti / Вержен ключ / Lančani kjuč / Lančani kjuč / Κλειδί αλυσίδας / Llave de cadena / Chiave a catena / Chave de corrente / Clef à chaîne / Kettingsleutel



60-115 mm



1/2"

Ref.	Ra[mm]	Ø	EAN
11-381	60 - 115	5/20	5907558445459



60-160 mm



Ref.	Ra[mm]	Ø	EAN
11-382	60 - 160	6/24	5907558445466



20°

Ref.	Ra[mm]	Ø	EAN
11-240	63.5 - 116	6/36	5907558435931



30°
60°
90°

Ref.	Ra[mm]	Ø	EAN
11-241	63.5 - 116	5/30	5907558435931



Ref.	Ra[mm]	Ø	EAN
11-231	73 - 85	6/36	5907558416657

Automatyczny klucz do filtra oleju

Automatic oil filter wrench / Schlüssel für Ölfilter / Съёмник масляного фильтра / Ключ до масленого филтър / Olajsűrő leszedő / Cheie pentru filtrul de ulei / Klíč na olejový filtr / Ključ na olejový filter / Kjuč za oljni filter / Raktas tepalo filtrui / Atslėga eljas filtram / Ölfiltrivöti / Водещи щипка за дрoза / Kjuč za oljni filter / Ključ za uljani filter / Κλειδί φίλτρου λαδιού / Llave para filtro de aceite / Chiave per il filtro dell'olio / Chave p. filtros de óleo / Clef à filtre d'huile / Sleutel voor oliefilter



80-115 mm



Ref.	Ra[mm]	Ø	EAN
11-380	80 - 115	1/20	5907558445442

Odciągarka do oleju

Oil suction gun / Ölabzieher / Отсосное устройство для масла / Oliivoiväimäytin / Olajfejzáló / Trägator de ulei / Odsávnačka oleje (ruční) / Odsávnačka na olej / Črpalčka za olje / Alyvos siurblys / Eļlas atvilcējs / Ölístalt / Засмолювачка маслена помпа / Sisäljka za ulje / Pumpa za ispuumpavanje ulja / Αναρροητήρας λαδιού / Dispositivo de extracción de aceite / Pistola di aspirazione olio / Máquina de remover óleo / Vidangeur d'huile / Oliefzuiger



Ref.	[ml]	Ø [mm]	L [mm]	⊘	EAN
11-510	500	56,4	280	0/20	5907558415346
11-511	1000	62,5	400	0/10	5907558415353



METAL

280 mm

Wanna do oleju

Oil drain bucket / Ölwanne / Ванночка для масла / Ванна олієна / Olajkád / Baie de ulei / Vana na olej / Vaňa na olej / Posoda za olje / Vanelē teraļli / Ванна еļļай / Ölvann / Vana za maslo / Posoda za ulje / Kada za ulje / Λεκάνη αποστράγγισης λαδιού / Bandeja para aceite / Contenitore olio / Bandeja para troca de óleo / Bac à huile



Ref.	⊘	EAN
11-550	0/10	5907558415360

7 dm³

PLASTIC

Lejek

Funnel / Trichter / Воронка / Воронка / Tölcsér, flexibilis, szűrével / Pálieň / Nálevka / Lievik / Lijak / Piltuvēlis / Piltuve / Lehter / Фуния / Lijevak / Levak / Xavi / Embudo / Imbuto / Funil / Entonnoir / Trechter



Ref.	Ø ₁ [mm]	Ø ₂ [mm]	⊘	EAN
11-555	45	160	0/6	5907558436396

1,2 L HDPE LDPE

Kanister na benzynę

Can for petrol / Benzinbehälter / Kanistera dla benzyna / Kanistera dla benzynu / Üzetaşmayacağına, mülayag / Bidon de benzina / Kanistr na benzin / Kanistra na benzin / Kanister za bencin / Bakas benzini / Benzina kann / Bensinikanister / Бүдөн за бензин / Kanister za benzin / Kanta za benzin / Кánстра бензин / Bidón para gasolina / Tanica per la benzina / Tanque para gasolina / Jerrycan à essence / Jerrycan voor benzien



Ref.	V [l]	⊘	EAN
11-560	10	0/50	5907558436402
11-561	20	0/30	5907558436419

HDPE PP LDPE

Klucz do kół

Wheel wrench / Radschlüssel / Ключ для колес / Ключ для монтажу кіл автомобільних / Kereszt kerékkulcs / Cheie piliuță p/u demontarea și montarea roților / Klíč na kola / Ključ na kolesa teleskopický / Ključ za avtomobilska kolesa / Raktas ratams / Ritepu atslēga / Rattavöti / Ключ за зуми / Ключ за kotač / Ključ za točak / Клеџи за трaкoуџ / Llave extensible para ruedas / Chiave a croce / Chave para filtro / Clef pour filtre / Wielseutel

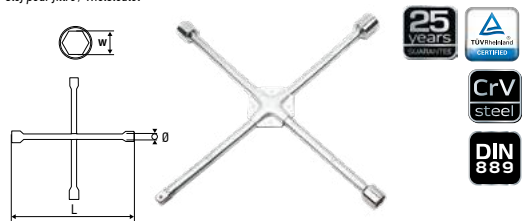

Ref.	W	ø [mm]	L [mm]	⊘	EAN
11-100	17x19x22x1/2'	16	355	0/16	5907558412864

25 years GUARANTEE



CrV steel

DIN 889



Ref.	W	ø [mm]	L [mm]	⊘	EAN
11-102	24 x 27 x 32 mm, 3/4"	22	700	0/4	5907558418309

25 years GUARANTEE



CrV steel



Ref.	W	⊘	EAN
11-101	17x19x1/2'	6/12	5907558417135

25 years GUARANTEE



CrV steel

1/2"

Ściernice do czyszczenia piast

Wheel hub grinder Schleifmittel zur Reinigung von Naben / Шлифовальные круги для очистки ступицы / Шлифовальні круги для очищення моточин / Kerékagy tisztító dörzstárcsa / Discuri pentru curățarea buțucilor / Brusné kotouče pro čištění nábojů / Brusné kotouče na čistenie nábojov / Brusi za čiščenje pest / Frankiai ratų stebulių valymui / Ritepa rumbas tirišanas slīpdiski / Rataste puhastamise lihkkestid / Почистовачи четки за главници / Diskovi za čiščenje glavnice / Brusione ploče za čiščenje čvorštitu / Трохои клявоњы за καθαράσηση πλήνης τροχού / Amoladora para limpiar cubos de ruedas / Dischi abrasivi per la pulizia di mozzi / Escovas circulares para limpeza de cubos de rodas / Meules pour nettoyage des moyeux / Wielnaaf grinder voor reiniging

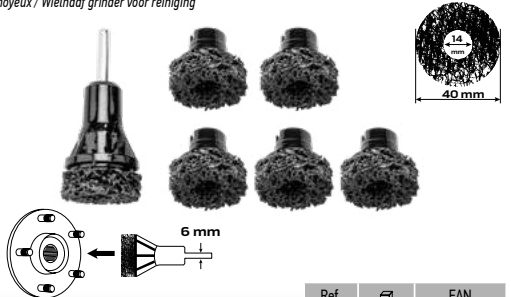

Ref.	⊘	EAN
11-135	25/50	5907558437287

NEO TOOLS

NARZĘDZIA WARSZTATOWE

WORKSHOP TOOLS

ИНСТРУМЕНТЫ МАСТЕРСКОЙ

Separator

Spreader / Abscheider / Съемник / Сепаратор / Fékünkahenger visszaszámó tárcsafékhöz / Separator / Separator / Separator / Separator / Separator / Separator / Separator / Separator / Separator / Separator / Διαχωριστής / Separador / Separatore / Separador / Séparateur / Separator

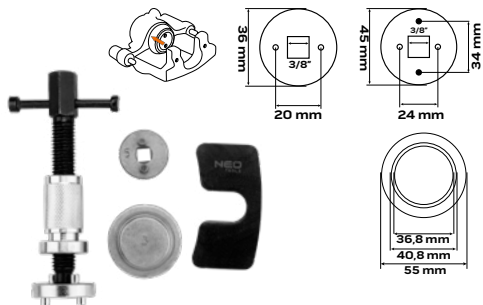

Ref.	Ra[mm]	☞	EAN
11-125	35-90	5/20	5907558437218

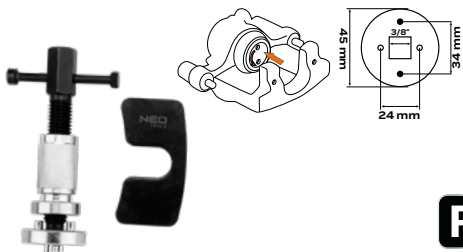

Ref.	Ra[mm]	☞	EAN
11-126	25-60	5/20	5907558437232

R



Ref.	Ra[mm]	☞	EAN
11-127	25-60	5/20	5907558437232

L



Ref.	Ra[mm]	☞	EAN
11-128	40-70	1/20	5907558437249

Separator pneumatyczny z końcówkami

Air brake caliper wing tool / Einstellwerkzeug für pneumatische Bremszylinder / Инструмент регулировки пневматического тормозного цилиндра / Инструмент регулювання пневматичного гальмівного цилиндра / Pneumatikus fékhenger beállító eszköz / Instrument de réglare a cilindrilor de frână pneumatic / Nástroj pro seřízení pneumatického brzdového válce / Nástroj na nastavenie pneumatického brzdového valca / Orodje za nastavitve pnevmatičnega zavrnega valja / Pneumatiline pidurisilindri regulavimio irankis / Pneumatiskis Bremžu cilindra regulēšanas rīks / Pneumatiline pidurisilindri regulierimise tööriist / Пневматичен инструмент за регулиране на спиратичен цилиндър / Alat za podševavanje pnevmatskog kočnog cilindra / Alat za podševavanje pnevmatskog kočnog cilindra / Εργαλείο ρύθμισης κυλίνδρου πετσεμένου αέρα / Herramienta de ajuste del cilindro de freno neumático / Strumento di regolazione del cilindro del freno pneumatico / Ferramenta de ajuste de cilindro de freio pneumático / Outil de réglage du cylindre de frein pneumatique / Luchtremklaus vliegtel gereedschap



Ref.	☞	EAN
11-132	0/5	5907558445435

16
ELEMENTS

(L/R)

1/4"

Zestaw ręcznych separatorów do zacisków hamulcowych

Set of hand separators for brake calipers / Bremsskolbenrückstellersatz / Комплект приспособлений для обслуживания тормозных цилиндров / Набор ручных сепараторів для гальмівних колодок / Tárcsafék szerelő és visszaszámó készlet / Set manual de separatori la cleme de frână / Sada na montáž kotúčových brzd / Súprava na montáž kotúčových brzd / Set ročnih ločevalnikov zavornih batov / Stabdzių cilindrų suspaudimo komplektas / Bremžu cilindru manūolo separatoru komplekts / Piduriklotside separatorite komplekt / Комплект ручни сепаратори за спиратичне клеми / Set ručnih odvajača za kočione stezaljke / Pribor ručnih sепаратора за kočione stezaljke / Set αυτιήρησες κυλίνδρων πέδησης / Juego de separadores manuales para las pinzas de freno / Utensili per il riposizionamento dei pistoncini dei freni / Jogo de separadores manuais para maxilas de travão / Jeu de séparateurs manuels pour étriers de freins / Set voor handmatige afstanders voor remklemmen



Ref.	☞	EAN
11-129	1/5	5907558437256

x35

Zestaw ręcznych separatorów do zacisków hamulcowych

Set of hand separators for brake calipers / Bremskolbenrückstellersatz / Комплект приспособлений для обслуживания тормозных цилиндров / Набор ручных сепараторов для тормозных колодок / Társcsafék szerelő és visszatartó készlet / Set manual de separatori la cleme de frână / Sada na montáž kotoučových brzd / Súprava na montáž kotúčových brzd / Set ročnih ločevalnikov zavornih batov / Stabžičiu cilindru suspaudimo kompleksas / Bremžu cilindru maņiolo separatoru komplekts / Piduriklotside separatorite komplekt / Комплект ручни сепаратори за спрочачиме кнеми / Set ručnih odvajača za kočione stezaljke / Pribor ručnih separatora za kočione stezače / Σετ αντήρησης κυλινδρών πέδησης / Juego de separadores manuales para las pinzas de freno / Utensili per il riposizionamento dei pistoncini dei freni / Jogo de separadores manuais para maxilas de travão / Jeu de séparateurs manuels pour étriers de freins / Set voor handmatige afstanders voor remklemmen



Ref.	📦	EAN
11-123	0/10	5907558419993



Ref.	📦	EAN
11-122	0/5	5907558419986

Zestaw do montażu szcęk hamulcowych

Tool kit for brake shoe fitting / Bremsbacken-Montagewerkzeugsatz / Инструмент для обслуживания тормозной системы / Набор для монтажа тормозных колодок / Férfokészlet a fékcsákhoz / Set pentru montarea sabotilor de frana / Sada na montáž brzdových čelistí / Súprava na montáž brzdových čelistí / Set za montažo zavornih čeljusti / Stabžičiu trinkelju montavimo rinkinys / Bremžu uzliuku turētāju montāžas komplekts / Pidurikingade paigaldāmis komplekts / Комплект за монтажу на спрочачиме челистима / Set za montažo kočionih čeljusti / Pribor za montažo kočionih čeljusti / Εργαλεία συντήρησης συστημάτων πέδησης / Kit de montage de mordazos de frenos / Kit per montaggio pinze del freno / Jogo de ferramentas para montagem de maxilas de travão / Jeu d'outils de montage de mâchoire de frein / Set voor montage van remkaken



Ref.	📦	EAN
11-131	1/5	5907558437270

Zestaw do sprawdzania bicia tarcz hamulcowych

Brake disc run out kit / Prüfsatz für Unrundlauf von Brems Scheiben / Набор для проверки тормозных дисков / Набор для перевірки гальмівних дисків / Társcsafék ütőmérték készlet / Trusă pentru verificarea bății discurilor de frână / Sada pro kontrolu brzdových kotoučů / Súprava na kontrolu brzdových kotúčov / Komplet za preverjanje zavornih diskov / Rinkinys stabžičiu diskų patikrinimui / Bremžu disku pārbaudes instrumentu komplekts / Piduriketaste kontrollimise komplekt / Комплект за проверка на биемето на спрочачиме дискове / Set za proverju kočionih pločica / Pribor za proverju kočionih diskova / Σετ ελέγχου διακυμάντων / Kit para la comprobación de los discos de freno / Kit per il controllo dell'oscillazione assiale dei dischi freno / Kit de verificação de batimento dos discos de travão / Kit de mesure pour disques de freins / Remschijf opraken kit



±0.01 mm

Ref.	📦	EAN
11-130	1/10	5907558437263

Przyrząd do modelowania końcówek rur

Tabbing cutter and flaring tool set / Gerät zum Modellieren von Rohrenden / Труборез и развальцовщик, набор / Комплект інструменту до порізки та розвальцовки труб / Csővágó, peremező készlet / Dispozitiv pentru modelarea pieselor de îmbinarea țevilor / Zařízení na tvarování nástavců trubek / Sada nástrojov na modelovanie nástavcov rúr / Orodje za rezanje in rabljenje cevi / Varnadžiū angaliū užspaudimo ir praplėtimo rankių rinkinys / Caurulgręžtu un caurulu izvelmētāju komplekts / Komplekt torude liīkamiseks ja valtsimiseks / Комплект інструменту за різання і моделювання кінцівката на трьбу / Alat za narezavanje i modeliranje cijevi / Pribor za modelovanje krajeva cevi / Κάπτης σωλήνων και εργαλείο για διέκταση σωλήνων, σετ / Herramienta para amoldar las puntas de tubos / Utensile per modellare il fine tubo / Aparelho p. formar ponteiros de tubos / Outil de modelage d'embouts de tubes / Knijpgereedschap voor eindstukken

w zestawie obcinak do rur średniocyńch i aluminiowych cutter for Cu and Al pipes dla tręby Cu i Al



25 years WARRANTY

x10 AL Cu

Ref.	Ra[mm"]	📦	EAN
02-050	4, 4.75, 6, 8, 10, 12, 14 mm	0/12	5907558410020

Ściągacz do piast

Wheel hub puller / Abzieher für Radnaben / Съёмное приспособление для ступиц / Знімач маточин / Kerékagy lehúzó készlet / Ancoră de butuc / Stahovák hlavy kola / Stahovák náboja / Izvlekač za pesta / Stebulių spausčiai / Rumbų poještama įerše / Rattarummi tömmiss / Скоба за втулку / Skidač za glavčine / Stega za glavčinu / Εξολκείας πλινθής / Extractor de cubos de ruedas / Estrattore a bilanciere / Ponta de apertor / Extracteur de moyeux / Trekker voor naaf



Ref.	⚙	EAN
11-811	5/20	5907558418484

Ściągacz do kota kierownicy

Steering wheel puller / Abzieher für Lenkungsrad / Съёмное устройство рулевого колеса / Знімач керма / Kormánykerék leszedő készlet / Ancoră de volan / Stahovák volantu / Stahovák volantu / Izvlekač za volan / Vairo traucēš nuemklis / Stüres rata poještama įerše / Juhtratta tömmiss / Скоба за колелото на волана / Skidač kotača volana / Stega za upravljač / Εξολκείας τιμονιού / Extractor de volante / Estrattore di volante / Ponta de apertor para volante / Extracteur de volant / Trekker voor stuurwiel



Ref.	⚙	EAN
11-816	5/20	5907558416966

Zestaw tomów

Go-through pry bar set / Brechstangen-set / Набор монтажек / Набор помп / Feszítővas készlet / Set de răngi de oțel / Sada pačidel / Súpřava pačidel / Komplet lomítk / Laužtūvy rinkinys / Laužtūvo komplekts / Kangide komplekt / Комплект щангов / Set poluga / Garnitura poluga / Set koutalēs / Juego de palancas / Set di leve da sforzo / Kit de pés-de-cabra / Jeu de pieds-de-biche / Set van breekljzers



Ref.	L[mm]	⚙	EAN
11-113	200, 300, 450, 600	0/10	5907558416633

Łyżka do opon

Wrecking bar / Reifenlöffel / Монтажна автомобильная / Монтуваална / Gumiabroncs szerelős / Levier pentru pneu / Montážní páka na pneumatiky / Páka na pneumatiky / Žlica za pnevmatiku / Svirts padangy montavimui / Lāpšņa riepu montāžai / Rehvilusikas / Щона за демонтаж на гуми / Podizač za montiranje guma / Kašika za gumu / Κουτάλα φαναλαός / Llave cuchara para extraer ruedas / Leve per pneumatici / Ferramenta para rodas / Demonte-pneus / Breekljzer



Ref.	L[mm]	⚙	EAN
11-111	400	10/20	5907558416619
11-112	500	10/20	5907558416626

Ściągacze do sprężyn

Spring pullers / Abzieher für Feder / Съёмные приспособления для пружин / Знімачі пружин / Rugóösszenyomó / Ancore de arcuri / Stahovák pružin / Stahovák pružin / Izvlekač za vzmeti / Spyrkuokliū spausčiai / Atsperu poještama įerše / Vedruštömmitsad / Скоба за пружину / Skidač za opruge / Stega za oprugu / Εξολκείας ελατηρίων / Extractor de muelles / Pressori per molle / Ponta de apertor para molas / Extracteurs de ressorts / Trekkers voor veren

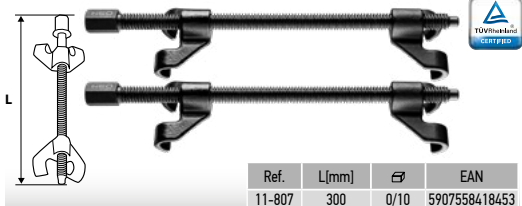

Ref.	L[mm]	⚙	EAN
11-807	300	0/10	5907558418453



Ref.	L[mm]	⚙	EAN
11-808	300	0/10	5907558418460



Ref.	Ra[mm]	⚙	EAN
11-796	23-280	1/5	5907558436747



125/212 mm, 8/160 mm, 65/125 mm.

BMW: E31 - E67, MINI R50/R52/R53, Fiat, Alfa Romeo, Chrysler, Lancia, Ford, Mazda, Honda, Hyundai, Jaguar, Jeep, Kia, Mercedes C/E, Citroen, Peugeot, Opel, Vauxhall, Saab, Renault, Nissan, Infiniti, Dacia, Mitsubishi, Rover, Subaru, Toyota, Audi, Porsche, Skoda, VW, Volvo

Ref.	⚙	EAN
11-797	1/1	5907558436754

Ściągacze do sprężyn

Spring pullers / Abzieher für Feder / Съёмные приспособления для пружин / Знімачі пружин / Rugdösszehűző kézi / Ancore de arcuiri / Stahováky pružin / Slahováky pružin / Izvlekači za vzmeti / Spruokliki spruovaiti / Atsperu nopetama ierice / Vedrutõmmisad / Скобы за пружину / Skidači za opruge / Stega za oprugu / Εξολκός ελατηρίων / Extractor de muelles / Pressori per molle / Ponta de aperto para molas / Extracteurs de ressorts / Trekkers voor veren



70-130
90-150
mm



70/130 mm, 90/150 mm
Mercedes

W123, W124, W126, W140, W202, W210

W107, W114, W115, W116, W123, W124, W126, W129, W140, W201, W202, W203

Opel / Vauxhall / Hyundai / Lada / Rover / Saab / Fiat / Ford / Mazda / Toyota / Nissan / Mitsubishi / Peugeot / Volvo / VW

Ref.	Ra[mm]	⊗	EAN
11-798	70-130; 90-150	1/2	5907558436761

Zestaw ściągaczy do drążków kierowniczych

Steering rods puller set / Abziehvorrichtungssatz für Spurstangen / Набор съёмников шаровых опор и рулевых наконечников / Набор знімачів до кермових тяг / Korrtányószekelő-gömbfejkinnyelő készlet / Set trăgătoare bare de comandă / Sada stahováků táhel řízení / Sada stahovákov tiahiel riadenia / Set izvlekačev za krmilne drageve / Guolinji atramji ir vairo traukiu nuėmimo rinkinys / Stūres uzgluņ un sfērisko balstu novilcēju komplekts / Roalivarda tõmmisate komplekt / Комплект скобы за извращение на нормальных шанге / Set skidači za uprovaljačke šipke / Pribor alatki za skidanje upravljačkog stalka / Set εξολκίων αρθρωτικών αρθρώσεων και κατευθυντήριων ραβδών / Juego de extractores de barras de dirección / Kit di estrattori per tiranti dello sterzo / Kit de extractores de barras de direção / Kit d'extracteurs de biellette de direction / Trekkers voor stuurstangen



Ref.	⊗	EAN
11-799	1/2	5907558436778

Uniwersalny ściągacz do przegubów

Tie rod end lifter / Universelle gelenkabhieher / Универсальный съёмник шаровых шарнирных соединений / Знімач шарнірів універсальний / Gömbcsukló kinnyelő / Extractor universal pentru articulatii / Univerzální stahováč kloubů / Univerzálny stahováč čapov / Univerzalni snemalac zglobov / Universalus šarnyru nuėmėjas / Universālais šarnīru novilcējs / Universalsed klambritõmmisad / Универсална скоба за шарниру / Univerzálni skidači za zglobove / Univerzalna stega za zglobove od / Εξολκός αρθρωτικών αρθρώσεων γενικής χρήσης / Extractor universal de juntas / Estrattore universale per giunti / Sador universal de articulações / Extracteur de rotule universel / Universele trekker voor verbindingstukken



Ref.	ø [mm]	⊗	EAN
11-801	20	0/20	5907558416527

Dźwignia do przegubów

Lever for articulated joints / Hebel für Gelenke / Рычаг для шарниров / Вахлінь до шарнірів / Gömbfejserelő villa / Levier de articulation / Podpěra kloubů / Páka k čapov / Vilice za zglobe / Vyruči svirts / Šarnīru svira / Klambrikang / Лост за шарниру / Poluga za zglobove / Poluga za zglobove / Μοχλός μετεξόδων / Palanca para rótulas / Leva per giunti articolati / Alavanca p. Articulações / Levier pour articulations / Heefboom voor spilverbindingen

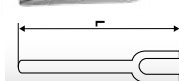

Ref.	L [mm]	⊗	EAN
11-805	300	0/12	5907558418590
11-806	400	0/12	5907558418606

Ściągacz do przegubów

Ball joint puller / Gelenkabhiehvorrichtung / Съёмник шарниров / Пристрій для зняття шарнірів / Gömbcsukló kinnyelő / Extractor articulatii sferice / Stahováč kloubů / Stahováč na gulavé čapy / Snemalac / Nuėmėklis šarnyrams / Novilcējs / Kuullidesõmmits / Скоба за болтаев / Izvlekač / Radapciger / Κροκονάλυκο για καστανίς / Extractor de juntas de rótula / Estrattore di giunti a sfera / Ponta de aperto de articulações / Arrache-articulations / Trekker voor spilverbindingen

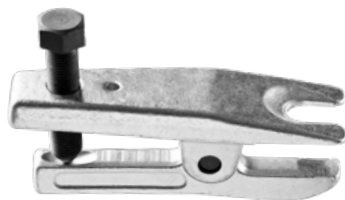

Ref.	ø [mm]	⊗	EAN
11-802	19	0/20	5907558418422

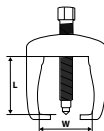

Ref.	L [mm]	W [mm]	⊗	EAN
11-803	45	27	0/20	5907558418439
11-804	65	32	0/20	5907558418446

Pneumatische urządzenie do montażu oston przegubów

Pneumatic cv joint install tool / Pneumatische Vorrichtung zur Montage von Gelenkabdackungen / Πνευματικός расширитель пыльников для их замены без разбора / Πνευματικός rozširšovac pylníkyho dia ich zameny bez rozobrania / Pneumatikus féltengely gumiharang felszerelő / Dispozitiv pneumatic pentru montajul protecției articulațiilor / Pneumatický prípravok na montáž manžet kloubů / Pneumatické zariadenie na montáž klbových krytov / Pneumatisko orodje za montažo manšet zglobov / Pustašio šarnyru purvasargio uždejimo pneumaticis įrankis / Puteklšargu pneimatiskais paplašinātājs to nomaini bez demontāžas / Liigendikate paigaldamise pneumesoodmed / Пневматично устройство за монтаж на защитите на шарните / Pneumatski uređaj za montažu štitnika zglobova / Pneumatski uređaj za montažu zglobnih zaštita / Πνευματικό εργαλείο τοποθέτησης φουσσών ηλιοζώνιου / Dispositivo neumático para el montaje de tapas de juntas / Dispositivo pneumatico per l'installazione di protezioni dei giunti / Aparelho pneumático para montar juntas de eixos / Expandeur pneumatique de soufflets de cardan / Pneumatisch toestel voor montage van afscherming van koppelingen



Ref.	⚙️	EAN
11-795	1/4	5907558436730

Ściągacz z sitownikiem

Hydraulic puler / Abzieher mit Servoantrieb / Съёмник с гидрприводом / Знімач із гідрприводом / Leházó hidraulikus rásegítéssel / Extractor cu dispozitiv de actionare / Hydraulický stahovák / Stahovák so servomotorom / Hidravlični izvlečak / Hidraulinis nutraukiklis / Novičejš ar hidropedziru / Servomotoriga tšimmits / Инструмент за демонтаж с цилиндър / Skidáč sa cilindrom / Alatka za skidanje sa hidraulikom / Υδραυλικός εξολκέας / Extractor con accionador / Estrattore con cilindro / Extrator con accionador / Extracteur avec vérin / Hydraulische trekker

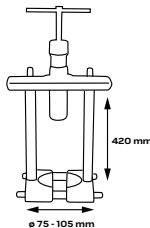

Ref.	⚙️	EAN
11-847	1/2	5907558436853

Ściągacz do ramion wycieraczek

Wiper arm puller / Abzieher für Scheibenwischer / Съёмник рычагов стеклоочистителя / Знімач важеля склоочисника / Ablaktöröl kar leházó / Dispozitiv de scos de brate de stergător de parbriz / Stahovák na ramínka stieračů / Stahovák na demontáž ramienok stieračov / Snemalec za brisalce / Valjutny kotų nuėmiklis / Stikla tirtāju plecu novičejš / Kojamehe hoobade tšimmits / Сноба за ramo на чистачката / Alat za skidanje brizgajki / Alat za skidanje ramena brisača / Εξολκέας μοχλών υλοκαθαριστήρα / Extractor de brazos de limpiaparabrisas / estrattore per braccio del tergicristallo / Extrator de limpa para-brisas / Extracteur de bras d'essuie-glaces / Trekker voor ruitenwisserarmen



Ref.	⚙️	EAN
11-827	0/120	5907558420067

Ściągacz dwuramienny i separator

Gear puller set / Abzieher mit zwei schenkeln und ausscheider / Съёмник универсальный с сепаратором / Знімач двооплечевый і сепаратор / Csapágyeleházó készlet / Extractor universal cu două brațe și separator / Sada dvouramenný stahovák a oddělovač / Súprava dvouramenný stahovák a separátor / Komplet dvokrakega snemalca in ločilnika / Dvišakių nuėmėjų rinkinys su separatorium / Divplecu novičejš un separatora komplekts / Kaheharuline tšimmits ja separator / Комплект двурамenna стьаза със сепаратор / Set dvokraki skidáč i separator / Garnitura dvokraka stega i separator / Εξολκέας γενικής χρήσης με διαχωριστή / Juego de extractores de dos brazos y separador / Set separador per cambio / Kit sacador de 2 garras e separador / Jeu d'extracteurs a 2 bras et separateur / Tweearmig trekker en separator



Zestaw do separacji elementów połączonych wzdłuż osi jak łożyska, kola zamachowe, rolki itp. Zakres separatora: max 43 mm, Zakres ściągacza: 35 – 75 mm

The set is used for separating axially connected elements, such as bearings, flywheels, rolls, etc. Separator range: max. 43 mm, Puller range: 35 – 75 mm, Plastic case

Набор для снятия соосно установленных элементов, таких как подшипники, маховики и т.п.

Диапазон сепаратора: max 43 мм, Диапазон съёмника: 35 – 75 мм, Пластмассовый кейс

Ref.	⚙️	EAN
11-810	0/4	5907558416572

Ściągacz dwuramienny

2 jaws puller / Abzieher mit zwei schenkeln / Съёмник подшипников 2-х лопаточный / Знімач двооплечевый / Csapágyeleházó, kétkörmös / Extractor cu două brațe / Stahovák dvooramenný / Dvouramenný stahovák / Dvokraki snemalec / Nuėmėjas, dvišakis / Divplecu novičejš / Kaheharuline tšimmits / Двурамenna сноба / Dvostruki odvajáč / Dvokraka stega / Εξολκέας έναρπιων τριών με 2 αγωγές / Extractor de dos brazos / Estrattore a due griffe / Sacador de 2 garras / Extracteur a 2 bras / Tweearmig trekker



Ref.	L [mm]	⚙️	EAN
11-850	75	0/50	5907558416817
11-851	100	0/50	5907558416824
11-852	150	0/50	5907558416831

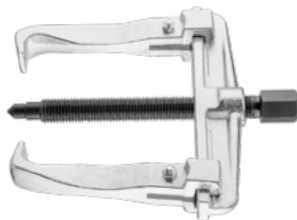

Ref.	L [mm]	⚙️	EAN
11-865	100	0/16	5907558418514
11-866	110	0/12	5907558418521
11-867	140	0/12	5907558418538

Mini ściągacz dwuramienny

Mini two-arm puller / 2-Arm Mini-Abzieher / Съемник с двумя захватами "мини" / Мини-знімач двооплечевий / Csapágyelhúzó, kétkörmös, mini / Mini extractor cu doua brațe / Dvooramenný mini stahovač / Mini stahovač dvojrarmenný / Dvokraki snemalec / Dvižajnis mini nutraukiklis / Dviplecu mini-novilcējs / Kahearmuline mini lõmmits / Двураменна мини скоба / Dvokraki mini izvlačač / Dvokraki mini alat za skidanje / Μικρός εφελκός με δυο σιαγόνες / Mini extractor de dos braços / Mini estrattore a due griffe / Mini extractor de dois braços / Arrache mini à deux branches / Mini tweearmige trekker



Ref.	L [mm]	Φ	EAN
11-871	25	25/100	5907558420159
11-872	50	25/100	5907558420166
11-873	75	25/50	5907558420173

Ściągacz trójramienny

Three-arm puller / 3-Arm Abzieher / Съемник с тремя захватами / Знімач триоплечевий / Csapágyelhúzó, háromkörmös / Extractor cu trei brațe / Тріраменнй стahovač / Trojramenný stahovač / Trokraki snemalec / Trizajnis nutraukiklis / Trisplecu novilcējs / Kolmearmuline lõmmits / Тримаренна скоба / Trokraki izvlačač / Trokraki alat za skidanje / Εφελκός με τρεις σιαγόνες / Extractor de tres brazos / Estrattore a tre griffe / Extrator de três braços / Arrache à trois branches / Driearmige trekker



Ref.	L [mm]	Φ	EAN
11-868	25	0/50	5907558420128
11-869	50	0/50	5907558420135
11-870	75	0/50	5907558420142



Ref.	L [mm]	Φ	EAN
11-857	150	0/16	5907558416862
11-858	200	0/6	5907558416879
11-859	300	0/2	5907558416886



Ref.	L [mm]	Φ	EAN
11-861	100	0/20	5907558416794
11-862	150	0/10	5907558416800

Ściągacz do łożysk

Gear puller / Lagerabziehvorrichtung / Съемник подшипников / Пристрій для зняття підшипників / Csapágyelhúzó / Extractor elicooidal / Stahováč ložisek / Stahováč dvojrarmenný / Snemalec / Guolių nuėmiklis / Novilcējs gultņiem / Hammarratta lõmmits / Скоба за лагеру / Izvlačač / Radaprciger / Κροκονάλυγο για αξόνες τριβής / Extractor de cajinetes / Estrattore rapporti / Ponta de aperto para rolamentos / Arrache-roulements / Lageronderbank

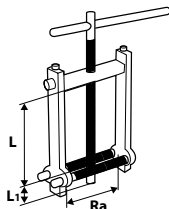

Ref.	L [mm]	L ₁ [mm]	Ra [mm]	Φ	EAN
11-813	100	20	24 - 55	0/30	5907558418507



Ref.	Ra [mm]	Φ	EAN
11-848	35-130	1/2	5907558436860

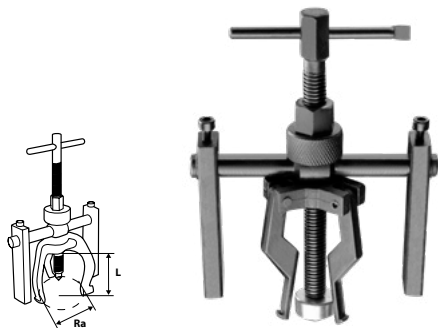

Ref.	L [mm]	Ra [mm]	Φ	EAN
11-812	70	32 - 64	0/20	5907558418491

Indukcyjna grzałka do śrub

Induction bolt and screw heater / Induktives Heizgerät für Schrauben / Индукционный нагреватель / Нагревач индукційний / Indukciós hevítő készlet / Incalzitor cu inducție pentru șuruburi / Indukční ohřev šroubů / Indukčný ohrievač pre skrutky / Indukcijski grelnik za vijake / Indukcinis šildytuvus varžtams / Indukcijas sildītājs / Induktisioon-põldisoojendi / Индукционен нагревател за болтове / Indukcijski grijač za vijke / Indukcionni grejač za šrafove / Επαγωγικός θερμαντήρας / Calentador de inducción para tornillos / Riscaldatore ad induzione per viti / Aquecedor de indução para parafusos / Pistolet à chaleur inductive pour vis / Inductie dampelaar voor schroeven

700°C 1200W



Ref.	☞	EAN
11-931	0/1	5907558436969

Przecinaki do nakrętek

Nut splitters / Meißel für Mutter / Γαϊκόκοπες / Розривач до мутр / Csavaranyagók / Dőlőjű prutle / Trháč matic / Trhače matic / Lomilici matic / Verziő kirstukai / Uzgriežņu cirņi / Meisliid / Сечачи за гайки / Rezač za matice / Sekač navrtanja / Κάψες παζμιαίων / Tajadera de tuercas / Spaccadadi / Cortadores de porcas / Burris à écrous / Moerknippers



osko 9 - 12 mm / klucz 12 mm
9 - 12 mm nut splitter. Spaner drive shaft 12 mm
размер гайки 9 - 12 мм / ключ 12 мм
osko 12 - 16 mm / klucz 14 mm
12 - 16 mm nut splitter. Spaner drive shaft 14 mm
размер гайки 12 - 16 мм / ключ 14 мм
osko 16 - 22 mm / klucz 19 mm
16 - 22 mm nut splitter. Spaner drive shaft 19 mm
размер гайки 16 - 22 мм / ключ 19 мм
osko 22 - 27 mm / klucz 21 mm
22 - 27 mm nut splitter. Spaner drive shaft 21 mm
размер гайки 22 - 27 мм / ключ 21 мм

Ref.	☞	EAN
11-925	0/10	5907558436945

Zestaw nasadek

Socket set / Aufsatzset / Набор головок торцевых / Набор насадок торцевых / Törtsavarkijahő készlet / Set duze / Sada násadek / Súprava nástr. klúčov / Garnitura nasadnih ključev / Antalgij rinkinsky / Muciji komplekt / Padrunkomplekt / Гедоре комп / Šesterokutne kapice / Gedora set / Συλλογή καρδιακίων / Llaves de vaso / Set di boccole / Kit de bicos / Jeu de douilles / Set van doppen

8, 10, 11, 12, 13, 14, 15, 16, 17, 19, 21, 22, 24, 27 mm

2 wybijaki do usuwania śrub z nasadek
2 x punches

2 выколотки для снятия винтов с головок

Można stosować z kluczami udarowymi
Suitable for impact wrenches

Можно использовать с ударными гайковертами

Wewnętrzna spirala powoduje samoczynne zaciskanie się na uszkodzonej śrubie/nakrętkę umożliwiając bezpieczne odkręcenie
The innovative spiral profile digs itself into the head of a damaged screw/nut and thereby allows to loosen it securely
Внутренняя спираль вызывает автоматическое зажатие поврежденного болта/гайки, обеспечивая безопасное откручивание

x16 1/2"

9, 10, 11, 12, 13, 14, 15, 16, 17, 19 mm

przetyczka 1 szt.

1 x punches

1 x удель

x11 3/8"

Wewnętrzna spirala powoduje samoczynne zaciskanie się na uszkodzonej śrubie/nakrętkę umożliwiając bezpieczne odkręcenie
The innovative spiral profile digs itself into the head of a damaged screw/nut and thereby allows to loosen it securely
Внутренняя спираль вызывает автоматическое зажатие поврежденного болта/гайки, обеспечивая безопасное откручивание



Ref.	☞	EAN
11-920	0/10	5907558436914



Ref.	☞	EAN
11-922	0/20	5907558436938

Wykrętaki do śrub

Screw extractor set / Schraubendreher / Экстракторы для винтов / Викручувачі зламаних гвинтів / Törtszavar-kihajtó készlet / Set înlăturare șuruburi / Vyťahováč šroubů / Súprava vyťahovačů zalamených škrutiek / Garnitura odvijajućev vijakov / Atsuktuvai varžtams / Skrūvių izvilcijs / Kruiveemaldukskomplekt / Izvijac polomljenih vijaka / Συλλογή μηχανημάτων αφαιρέσης βιδών / Extractores de tornillos / Estrattori di viti / Saca-parafusos / Deviseuses pour vis / Schroevelosdraaiers

- 6 wykrętałów 3/8"
- długość 60 mm
- 2 mm do śrub M5
- 3 mm do śrub M6
- 4 mm do śrub M8
- 6 mm do śrub M10-12
- 8 mm do śrub M14-16
- 10 mm do śrub M18-20



- 6 screw extractors 3/8"
- length 60 mm
- 2 mm for M5 screws
- 3 mm for M6 screws
- 4 mm for M8 screws
- 6 mm for M10-12 screws
- 8 mm for M14-16 screws
- 10 mm for M18-20 screws

- 6 высверливателей 3/8"
- длина 60 мм
- 2 мм для винтов M5
- 3 мм для винтов M6
- 4 мм для винтов M8
- 6 мм для винтов M10-12
- 8 мм для винтов M14-16
- 10 мм для винтов M18-20

Ref.	Ra[mm]	L[mm]	⌀	EAN
09-605	2-10	60	0/50	5907558410341



Ref.	Ra[mm]	Ra[*]	⌀	EAN
09-607	3 - 14	1/8 - 1/2	0/20	5907558417241



Ref.	Ra[mm]	⌀	EAN
09-615	1/8" (M3-M6), 1/4" (M6-M8), 5/16" (M8-M11), 7/16" (M11-M14), 9/16" (M14-M18)	25/150	5907558416497



Ref.	Ra[mm]	⌀	EAN
09-609	2, 3, 4, 6.5, 7.5	0/60	5907558416503



Zestaw do naprawy gwintów

Thread repairing kit / Gewindegereparatursatz / Набор для восстановления резьбы / Набор для відновлення гвинтованих з'єднань / Menetjavító készlet / Set de rectificat fileturi / Sada pro opravu závítů / Súprava na opravu závítov / Set za popravilo navojev / Srigiemo įrankių rinkinys / Skrūvių remontkomplektis / Keertgeraanduskomplekt / Комплект за ремонт на резу / Set za popravak navoja / Pribor za popravku šrafova / Set αποκατάστασης απειρωμάτων μ5 / Juego de reparación de tornillos / Kit riparazione filetti / Jogo de ferramentas para reparacão de roscas / Kit de réparation de taraudages / Schroefdraad herstelset



Ref.	⌀	⌀	EAN
11-901	M6	10/40	5907558419870
11-902	M8	10/40	5907558419887
11-903	M10	10/40	5907558419894
11-904	M12	10/40	5907558419900



Wkłady do naprawy gwintów

Thread repairing kit / Gewindegereparatureinsätze / Набор резьбовых вставок / Набор для відновлення гвинтованих з'єднань / Menetjavító betét / Adasuri de rectificat fileturi / Vložky pro opravu závítů / Vložky na opravu závítov / Set za popravilo navojev / Srigiemo galvučių rinkinys / Leliktipi vītņu remontam / Keertgeraandustüübld / Ενεμητι για ремонт на резу / Umetci za popravak navoja / Umetak za popravku / Set ένθετα απειρωμάτων / Repuestos para reparacón de tornillos / Kit riparazione filetti / Cartuchos para reparacão de roscas / Inserts de réparation de taraudages / Inzeldelen voor schroefdraad herstel



Ref.	⌀	N	⌀	EAN
11-905	M5	20	50/250	5907558419917
11-906	M6	20	50/250	5907558419924
11-907	M8	20	50/250	5907558419931
11-908	M10	20	50/250	5907558419948
11-909	M12	10	50/250	5907558419955

Narzynki i gwintowniki

Tap and die set / Schneideisen und Gewindebohrer / Плашки и метчики / Поэначники и плашки, набор / Menetkészítő készlet / Set scule tăiere filet interior și exterior / Závítnice a závitníky / Súprava závitníkov / Garnitura vrezníkov in nareznikov navoja / Sriegapjovės ir sriegikliai / Vitngrežu komplekts / Kraaija valuvorni komplekt / Метчици и плашки / Nareznice i ureznice set / Set ureznika i nareznika / Ελικοκάρτες και κολλοῦχα / Cojinetes y machos de roscar, juego / Madreviti e maschi / Cassonetes e roscas / Filières et tarauds / Snijplaat en schroefdraad snijtoestel



x110

Ref.	⌀	EAN
11-915	1/3	5907558436907

Wkręтак ударowy

Impact screwdriver / Schlag-Schraubendreher / Отвёртка ударная / Викрутка ударна / Ütvecsavarozó készlet / Surubelnjiti cu percutor / Sroubovák rázový / Rázový skrutkovač / Udarni izvijač / Smūginis suktavas / Trieciena skrūvgrēzis / Löökkruvikeeraja / Ударна отвёртка / Odvijač s udarom / Udarni odvijajač / Καταβίβη κρούσης / Destornillador de impacto / Cacciavite a percussione / Chave de fenda de impacto / Tournevis à chocs / Slagschroevendraaier



⌀ 5, 6, 8, 10, 12, 14 mm

⊕ PH1, PH2, PH3



Ref.	m[kg]	⌀	EAN
04-250	1,2	0/12	5907558410082

Smarownica dźwigniowa

Lever-operated grease gun / Schmierspritze mit Hebel / Шприц рычажно-пнунжерный / Шприц важільно-пнунжерный / Karos zsízró / Gresor cu prghie / Páková maznice / Páková mazica / Ročna mazalica / Rankinis tepalo presas / Leeļotājs ar sviru / Kangiga maärimiseseade / Ръчна масленка / Mazalica ručna / Mazalica na pumpu / Γρασοδότης με ροαλή / Engrasadora de palanca / Pistola per grasso / Pistola de lubrificação / Graisseur à levier



400 cm³

10000 Psi

8x300 mm

Ref.	⌀	EAN
11-500	0/10	5907558415278

Wężyk do smarownic

Hose for grease gun / Schlauch für Schmiergeräte / Шланг смазочный / Шланг до дозатора оливи / Zsízró cső / Furtunpentru pistol de gresare/ungere / Hadička pro mazničky / Hadička do maznic / Čev za mazalnike / Žarnele tepalnéms / Caurulite elias kanniri / Ölüpüstoilvoolik / Маркуа за масълёнка / Crijevo za mazalice / Crevo za podmazivanje / Ελαστικός σωλήνας λιπανσης / Manguera para engrasadoras / Tubo in Nylon / Mangueira para lubrificadores / Flexible de graisseur / Slang voor smeergapparaaten



do smarownicy 11-500 for 11-500 grease gun для масленки 11-500

Ref.	L [mm]	⌀	EAN
11-530	8x220	0/250	5907558415285
11-532	11x300	0/100	5907558415308

Olejarka z końcówką sztywną

oiler with rigid spout / Öler mit steifer Endung / Масленка с твёрдой / Опивница зі штивним наконечником / Olajozó merev / Ungator cu piesa de imbinare rigida / Maznička s pevnou koncepcovkou / Olejnička s pevným nástavcom / Kanta za ulje s togim nastavkom / Tepalnice su kietu antigaliu / Ελιόταjs ar cieto uzgali / Jäiga otsakuga õlikann / Масълёнка с твърд накрайник / Kantica za ulje s krutom crijevom / kantica za ulje sa krutom kuprom / Λιπαντήρας με στήαο / Aceiteira con punta rigida / Pompeta per olio / Azeiteira para lubrificação com ponta rigida / Huileuse de avec embout rigide



350 cm³

250 mm

Ref.	L[mm]	⌀	EAN
11-512	250	10/100	5907558415377

Nasadka do świece

Spark plug socket / Aufsatz für Zündkerzen / Головка сменная свечная / Ключ свичный / Gyertyakulcs / Cheie tubulara pentru bujii / Nástavec na svičky / Nástavec na svičky / Nasadni ključ za svečke / Galvutė žvakėms / Sveči atslėga / Kiünlapadrun / Наставка за свеци / Kapica za svječice / Nasadka za svečice / Καρβόκι για πουαή / Vaso para bujia / Chiave per candele / Bocal p. velas / Douille à bougie / Kaarsendop

x11

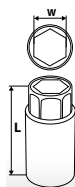

Ref.	W [mm]	L[mm]	⌀	EAN
08-090	16	65	24/144	5907558406092
08-091	21	68	24/96	5907558406252

Klucz do świece

Spark plug wrench / Zündkerzenschlüssel / Ключ свечной / Ключ для свічок / Gyújtógyertyakulcs / Cheie luminaře / Klüč na svíčky / Ključ svečkovj / Ključ za vžigalno svečka / Raktas degimo žvakėms / Svečatslēga / Süiteküünti vāti / Ключ / Ключ / Ключ / Ключи για μπουζι / Llave para bujía / Bussolo poligonali / Chave p. velas / Clef à bougie / Kaarsleutel



25 years
guarantee

TÖRNMÉRLEG
ESZTÉBÉL

3/8"



Ref.	W [mm]	L [mm]	Ø	EAN
11-152	14	90	50/100	5907558417166
11-153	16	90	50/100	5907558417173

Szczypce do ściągania przewodów zapłonowych

Spark plug wire boot pliers / Zange zum Abziehen von Zündkabeln / Пассокубы для снятия проводов зажигания / Пассокубы для зняття дротів запалювання / Gyújtókábel lehozó fogó / Clește pentru scoaterea cablurilor de aprindere / Kleště na kabely zapalovacích svíček / Klešte na demontáž zapalovacích vodičov / Kleště za vtiče vžigalnih svečk / Repljil rinkinyš. užvedimo laidų nužiūvinimui / Platknables aizdedzes vadu nopemšanai / Süitejuhtmete näpitsad / Клеци за набулну на свещице / Klješta za skidanje žica za paljenja / Klješta za skidanje kablova svećica / Πένα εργαλείου μπουζοκαλωδίων / Alicates para quitar los cables de arranque / Pinze per lo scollamento dei cavi d'accensione / Alicates para extração de cabos de ignição / Pincez pour enlever les câbles batterie / Tangen voor bougie leidingen

25 years
guarantee



Ref.	Ø	EAN
11-165	5/20	5907558437294

Zestaw do demontażu poduszek powietrznych

Airbag removal tool set / Abbausatz für Luftkissen / Набор для замены подушки безопасности / Набор для заміни подушок безпеки / Légzsák kiszerező készlet / Set pentru scoaterea airbag-urilor / Sada na demontáž airbagů / Súprava na demontáž airbagov / Set za odstranitev zračnih blazin / Oro pagalvių išmontavimo rinkinys / Drošības spilvena noņemšanas instrumentu komplekts / Öhkratjade eemaldamise komplekt / Комплект за демонтаж на въздушни възглавници / Set za skidanje zračnih jastuka / Pribor za demontiranje vazdušnih jastuka / Set de ferramentas de desmontagem de airbags / Kit de démontage des airbags / Set voor demontage van airbags

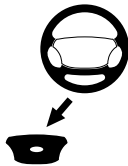

Ref.	Ø	EAN
11-817	1/10	5907558436785

Zestaw do demontażu szyb

Car windows disassembling set / Abbausatz für Scheiben / Набор для демонтажа лобовых стекол / Набор для демонтажу вітрового скла / Szélvédő kiszerező készlet / Set pentru demontarea geamurilor / Souprava pro demontáž skel / Súprava na demontáž okien / Set za odstranitev stekel / Automobiliinių stiklų išmontavimo rinkinys / Autostiklu demontāžas komplekts / Tuuleklaasi eemaldamise komplekt / Комплект за демонтаж на остъкна / Set za demontažu stakla / Pribor za demontiranje stakla / Set εργαλείου παμπζικ / Kit de desmontaje de ventanillas / Kit per lo smontaggio di cristalli / Kit de ferramentas de desmontagem de vidros / Kit de démontage de vitres



Ref.	Ø	EAN
11-819	1/10	5907558436792

Komplet narzędzi hakowych

Hooks / Hacken / Крюк / Гаук / Karpós készle / Cártilge / Háky / Skoby / Kljuje / Kabliai / Āķi / Haogid / Hуку / Крюк / Крюк / Ганчос / Ganchos / Ganci / Anzóis / Crochets / Haken

25 years
guarantee

TÖRNMÉRLEG
ESZTÉBÉL

CrV
steel

x4



Ref.	Ø	EAN
04-230	6/48	5907558410075

Szczypce do klipsów

Trim clip removal pliers / Trimmzange zum Entfernen des Clips / Пассокубы для удаления клипсы / Пассокубы для удалення клипсы / Vágókarpos-eltávolító fogó / Clești pentru scoaterea clemelor / Kleště na odstranění klipů / Klešte na odstraňovanie spŕn / Klešte za odstranjevanje sponk / Savaržų šalinimo replės / Klipu nopemšanas knaibles / Klambrite eemaldamise tangid / Клеци за премахване на клип / Klješta za uklanjanje isječka / Клешта за уклањање клипа / Πένα αφαιρέσης κλιπ / Recorte alicates de extracción de clip / Pinzo per tagliare clip / Alicates de remoção de cliques de acabamento / Pince pour enlever les clips / Tang voor verwijderen van clip

25 years
guarantee

35x35
mm



Ref.	Ø	EAN
11-030	6/36	5907558445527

NEO
TOOLS

NARZĘDZIA WARSZTATOWE

WORKSHOP TOOLS

ИНСТРУМЕНТЫ МАСТЕРСКОЙ

Zestaw ściągaczy do tapicerki

Upholstery puller set / Lösehebel-Satz für Polster / Набор съёмников панелей облицовки / Набор знімачів до обшивки салону / Kárpítleszedő készlet / Set de scos piese de tapiterie / Sada pro demontáž čalounění / Súprava na demontáž čalúnenia / Set smetalcev oblažinjena / Tvirtinimo elementu istraukiklicy / Tapsėjuma novicėju / Polstritõmmitsate / Комплект скобы на тапцперу / Set za skidanje tapicerung / Pribor alata za skidanje tapetarskog materijala / Σετ εξολκεις πλακών επένδυσης / Juego de extractores de tapizado / Serie di utensili per interni / Conjunto de extractores para tapiceria / Jeu d'extracteurs de tapisserie / Set van trekkers voor stoffering



Ref.	☞	EAN
11-825	6/12	5907558436808



Ref.	N	☞	EAN
11-822	5	6/24	5907558420029
11-823	6	6/24	5907558420036
11-824	11	0/10	5907558420043

25 years
WARRANTY

NYLON

Zestaw spinek samochodowych

Car pins / Auto-Körper-Clipsset / Клипсы крепления обшивки / Набор кліпс кріплення обшивки / Gépkocsi rögzítő patent készlet / Set de clipuri auto / Sada přichytek čalounění / Súprava sponiek do auta / Set avtomobilskih sponk / Avtomobilnių tvirtinimo elementų rinkinys / Arşuvuma stiprinājumi komplekts / Autotivthide komplekt / Комплект автомобильни щипки / Set spona za vozila / Komplek spojnica za automobile / Κλιπς ταπεταρίας / Kit de remaches de cache / Set di clip per carrozzeria / Luvas de nitrilo laranja / Ensemble d'épingles auto / Auto pinnen



Ref.	☞	EAN
11-952	0/28	5907558436990

x300

OPEL



Ref.	☞	EAN
11-953	0/28	5907558437003

x345

PEUGEOT



Ref.	☞	EAN
11-954	0/28	5907558437010

x308

FIAT



Ref.	☞	EAN
11-955	0/28	5907558437027

x350

VOLVO



Ref.	☞	EAN
11-956	0/28	5907558437034

x408

HONDA



Ref.	☞	EAN
11-957	0/28	5907558437041

x418

MAZDA

Zestaw spinek samochodowych

Car pins / Auto-Körper-Clipsset / Кліпси кріплення обшивки / Набор кліпс кріплення обшивки / Gépkoisci rögzítő patent készlet / Set de clipuri auto / Sada přičhytek čalounění / Súprava sponiek do auta / Set avtomobilskih sponk / Avtomobilnių tvirtinimo elementų rinkinys / Arşivuma stiprinājumi komplekts / Autotihvide komplekt / Комплект автомобильни щипки / Set spona za vozila / Komplet spojnica za automobile / Κλίπς ταπεταρίας / Kit de remaches de cache / Set di clip per carrozzeria / Luvas de nitrilo laranja / Ensemble d'épingles auto / Auto pinnen



x475

MAZDA

Ref.	☞	EAN
11-958	0/28	5907558437058



x370

MITSUBISHI

Ref.	☞	EAN
11-959	0/28	5907558437065



x415

MITSUBISHI

Ref.	☞	EAN
11-960	0/28	5907558437072



x290

BMW

Ref.	☞	EAN
11-961	0/28	5907558437089



x270

MERCEDES

Ref.	☞	EAN
11-962	0/28	5907558437096



x360

TOYOTA
LEXUS

Ref.	☞	EAN
11-950	0/28	5907558436976



x160

AUDI

Ref.	☞	EAN
11-964	0/28	5907558437119



x300

RENAULT

Ref.	☞	EAN
11-951	0/28	5907558436983

Zestaw spinek samochodowych

Car pins / Auto-Körper-Clipsset / Кліпси кріплення обшивки / Набор кліпс кріплення обшивки / Gépkości rögzítő patent készlet / Set de clipuri auto / Sada příchytěk čalounění / Súprava spinek do auta / Set avtomobilskih spank / Automobiliinių tvirtinimo elementų rinkinys / Apšuvima stiprinājumi komplekts / Autotivtvide komplekt / Комплект автомобильни щипки / Set sprava za vozila / Komplet spojnice za automobile / Κλιπς ταπεταρίας / Kit de remaches de coche / Set di clip per carrozzeria / Luvas de nitrilo laranja / Ensemble d'épingles auto / Auto pinnen



x255

VOLKSWAGEN

Ref.	📦	EAN
11-963	0/28	5907558437102

Nity

Rivets / Niete / Закленки / Закленки / Alu popszegecs készlet / Nituri / Njty / Nity / Zakovice / Kniedes / Kniedes / Neddítangid / Нумоое / Zakovice / Nita / Πριταίνα / Remaches / Rivetti / Rebites / Rivets / Klinknagels /

AL x400



Ref.	Ø [mm]	📦	EAN
11-970	2,4, 3,2, 4,0, 4,8	0/20	5907558437126

Nakrętki nierdzewne

Stainless steel nuts / Edelstahlmütern / Нержавеющие гайки / Гайки нержавіючі / Rozsadamentes anya készlet / Piulițe inoxidabile / Nerezové matice / Nehřzavející matice / Nerjavčie matice / Veržles, nerūdijancios / Nerūsējošie uzgriežņi / Roostevabast terasest mutrid / Нержавеи гайки / Nehřdajuce matice / Šrafovi od nerđajućeg čelika / Παξιμόδια ανοξείδωτα / Tuercas inoxidables / Dadi in acciaio inox / Porcas inox / Ecrous inoxydables / Roestvrije moeren

x146

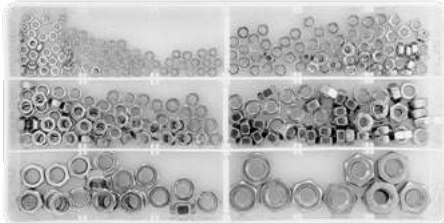

Ref.	📦	EAN
11-982	0/20	5907558435771

Podkładki miedziane

Coper pads / Unterlegscheiben aus Kupfer / Медные шайбы / Шайби мідні / Réz alátétek / Šaibe de cupru / Méděné podložky / Medené podložky / Medeninaste podložke / Varinēs tarpinēs / Vara starplikas / Vasest sebid / Медни шайби / Mesingasti podložci / Bakarne podložke / Хάλκινες ροδέλες / Arandelas de cobre / Rondelle in rame / Anéis de cobre / Rondelles en cuivre / Roestvrije onderringen



x300

Cu

Ref.	📦	EAN
11-971	0/10	5907558437133

Sprężyny

Springs / Federn / Пружини / Пружини / Rugó készlet / Arcuri / Pružiny / Pružiny / Vzmeti / Spyruokliu rinkinys / Atsperes / Vedrud / Пружини / Opruge / Opruge / Σετ ελαστέρα / Espirales / Molle / Molas / Ressorts / Veren

x200



Ref.	📦	EAN
11-980	0/20	5907558435757

Nakrętki samohamowne

Self-locking nuts / Selbstsichernde Muttern / Самоконтряться гайки / Гайки самоконтрруючі / Önzáró anyák / Piulițe cu auto-blocare / Samosvorné matice / Samosvorné matice / Samozaporne matice / Savaimė užsijksuojančios veržlės / Rašbremžjošie uzgriežņi / Iseblokeeruud mutrid / Самозаконтрращи гайки / Samokočie matice / Samokočie matice / Παξιμόδια αυτοσφραλιζόμενα / Tuercas autoblocantes / Dadi autobloccanti / Porcas autotrivantes / Ecrous freins / Zelfvreschiulende moeren

x146



Ref.	M	📦	EAN
11-972	4 - 12	0/20	5907558437140

Opaski zaciskowe

Band clips / Klemmschellen / Хомуты стяжные / Хомуты стяжні / Csőbilincs készlet / Cleme sopehline / Hadicové pásky / Fixačné pásky / PVC vezice / Užsradéjas / Savilcéji / Rihmaklamber / Kabeľnia preveržni / Stezne trake / Pvc vezice / Καλλήρα ούφιέρης / Bridas / Fasce con morsetto / Cintos p. grampear / Bride de serrage / Klembanden

x34



Ref.	☞	EAN
11-981	0/20	5907558435764

Korki z uszczelkami miedzianymi

Drain plugs and cover pads / Verschlußschrauben mit Kupferdichtungen / Набор медных прокладок и пробок / Набор мідних прокладок і корків / Menetes dugó és rézaláték készlet / Vuusoane cu garnituri din cupru / Zátky s měděným těsněním / Zátky s medenými tesneniami / Cepi za medeninastimi tesnilni / Varginiai katščiai ir tarpinės / Väciņi ar vara starplikām / Vasktīhdēdēga korgid / Пробки за усмочвае с медуи уплотнения / Затварачи с месингастим бртвана / Komplet čepova sa bakarnim zaprtvicama / Σετ χάλκινων παρεμβυσμάτων και ταπών / Tapones con juntas de cobre / Tappi con guarnizioni in rame / Tappões com anéis de cobre / Bouchons avec joints en cuivre / Krukken met messing dichting

x534



Ref.	☞	EAN
11-974	0/10	5907558437164

Pierścienie segera

Seeger rings / Seeger-Ring / Сталопрне кольца / Kĺncyka staloporni / Seeger gyűrűk / Inele Seeger / Segerové kružky / Segerane kružky / Seger obroči / Žiedatí Segera / Àrèjie un iekšèjie sprostgrèdzeni / Seeger ringid / Зезерки / Uskožnici / Seeger prstenovi / Διακτύλια συγκράτησης / Anillos seger / Anelli Seeger / Anéis Seeger / Anneaux élastiques / Seeger ringen

x300

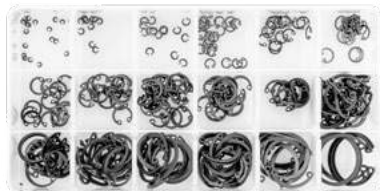

Ref.	☞	EAN
11-975	0/20	5907558437171

Zestaw smarowniczek

Set of lubricating nipples / Ölerset / Набор маслѐнок / Набор оливиць / Zsírszõszem készlet / Set de cãni de ungere / Sada mazniciek / Súprava mazniciek / Komplet mazalnic / Suteripio dozatori / Kompletas / Eļļas kanniņu komplekts / Måderprintsida komplekt / Комплект рѣчни маслѐнки / Set dozera za mazivo / Komplet maziva / Σετ ελαιοδεξιμενών / Juego de pistolas engrasadoras / Completo di punti di ingrassaggio / Kit de lubrificadores / Jeu de tubulure de graissage / Set van smeernippels

x110



Ref.	☞	EAN
11-973	0/20	5907558437157

Uszczelki (O-ring NBR)

Seals (O-ring NBR) / Dichtungen (O-ring NBR) / Прокладки (O-ring NBR) / Прокладки (O-ring NBR) / Tömítés készlet (o-gyűrű nbr) / Garnituri (O-ring NBR) / Těsnění (O-ring NBR) / Tesnenia (O-ring NBR) / Tesnila (O-ring NBR) / Tarpines (O-ring NBR) / Blives (O-ring NBR) / Tihendid (O-ring NBR) / Тарништу (O-ring NBR) / Brtvila (O-ring NBR) / Zaprtivke (O-ring NBR) / Ταπισώχες (O-ring NBR) / Juntas de calafateo (O-ring NBR) / Guarnizioni (O-ring NBR) / Vedantes (O-ring NBR) / Joints (O-ring NBR) / Dichtringen (O-ring NBR)

x225



Ref.	☞	EAN
11-977	0/20	5907558437195

Koszulki termokurczliwe

Heat shrink sleeves / Wärmeschrumpfende Hüllen / Термосадочне рукава / Рукави термосадочни / Zsugorcsó készlet / Manşone termocontractabile / Teplom smržitelné rukávy / Teplom zmržitelné návleky / Toplotno-skrčne spojke / Termišakai susitraukiančios rankovės / Termoručijas uzmaivas / Termokahanevad sãrgid / Termosuoameku ulapaxy / Termo savlitjivi rukavi / Rukavi koji se skupljaju na toploti / Θερμοσυστρίψιμα μοναδικά καλωδίων / Mangas termocontractables / Guaine termorestringenti / Mangas termoretrãcteis / Gaines thermorétractables / Thermokrimp mouwen

x127



Ref.	☞	EAN
11-978	0/20	5907558437201

Uszczelki (O-ring HNBR)

Seals (O-ring HNBR) / Dichtungen (O-ring HNBR) / Прокладки (O-ring HNBR) / Прокладки (O-ring HNBR) / Tömítés készlet (O-gyűrű hnbr) autóklimához / Gorturti (O-ring HNBR) / Těsnění (O-ring HNBR) / Tesnenia (O-ring HNBR) / Tesnila (O-ring HNBR) / Tarpinés (O-ring HNBR) / Blives (O-ring HNBR) / Tihendid (O-ring HNBR) / Гарнитура (O-ring HNBR) / Brtvila (O-ring HNBR) / Zapivke (O-ring HNBR) / Ταμνούξες (O-ring HNBR) / Juntas de calafateo (O-ring HNBR) / Guarnizioni (O-ring HNBR) / Vedantes (O-ring HNBR) / Joints (O-ring HNBR) / Dichtringen (O-ring HNBR)



x270

Ref.	☞	EAN
11-976	0/20	5907558437188

Podkładki miedziane

Coper pads / Unterlegscheiben aus Kupfer / Медные шайбы / Шайби мідні / Réz alátétek / Saibe de cupru / Měděné podložky / Medené podložky / Medeninaste podložke / Varinés tarpinés / Vara starplikas / Vasset seibid / Медни шайби / Mesingasti podložci / Bakarne podložke / Халкун роделе / Arandelas de cobre / Rondelle in rame / Anéis de cobre / Rondelles en cuivre / Roestvrije onderingen



x150

Ref.	☞	EAN
11-979	0/20	5907558435740

Uszczelki

Seals / Dichtungen / Прокладки / Прокладки / Tömítések / Gorturti / Těsnění / Tesnenia / Tesnila / Tarpinés / Blives / Tihendid / Гарнитура / Brtvila / Zapivke / Ταμνούξες / Juntas de calafateo / Guarnizioni / Vedantes / Joints / Dichtringen

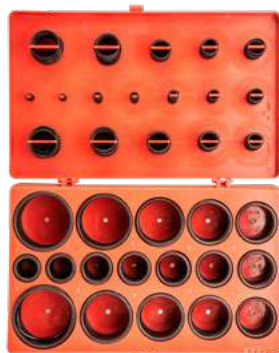

x419

Ref.	☞	EAN
11-983	1/20	5907558435788

Opaska ślimakowa

Hose clamp / Schneckenschelle / Хомут червячный / Хомут гвинтований / Tömítőbilincs / Bråtåta cu melc / Sneková sprona / Stahovacia páska konová / Objemka na poľžu / Sagarža / Gliemežsavnicejs / Toruklamter / Скоба с червячна резьба / Objumica sa ružnim navojem / Šelna / Οβονωτάς σφιγκτήρας σωλήνα / Bridas / Fascetta a vite / Abraçadeira caracol / Collier de serrage



Ref.	Ø [mm]	N	☞	EAN
11-400	8-12 / 9 mm	3	0/200	5907558420425
11-401	10-16 / 9 mm	3	0/200	5907558420432
11-402	12-20 / 9 mm	3	0/200	5907558420449
11-403	16-27 / 9 mm	3	0/200	5907558420456
11-404	20-32 / 9 mm	3	0/200	5907558420463

Chwytek magnetyczny

Magnetic holder / Magnetgreifer / Магнитный захват / Тримач магнітний / Mágneses csavarkiszédő teleszkópos / Graiffr magnetic / Magnetická úchytko / Magnetický zdvihák / Magneto držalo / Magnētinis laikiklis / Magnētiskais satvērējs / Magnethaars / Магнетен захват / Magnetska hvatajka / Магнетни hvatač / Μαγνητική αρραγή / Agarardor magnética / Supporto magnetico / Çaçamba magnética / Preneuse magnétique / Magnetisch houder



Ref.	☞	EAN
11-610	0/200	5907558418569



Ref.	☞	EAN
11-611	0/100	5907558418576

Lusterko inspekcyjne

Inspection mirror / Inspektionsspiegel / Зеркало инспекционное / Dvernalce inspekcijne / Vizsgálótükör teleszkópos nyéllel / Oglindă de inspecție / Zrcadlo pro inspekční kontroly / Inšpekčné zrkadlo / Kontrolno ogledalo / Vaizdo veidrodēlis / Inspekcijas spoguļis / Kontrollspiegel / Контролно оєлєдатель / Kontrolno ogledalo / Ogledalo za inspekciju / Καθρέπτη εξέχου / Espejo de inspección / Specchietto per ispezione / Espelho de inspeção / Mirior d'inspection / Inspectiespiegel



Ref.	☞	EAN
11-612	0/200	5907558418583

Miska magnetyczna

Magnetic tray / Magnetschüssel / Поддон магнитный / Поддон магнітний / Mágneses táj, rozsdamentes / Tava magnetica / Magnetická miska / Magnetická miska / Magneta posoda / Magnetinis dubenėlis / Magnētiskais trauks / Magnetkauss / Магнитен картър / Magnetska posuda / Magneta činja / Μαγνητικός βιάκος / Platu magnética / Vassoio magnetico / Tacho magnética / Réceptien magnétique / Magnetische orvangbak

25 years WARRANTY



Ref.	L x W [mm]	⊞	EAN
11-614	245 x 145	0/24	5907558419702

Kamera inspekcyjna

Inspection camera / Inspektionskamera / Инспекционная камера / Камера инспекційна / Vizsgálókamera / Camera de inspectie / Inspektinė kamera / Kontrolná kamera / Inspekcijska kamera / Inspekcine kamera / Inspekcijas kamera / Инспекционная камера / Inspekcijska kamera / Kamera za inspekciju / Κάμερα επιθεώρησης / Cámara de inspección / Telecamera d'ispezione / Câmara de inspeção / Camera d'inspection / Inspectie camera



Ref.	⊞	EAN
11-607	1/10	5907558436426

Przewody rozruchowe

Booster cables / Akku-Zusatzeleitungen / Стартовые провода / Шнури аварійного пуску акумулятора / Indítókábel rész / Conductor de avarie pentru acumulator / Kabely pro nouzové startování k akumulátoru / Potomné káble do akumulátoru pre núdzový štart / Vízjalni kabli / Automobilio užvedimo laidai / Palaišanas vadi akumulātoram / Aku anvarijuhmed / Аварійні проводниці за акумулятора / Rezervni kablovi za akumulator / Hitni kabl za akumulator / Καλώδια έκτακτης ανάγκης για ηλεκτρικό οασουρευτή / Cables puente para la batería / Cavi di emergenza per la batteria / Cabos de emergência para bateria / Câbles de démarrage pour batterie

2.5m
Cu



Ref.	A max	⊞	EAN
11-834	200	0/6	5907558436815
11-836	600	0/5	5907558436822

Tester akumulatorów

Battery load tester / Batterietester / Тестер батарею / Тестер акумулятора / Akkumulátor tesztelő / Tester de încercare a bateriei / Tester baterii / Tester batterie / Tester akumulatorja / Akumulatoriaus baterijos testeris / Akumulatoru bateriju testeris / Aku tester / Тестер на батареяма / Ispitivač baterije / Испитивач батерије / Ελεγκτής φορτίου μπαταρίας / Comprador de carga de batería / Tester di carico della batteria / Testador de carga da batería / Testeur de charge de batterie / Acculadtester



Ref.	A max	⊞	EAN
11-984	100	1/10	5907558452402
11-985	125	1/10	5907558452419



Ref.	⊞	EAN
11-986	6/36	5907558452419

Urządzenie rozruchowe "Jumpstarter"

Boot device "Jumpstarter" / Startgerät "Jumpstarter" / Загрузочное устройство "Jumpstarter" / Завантажувальний пристрій "Jumpstarter" / Boot eszköz "Jumpstarter" / Dispozitiv de pornire „Jumpstarter” / Spouštěcí zařízení „Jumpstarter” / Zavádzacie zariadenie „Jumpstarter” / Zagonska naprava „Jumpstarter” / Ikrovos jengingys „Jumpstarter” / Sākņēšanas ierīce „Jumpstarter” / Buulimisseade „Jumpstarter” / Стартовое устройство „Jumpstarter” / Uredaj za pokretanje „Jumpstarter” / Уреджaj за покретанье система „Jumpstarter” / Συσκευή εκκίνησης „Jumpstarter” / Dispositivo de arranque „Jumpstarter” / Dispositivo di avvio „Jumpstarter” / Dispositivo de inicialização „Jumpstarter” / Périphérique de démarrage „Jumpstarter” / Opstartapparaat „Jumpstarter”



14 000 mAh
44.8 W
LiFePo4 long life battery
MAX 400A (more cars)
USB 1A / 2A power bank
MAX 2.5A
LED light

Ref.	⊞	EAN
11-997	1/4	5907558452419

NEO TOOLS

NARZĘDZIA WARSZTATOWE

WORKSHOP TOOLS

ИНСТРУМЕНТЫ МАСТЕРСКОЙ

Refraktometr

Refraktometer / Refraktometer / Рефрактометр / Рефрактометр / Refraktometer / Refraktometru / Refraktometer / Refraktometer / Refraktometras / Refraktometers / Refraktometeer / Рефрактометр / Refraktometer / Refraktometer / Διαθλασιμετρο / Refraktometro / Rifraktometro / Refratometro / Réfractomètre



Ref.	☞	EAN
11-270	0/50	5907558436020

Próbnik elektryczny samochodowy

Car voltage tester / Kfz-Spannungsprüfer V / Индикатор напряжения / Индикатор напруги автомобільний / Jármű fázisceruza / Sonda de luat probe la instalatii electrice la automobile / Zkoušečka napětí autoelektrikářská / Autoskušáčka / Preizkuševalac napetosti za avtomobile / Elektroninis testeris automobiliams / Automašinas elektrības testeris / Auto elektritester / Автомобилен фазмер / Električni ispitivač napona / Automobiliški električni tester / Σωακείη ένδειξης τάσης / Prbadador eléctrico para coches / Tester per auto / Testador de tensão para carros / Testeur électrique automobile / Elektrische wagen meetkap

6-24V



Ref.	☞	EAN
11-832	12/240	5907558420418

Latarka czołowa

Latarka czołowa / Headlamp / Stirnlampe / Фонарь налобный / Лихтарик на чільний / Fejlampa / Лампа сар / Čelní baterka / Lampa čelová / Čelna svetilka / Žibintuvélis / Lukturitis uz pieres / Esilatern / Лампа на глаза / Lampra za glavu / Rucna lampra / Φακός κεφαλής / Linterna de frente / Lampada frontale / Lanterna de testa / Torche frontale / Hoofdzaklamp

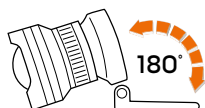

100% 400lm
⌚ 2h
50% 200lm
⌚ 5h
stroboscope



Ref.	☞	EAN
99-200	10/40	5907558425505



1st click:
☞ 40% max 2 h
2nd click:
☞ 10% max 6 h
3rd click: OFF
press 2 seconds:
☞ 100% max 40 sec.
double click:
☞ STROBE



Ref.	☞	EAN
99-027	10/80	5907558451252



1st click: ☞ 70% max 4 h
2nd click: ☞ 45% max 4 h
3rd click: ☞ 12% max 6 h
press fast 2 times:
☞ 100% max 2.5 h
+ click 1: ☞ STROBE
+ click 2: ☞ SOS
press 2 seconds:
☞ Red
+ click 1: ☞ STROBE
+ click 2: ☞ Blue
long press: OFF



Ref.	☞	EAN
99-028	0/50	5907558451269



1st click: ☞ 40% max 5 h
2nd click: ☞ 15% max 9 h
3rd click: ☞ 3% max 60 h
4th click: OFF
press 2 seconds:
☞ 100% max 40 sec.
double click:
☞ STROBE



Ref.	☞	EAN
99-029	10/40	5907558451276

Latarka

Torch / Taschenlampe / Фонарик / Личмарук / Aluminium 2x21-ben zseblámpa/vizsgátlámpa / Lanterna / Bateria / Lampa / Svetilka / Žibintuvēlis / Lukturis / Pāleli / Фенерче / Baterijska / lampa / Lampa / Фонарь / Linterna de mano / Torcia / Lanterna / Torche / Zaklamp

- 1st click: 100% max 8 h
- 2nd click: 50% max 13 h
- 3rd click: SIDE max 8 h
- 4th click: RED max 6 h
- 4th click: RED STROBE max 9 h

EDC compatible
3W 300 max lm
CREE XPB + COB LED
ALUMINIUM BODY
BATTERY 1-100 3.7V 2000mAh
3h charging
POCKET CLIP



ROTATING
MAGNETIC
USB charging

Ref.	⊞	EAN
99-034	50/100	5907558451443

3W 200 max lm
COB LED
ALUMINIUM BODY
X3 AA
IP20



Ref.	⊞	EAN
99-032	0/75	5907558451306

- 1st click: 100% min 3 h
- + 1st click: 40% max 7 h
- + 2nd click: 10% max 25 h
- 2nd click: OFF
- click + hold: STROBE

10W 1000 max lm
ZOOM
250 m
BATTERY Li-ion 3.7V 2200mAh
OSRAM P9 LED
BATTERY INDICATOR
USB charging cable
ALUMINIUM BODY
4.5h charging
IPX4



Ref.	⊞	EAN
99-035	20/40	5907558451450

20W 1500 max lm
ZOOM
250 m
X6 AA
CREE XP-HP50.2 LED
ALUMINIUM BODY
3h work time
IPX4



- 1st click: 100%
- 2nd click: OFF
- 3rd click: 20%
- 4th click: OFF
- 5th click: SOS strobe

light press: **cycle modes**

Ref.	⊞	EAN
99-036	4/24	5907558451467

30W 3300 max lm
ALUMINIUM BODY
220 m
BATTERY Li-ion 3.7V 4000mAh
OSRAM P9 LED
USB charging cable
6h charging
IPX4

- 1st click: 3% max 60 h
- 1st click: 10% max 10 h
- 1st click: 40% max 3 h
- 4th click: OFF
- press 2 seconds: 100% max 45 sec.
- double click: STROBE



Ref.	⊞	EAN
99-037	20/40	5907558451474

3W 100 max lm
X2 AAA
CREE XPB2 LED
POCKET CLIP
ALUMINIUM BODY
5h work time
IP54



Ref.	⊞	EAN
99-046	8/96	5907558452372



NARZĘDZIA WARSZTATOWE

WORKSHOP TOOLS

ИНСТРУМЕНТЫ МАСТЕРСКОЙ

Lampa warsztatowa

Workshop lamp / Werkstattlampe / Лампа переносная / Лампа переносна / Steklámpa / Lampă atelier / Dilenská lampa / Dielenská lampa / Delavniška svetilka / Lampa dirtbuvēms / Pārnesājamā lampa / Töökaja lamp / Лампа работна / Radna lampa / Rādna lampa / Lámpa de taller / Lâmpada de oficina / Lâmpada de oficina / Lampe d'atelier / Werkplaatlamp

1st click:
100%
max 1.5 h

2nd click:
50%
max 3 h

3rd click:
100%
max 3 h

4th click: OFF

press 2 seconds:
RED LIGHT
max 3 h

+ click 1:
RED STROBE

+ click 2: OFF



Ref.	⊞	EAN
99-041	0/50	5907558452327

1st click:
max 3.5 h

2nd click: OFF

3rd click:
max 6 h

4th click: OFF



Ref.	⊞	EAN
99-042	0/24	5907558452334

1st click:

100%
max 2h

2nd click:

30%
max 7h

3rd click:
OFF



Ref.	⊞	EAN
99-043	0/24	5907558452341
99-044	0/16	5907558452358



Ref.	⊞	EAN
99-047	0/8	5907558452389

1st click:

50%

2nd click:

100%

3rd click:

RED STROBE



Ref.	⊞	EAN
99-045	50/100	5907558452365

1st click:
100% max 3.5 h

2nd click:
50% max 6 h

press 2 seconds:
FLASHING



Ref.	⊞	EAN
99-048	1/4	5907558452396

Naświetlacz

Floodlight / Scheinwerfer / Прожектор / Прожектор / Diszkvilágítás / Proiector / Světlo / Svetlo / Reflektor / Průžektorius / Floodlight / Floodlight / Прожектор / Reflektor / Φθοδόνευμα / Προβολέας / Luz de inundación / Projectore / Floodlight / Projecteur / Schijnwerper

- 1st click: 100% max 3 h
- 2nd click: OFF
- 3rd click: 20% max 10 h
- 4th click: OFF
- 5th click: STROBE
- 6th click: OFF



Ref.	📦	EAN
99-039	0/12	5907558452303

- 1st click: Large LED 100% max 2 h
- 2nd click: Small LED 100% max 5 h
- 3rd click: OFF
- press 3 seconds: Both LEDs 100% max 2 min



Ref.	📦	EAN
99-040	10/20	5907558452310

Zestaw bezpieczników samochodowych

Car fuse / Set von Auto-Sicherungen / Набор автомобильных предохранителей / Набор запобіжників автомобільних / Gércsikbiztosíték szett / Set de siguranțe auto / Sada pojistek do auta / Sada automobilových poistiek / Set avtomobilskih varovalk / Automobiliinių saugiklių rinkinys / Autoašišni drošinātāji / Autokaitismete komplekt / Комплект автомобильни предпазители / Set osigurača za auto / Komplet svěčka za automobil / Σετ ασφάλειες αυτοκινήτου / Conjunto de fusibles de coche / Set di fusibili per auto / Kit de fusíveis de automóveis / Ensemble de fusibles auto / Auto bougies



Ref.	📦	EAN
11-991	50/200	5907558435795



Ref.	📦	EAN
11-992	50/200	5907558435801

Mata serwisowa na błotniki, magnetyczna

Car body servis cover, magnetic / Servicematten für Kotflügel, magnetisch / Накладка магнитная на крыло / Накладки магнітні до брызкошита / Mágneses sárvédő takaró / Rogajini servicii pentru aripa, magnetice / Ochranné přehozy na blatníky, magnetické / Servisné rohože pre blatníky, magnetické / Servisne obloge za blatnike, magnetne / Apsauginė magnetinė danga ant sparno / Mašinas spārta magnētiskais paklājs instrumentiem / Parilaudade hooldusmattid, magnetiseerd / Магнитно покрывало за калцишу / Servisne mate za blatbrane, magnetske / Servisne podloge za branike, magnetne / Магнітні подія фітспі / Alfombras de servicio para guardabarras, magnéticas / Stuoie per manutenzione sui parafranghi, magnetiche / Coberturas magnéticas para para-lamas / Bâches de garde-boue magnétiques / Service matten voor spatlappen

x88



Ref.	📦	EAN
11-993	0/20	5907558435818



120x100 cm

Ref.	📦	EAN
11-718	0/20	5907558437079

NEO
TOOLS

NARZĘDZIA WARSZTATOWE

WORKSHOP TOOLS

ИНСТРУМЕНТЫ МАСТЕРСКОЙ

Wiągarka łańcuchowa

Chain block / Kettenwinde / Лебедка цепная / Тяга панцюгова / Láncoos emelő / Trolu cu lant / Řetězový kladkostroj / Refázový zdvihák / Veržna dvigalka / Grandininé gerve / Къден винча / Kettvints / Вержина лебедка / Lančani podizač / Lančana dizalica / Βαρούλιο με αλυσίδα / Cabria de cadena / Paranco a catena / Guincho de corrente / Treuil à chaîne / Kettingtakel



Ref.	[t]	L [m]	⊞	EAN
11-760	1	3	0/1	5907558418385
11-761	2	3	0/1	5907558418392
11-762	3	3	0/1	5907558418408
11-763	5	3	0/1	5907558418415

Podnošník stúpkový

Bottle jack / Säulenhebergerät / Домкрат гидравлический бутылочный / Домкрат пляшкочный / Palackemető / Cric coloană / Zvedák pistový / Stĺpkový zdvihák / Dvigalka / Hidraulinis keltuvus / Mastu raseläjs / Latt-lungraud / Колонен подемник / Stupna dizalica / Stubasta dizalica / Γρύλος υδραυλικός μπουκάλας / Gato hidráulico de botella / Sollevatore a bottiglia / Elevador com calunas / Cric bouteille / Pahlhjoesteel



Ref.	Fmax [t]	Hmax [mm]	Hmin [mm]	⊞	EAN
11-700	2	308	158	1/6	5907558436648
11-702	5	468	212	0/6	5907558416893
11-701	8	390	205	1/4	5907558436655
11-705	20	521	241	0/4	5907558416923

Podnošník pneumatyczny

Air floor jack / Werkstattheber / Пневматический домкрат / Кран гаражный / Pneumatikus légrárnás emelő / Cric de atelier / Dilenský zvedák / Dielenský zdvihák / Dvigalka / Keltuvus dirbtuvėms / Profesionālais raselājs / Töökojatungraud / Пневматич / Radionička dizalica / Radionička dizalica / Γερανός για γκαράζ / Gato de taller / Cric da oficina / Elevador de oficina / Vérin d'atelier / Werkplaats hjoesteel /



Ref.	⊞	EAN
11-735	0/1	5907558436723

Podnošník przesuwny

Floor jack / Schiebeheber / Домкрат подкатной / Домкрат / Aluminium hydraulikus krokodilemő / Cric de podea / Pfenosny zvedák / Zdvihák hydraulický vozík / Hidraulčna dvigalka / Domkratas / Raselājs / Tungraud / Кран / Hidraulčna auto dizalica / Hidraulčna auto dizalica / Γρύλος τράλλει / Gato hidráulico / Sollevatore a carrello / Elevador de deslize / Cric mobile / Schuifhjoesteel



Ref.	[t]	⊞	EAN
11-730	1.25	0/1	5907558416930



Ref.	[t]	⊞	EAN
11-731	2.5	0/1	5907558416947



Ref.	[t]	⊞	EAN
11-732	3.0	0/1	5907558436716

Podstawki pod samochód

Jack stands / Kfz-Unterlagen / Подставки автомобильные / Підставка під автомобіль / Emelő bak / Support de redicारे / Podpěra panenka / Podpěra panenka / Podstavki za hidravlično dvigalko / Automobilonis domkrats / Paliktnis zem auto / Tungtraa alused / Стойки за кола / Držaci za auto dizalicu / Drzac za auto dizalicu / Τρίποδες σταθέρως / Soporte para coche / Cavalletti di sollevamento / Soporte para carro / Supports pour voiture / Autosteunen

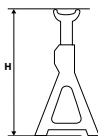

x2

Ref.	[t]	H [mm]	☞	EAN
11-750	3	295 - 415	1/1	5907558418361
11-751	2	278 - 423	1/1	5907558418378

Leżanka warsztatowa

Car creeper / Werkstattliege / Лежанка рабочая / Візюн на роликах для / Роботи під автомобілем / Szekelőgyű, összecsukskható / Szelzong de atelier / Dilenská lehátka / Montážne ležadlo / Delavniški ležalnik / Sulankstoma lava, airbtuvems / Darba gultamkrēsls / Veeevalus / Мониторсно килимче / Radionički ležalnik / Radionički kauč / Ζανκιάτρα ουνεργείου / Camilla de taller / Lettino sottomacchina / Carrinho de oficina / Divan d'atelier / Werkplaatsbank



Ref.	☞	EAN
11-600	0/1	5907558418347



Ref.	☞	EAN
11-601	1/1	5907558445282

Stojak na silnik

Engin stand / Motorhalter / Стенд для ремонта двигателя / Стенд для ремонту двигуна / Motorszerelő állvány / Stativ pentru motor / Stojan na motor / Stojan na motor / Stajalo za motor / Variklio stovas / Dzinēja remonta statīvs / Motoristend / Stojak za daveaten / Stalak za motor / Bāzē spāksveķis kvīņģīrģu / Soporte para motor / Cavalletto supporto motore / Supporte de motor / Support moteur / Motor onderstel



Ref.	☞	EAN
11-710	0/1	5907558436662

Podnośnik do skrzyń biegów

Transmission jack / Getriebehēber / Трансмиссионная стойна / Стійна трансмісійна / Sebessęgváltó emelő / Cric pentru cutia de viteze / Zvedák pŕevodovek / Zdvih prevodovky / Dvigalo za menjalnik / Povaru džez keltuvus / Ātrumkārbas domkrats / Kaigukasli tungtraud / Трансмиссионен подемник / Podzaca džez mjenjača / Dizalica za menjač brzina / Σαοανόγυρλος / Elevador de caja de engranajes / Martinetto per scatole del cambio / Elevador da caixa de velocidades / Jack de transmission



Ref.	☞	EAN
11-712	0/1	5907558436679



Ref.	☞	EAN
11-711	1/1	5907558445534

Podnośnik warsztatowy

Shop crane / Werkstattheber / Внутрицеховой кран / Кран гаражный / Műhelydarú, motorkiemelő zsrít / Cric de atelier / Dilenský zdvíhák / Dieļenský zdvihāks / Dvigalka / Keltuvos dirbtuvėms / Profesionālais pacelājs / Töökojutungraud / Подъёмоч / Radionička dizalica / Radionička dizalica / Γερανός για υαράκι / Gato de taller / Gruetta / Elevador de oficina / Vérin d'atelier / Werkplaats hystoestel



Ref.	[t]	H [mm]	⊞	EAN
11-720	2	25-2382	0/1	5907558419665

Stół warsztatowy

Work bench / Werkstattbank / Стол-верстак / Верстак / Állítható munkapad / Tejghea timplárie / Dilenský stůl / Stolik pracovný / Delavníška miza / Darbastalis / Darba galds / Tööpink / Рабочня маса / Stol radionički / Radni sto / Πάγκος εργαλεία / Banco de trabajo / Banco da lavoro / Mesa de oficina / Etibli d'atelier / Werkplaatstafel



Ref.	[mm]	⊞	EAN
11-716	1500 x 780 x 830	0/1	5907558436693

Prasa hydrauliczna

Hydraulic press / Hydraulische Presse / Гидравлический пресс / Прес гидравлический / Hidraulikus prés / Presă hidraulică / Hydraulický lis / Hydraulický lis / Hidravlična stiskalica / Hidraulinis presas / Hidraulická prese / Hidrauliline press / Гидравлична преса / Hidravlična preša / Hidravlična presa / Υδραυλική πρέσα / Prensa hidráulica / Prasa idraulica / Prensa hidráulica / Presse hydraulique /



20T

0-905
mm

Ref.	⊞	EAN
11-714	0/1	5907558436686

Zestaw do ściągania i instalowania łożysk

Bearing removal and fitting kit / Radlager-Werkzeug-Satz / Набор для снятия/установки подшипников / Набор для зняття та встановлення вальниць / Csapágyszereelő szerszámkészlet / Set de dispozitive de scos si de instalat lagare / Sada pro výměnu a montáž ložisek / Súprava na demontáž a inštaláciu ložísk / Set za snemanje in montažo ležajev / Guoliu montavimo kompleksas / Gultņu novikšanas un instalēšanas komplekts / Laagrite eemaldamise ja paigaldamise komplekt / Комплект за стьажане u uсталаванне на лагэру / Set za skidanje i instaliranje ležaja / Pribor za skidanje i instaliranje ležišta / Set tonobéttás/árhozás/ trébező / Juego para extraer e instalar rodamientos / Kit estrazione e montaggio cuscinetti / Jogo de ferramentas para remover e instalar rolamentos / Jeu d'arrache-roulement et de monte-roulement / Set voor demontage en installatie van laggers



50-88
mm

Ref.	Ø [mm]	⊞	EAN
11-690	50, 55, 60, 64, 67, 70, 72, 74, 75, 78, 82, 84, 88	1/2	5907558436624

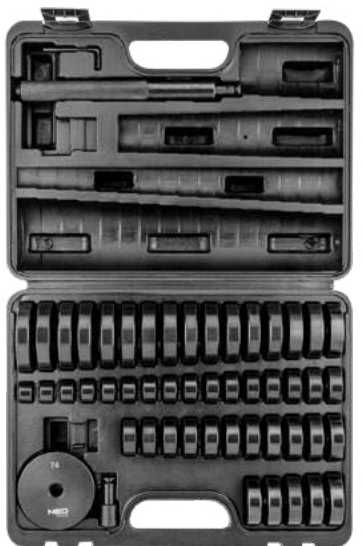

18-65
mm

Ref.	Ø [mm]	⊞	EAN
11-691	18, 19, 20, 21, 22, 23, 24, 25, 26, 27, 28, 29, 30, 31, 32, 33, 34, 35, 36, 37, 38, 39, 40, 41, 42, 43, 44, 45, 46, 47, 48, 49, 50, 51, 52, 53, 54, 55, 56, 57, 58, 59, 60, 61, 62, 63, 64, 65	1/1	5907558436631

Szafka narzędziowa

Tool cabinet / Werkzeugschrank / Шкафчик для инструментов / Шкафа инструментальна / Műhelykocsi / Dulap pentru scule / Skříňka na nářadí / Skrinika na náradie / Omatca za orodje / Irankiü spintele / Instrumentu skapis / Тооristаккап / Шкафче за инструменти / Ormar za alate / Ormaric za alatke / Нтоућандки уа ерүәкәя / Armario de almacenaje para herramientas / Carrello porta utensili / Estante p. Ferramentas / Rmoire à outils / Gereedschapskast

Duży blat roboczy z antypoślizgową powierzchnią
Large working tabletop with antislip surface
Большая рабочая поверхность с антискользящим покрытием

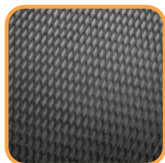

Zamek centralny (w komplecie 2 klucze)
Tools secured with central lock (2 keys in set)
Центральный замок, предохраняющий инструмент (2 ключа в комплекте)



Blokada szuflady zabezpiecza przed wysuwaniem się podczas prowadzenia wózka
Drawer lock protects against opening when driving the trolley
Блокиратор ящиков предохраняет их от выдвижения во время перемещения тележки



Boczny uchwyt do prowadzenia szafki
Side handle to manoeuvre with the cabinet improves comfort of use
Боковая ручка для ведения тележки повышает комфорт эксплуатации



Długotrwała żywotność, duży udźwieg, płynny suw zapewnione dzięki prowadnicom kulkowym

Long lifetime, great capacity, smooth slide thanks to ball guides

Долгий срок службы, высокая грузоподъемность, плавное перемещение - благодаря шариковым направляющим



Hamulec zwiększający bezpieczeństwo. Koła z trwałego PVC
Brake improves safety. Wheels made of durable PVC
Тормоз, повышающий безопасность. Колеса из прочного ПВХ



Całocisłowo wysuwalne szuflady ułatwiające wyjmowanie narzędzi. Wnętrze wyścielane miękką gąbką zabezpiecza przed rysowaniem i przesuwaniem narzędzi

Fully extendable drawers for easier picking out tools

Ящики выдвигаются в полном объеме, что облегчает выемку инструмента



Ref.	D [mm]	W [mm]	H [mm]	capacity [kg]	⚙️	EAN
84-221	460	680	1030	280	0/1	590755842238
84-222	460	680	1030	280	0/1	590755842245

Szafka narzędziowa

Tool cabinet / Werkzeugschrank / Шкафчик для инструментов / Шафа інструментальна / Műhelykocsi / Dulap pentru scule / Skříňka na nářadí / Skrinika na náradie / Omalica za orodje / Įrankių spintelė / Instrumento skapis / Тööriistakapp / Шафче за инструменти / Ormar za alate / Ormaric za alatke / Όργανο για εργαλεία / Armario de almacenaje para herramientas / Carrello porta utensili / Estante p. Ferramentas / Rmoire à outils / Gereedschapskast



Zamek centralny – zapewnia bezpieczeństwo narzędzi
Central locking - provides security tools
Центральный замок – обеспечивает безопасность инструментов



Wytrzymały blat z ABS z gumowanymi uchwytami, dedykowanym miejscem na imadło oraz kieszeniami na drobniaki i wkrętki
Durable top of ABS with rubberized handles, a dedicated space for vice and pockets for small items and screwdrivers
Прочная столешница с системой ABS с резиновыми ручками, выделенным местом для тисков и карманами для мелких предметов и отверток



Blokada szuflad – zapewnia bezpieczeństwo w czasie transportu
Locking drawers - provides security during transport
Блокада для ящиков – обеспечивает безопасность во время транспортировки



Szerokie prowadnice kulkowe – zapewniają płynny ślizg
Wide ball guides - provide a smooth glide
Широкие шариковые заборы – обеспечивают плавное скольжение



Antyobciwowe naroża
Protective bumper corners
Уголки с накладками, защищающими от повреждений



Dedykowane miejsce na imadło
Special place for vice
Специальное место для тисков

Ref.	D [mm]	W [mm]	H [mm]	capacity [kg]	☑	EAN
84-223	480	780	750	200	0/1	5907558422276

149 elements

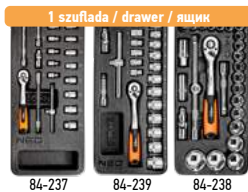

Ref.	D [mm]	W [mm]	H [mm]	capacity [kg]	☑	EAN
84-221+G	460	680	1030	280	0/1	5907558425840

Szafka narzędziowa

Tool cabinet / Werkzeugschrank / Шкафчик для инструментов / Шафа інструментальна / Műhelykocsi / Dulap pentru scule / Skříňka na nářadí / Skrinika na náradie / Omatnica za orodje / Įrankių spintelė / Instrumentu skapis / Τσούριστάκι για εργαλεία / Armario de almacenaje para herramientas / Carrello porta utensili / Estante p. Ferramentas / Rmoire à outils / Gereedschapskast

129 elements



84-237 84-238 84-236

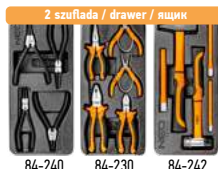

84-240 84-230 84-242



84-235 84-234 84-232



84-249

Ref.	D [mm]	W [mm]	H [mm]	capacity [kg]	☞	EAN
84-222+G	460	680	1030	280	0/1	5907558425857

126 elements

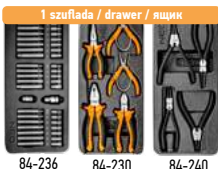

84-236 84-230 84-240



84-238 84-232 84-231



84-243 84-234 84-235



84-249

Ref.	D [mm]	W [mm]	H [mm]	capacity [kg]	☞	EAN
84-223+G	480	780	750	200	0/1	5907558427097

Wózek warsztatowy

Workshop trolley / Werkstattrollwagen / Тележка для инструмента / Вагок інструментальний / Műhely kocsi / Căruțor de atelier / Dilenský vozík / Dielenský vozík / Delavníški vozček / Vežimėtis dirbtuvėms / Instrumentu ratiņi / Тэакожакіру / Работна кољачна / Kolica za radionico / Radionička kolica / Καροτσά εργαλείων / Carrito de taller / Carrello portautensili / carrinho de oficina / Chariot d'atelier / Werkplaatskar



Ref.	D [mm]	W [mm]	H [mm]	capacity [kg]	☞	EAN
84-229	390	630	810	130	0/1	5907558435610
84-080-G87/f	460	680	880	200	0/1	5907558457803

Szafka narzędziowa



Tool cabinet / Werkzeugschrank / Шкафчик для инструментов / Шафа інструментальна / Műhelykocsi / Dulap pentru scule / Skříňka na nářadí / Skrinika na náradie / Omatnica za orodje / Įrankių spintelė / Instrumentu skapis / Τσούριστάκι για εργαλεία / Armario de almacenaje para herramientas / Carrello porta utensili / Estante p. Ferramentas / Rmoire à outils / Gereedschapskast



Ref.	D [mm]	W [mm]	H [mm]	capacity [kg]	☞	EAN
84-220	460	810	980	300	0/1	5907558427097

Haki

Hooks / Hacken / Κροχια / Гаки / Horgok / Cărlige / Háky / Skaby / Kljuke / Kablati / Āķi / Хаагид / Нюкы / Kuke / Kuke / Ганτζаи / Ganchos / Gancci / Anzais / Crochets / Haken

x3 40 mm

Ref.	L [mm]	☞	EAN
84-096	40	0/65	5907558439267



x5 40 mm

Ref.	L [mm]	☞	EAN
84-095	40	0/100	5907558439250



x3 85 mm



Ref.	L [mm]	☞	EAN
84-097	85	0/50	5907558439274



Ref.	☞	EAN
84-092	8/40	5907558439151



Ref.	☞	EAN
84-094	0/50	5907558439175

Ref.	☞	EAN
84-093	0/100	5907558439168



Ref.	☞	EAN
84-098	0/100	5907558442526

Szczypce

Pliers set / Zange / Клеуци / Πλασσοκροχια, набор / Fogókészlet / Set cleste plat / Klešče / Kliešte, súprava / Klešče / Replės / Knaiblu komplekts / Nāpītsate komplekts / Щипцы / Kljiješta / Klesta set / Συλλογή πειναίων / Alicates / Pinza / Pinças / Pince / Tangen /



Ref.	☞	EAN
84-230	0/10	5907558424270

Szczypce do pierścieni osadczyc

Circlip pliers / Zange für Stellringe / Щипцы для стопорных колец / Щипцы для стопорных кільцев / Zegergrydú fogókészlet / Set cleste cu spirali / Klešče pro stavěcí kroužky / Segerky vonkajšie rovné / Klešče seger / Replės žiedams / Sprostgredzenu stangas / Vedrunāpītsad / Клеуци Зееар / Kružna Kljiješta / Kruzna klesta / Ασφαλοποιητές / Alicates para anillos de asiento / Set di pinze per anelli elastici / Pinças p. Anéis / Pince pour bagues de retenue / Tang voor dopringen

180 mm, zewnętrzne, proste / external, straight tip / щипцы для внешних/прямые
 170 mm, zewnętrzne, wygięte / external, bent tip / щипцы для внешних/загнутые
 180 mm, wewnętrzne, proste / internal, straight tip / щипцы для внутренних/прямые
 170 mm, wewnętrzne, wygięte / internal, bent tip / щипцы для внутренних/загнутые

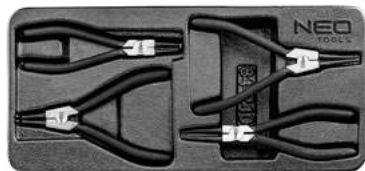

Ref.	☞	EAN
84-240	0/10	5907558424379

Wkrętaki

Screwdriver set / Schraubendreher / Отвертки / Відрізки, набір / Fogókészlet / Set šrubneljé / Šrubovavky / Súprava skrutkovačov / Garnitura izvijačev / Ацуктуйви / Skrivgriju kompleks / Kruvikeerajate komplekt / Отвертки комм. / Odvijaci / Odvijac set / Συλλογή από καταβίβια / Destornilladores / Set giravite piatti / Chaves de fenda / Tourmevis / Schroevendraaiers



3.0 x 75; 5.5 x 100; 5.5 x 200; 6.5 x 38; 6.5 x 125; 6.5 x 150; 8.0 x 150 mm

Ref.	📦	EAN
84-231	0/10	5907558424287



PH0 x 75 mm; PH1 x 75 mm; PH1 x 100 mm; PH2 x 38 mm; PH2 x 100 mm; PH2 x 150 mm; PH3 x 150 mm

Ref.	📦	EAN
84-232	0/10	5907558424294



- ⊕ PH00; PH0; PH1
- ⊕ P20; P21; P22
- ⊖ T10; T15; T20; T25
- ⊖ SL 2mm; SL 3mm

Ref.	📦	EAN
84-247	0/10	5907558424447

Klucze płasko-oczkowe

Ratchet wrench set / Maul-Ringschlüssel / Ключи комбинированные / Ключи рожково-накидні, набір / Csillagvilláskulcs készlet / Set chei cu clichet / Odkoploché klúče / Súprava OP račňových klúčov / Ključ villožasto-obročni / Raktas plokščias - kilpinis / Kombineto atslėgu kompleks / Pārkmutrīvātmete komplekt / Ключ звездозащелен / Set Ključevna / Ключ комбинирани / Συλλογή πολυγωνών κοσταςάς / Llaves combinadas (de estrella y a carraca abierta) / Set chiavi combinate / Chaves planas-de luneta / Clefs à fourche polygonales / Moersleutels



6x100; 7x110; 8x120; 9x130; 10x140; 11x150; 12x160; 13x170; 14x180; 15x190; 16x200; 17x210; 18x220; 19x230 mm

Ref.	📦	EAN
84-234	0/10	5907558424317



20x240; 21x250; 22x260; 24x280; 27x310; 29x340; 30x340; 32x360 mm

Ref.	📦	EAN
84-235	0/10	5907558424324

Klucze oczkowe odgięte

Offset ring spanner set / Ringschlüssel gebogen / Ключи накидные колеччатые / Ключи накидні коліччаті, набір / Csillagkulcs készlet / Set chei inelare de deviatje / Odkovny klíč vlnutý / Súprava očkových klúčov / Garnitura obráčnič ključev, upogjenih / Kilpinis, lenktų raktų kompleksas / Kombineto izliekto atslėgu kompleks / "Ofset" mutrivātmete komplekt / Ключ лупа / Ključ okasti / Ključ okasti set / Συλλογή κριπών πολυγωνών κλειδών με εκκλιμένη κεφαλή / Llaves de estrella, acodadas / Set chiavi inclinate ad anello / Chaves de luneta curvadas / Clefs polygonales contre-coudées / Gebogen ringsleutels



6x7; 8x9; 10x11; 12x13; 14x15; 16x17; 18x19; 20x22 mm

Ref.	📦	EAN
84-233	0/10	5907558424300

NEO
TOOLS

WYPOSAŻENIE WARSZTATU

WORKSHOP EQUIPMENT

МАСТЕРСКОЕ ОБОРУДОВАНИЕ

Klucze nasadowe

Drive socket set / Steckschlüssel / Набор сменных головок / Ключи торцевые / Dugókulcskészlet / Trusa tubulara / Nástrčné kľúče / Nástrčné kľúče / Nasadni ključji / Veržlerakcio antgali / Nomainámo galvu kompleks / Padgulnötmed / Сменная накладка на ключоце / Nasadni ključev / Ključevni patikaci / Set me karabidka / Llavas de vaso / Set busssole / Chaves articuladas / Clefs à douilles / Dopsleutel



4; 4,5; 5; 5,5; 6; 7; 8; 9; 10; 11; 12; 13; 14 mm

50; 100 mm 1/4"

148 mm

155 mm

Ref.	☞	EAN
84-237	0/10	5907558424348



8; 10; 11; 12; 13; 14; 15; 16; 17; 18; 19; 20; 21; 22; 24; 27; 30; 32; 34; 36 mm 1/2M x 3/8"

16; 21 mm 125; 250 mm

255 mm 1/4"

Ref.	☞	EAN
84-238	0/6	5907558424355



6; 7; 8; 9; 10; 11; 12; 13; 14; 15; 16; 17; 18; 19; 20; 21; 22; 24 mm

195 mm 3/8"

75 mm

Ref.	☞	EAN
84-239	0/10	5907558424362

Nasadki udarowe

Impact sockets / Schlagaufsätze / Nasadki udarowe / Patroni perforatorni / Gépi dugókulcs készlet / Brátáre percutante / Prikleporové nástavce / Prikleporové nástavce / Udarni nasadni ključji / Kalimo antgali / Triescienzuaji / Löökotsakud / Ударни наставкаи / Udarni nasadni nastavci / Udarne kapice / Удароцьк хроничної аналякціо / Llavas de vaso para atornilladores de impacto / Set busssole a percussione / Bocais de impacto / Douilles de choc / Slagtoppen



10; 12; 13; 14; 16; 17; 19; 21; 22; 24 mm

10; 12; 13; 14; 16; 17; 19; 21; 22; 24 mm

Ref.	☞	EAN
84-241	0/10	5907558424386

Nasadki sześciokątne długie

Hexagonal sockets / Sechskantaufsätze / Головки сменные шестигранные / Nasadki шестигранные / Dugókulcs hosszú készlet / Capete tubulare hexagonale / Šestihránné nástavce / Šestihránné nástavce / Šestkotni nasadni ključji / Šestiakotni antgali / Šestšúra notaináimás galvas / Kuuskantpadgulnöt / Шестостълни наставкаи / Šesterakotne kapice / Šestlougaoone nasadke / Каридкиа елјавна / Vasso hexagonales / Set busssole / Bocais hexagonais / Douilles à 6 pans / Zeskant dopper



8; 9; 10; 11; 12; 13; 14; 15; 16; 17; 18; 19; 20; 21 mm

Ref.	☞	EAN
84-243	0/10	5907558424309

Końcówki wkrętakowe

Driver bits / Einsätze für Schraubendreher / Nasadki / Нанонеченици вкрџкотои / Bitkészlet / Set biti / Šroubovákové nástavce / Skruvkovace nástavce / Nastavki za izvijače / Aisluktuno antgali / Škrúvgríeža uzgaji / Kruvikeeragaotsakud / Наикрџици за отџерта / Nastavci za odvijáč / Nastavci za odvijáč / Καταβίβουξ / Puntas destornilladoras / Set inserti / Ponteiras chave de fenda / Embouts de tournevis / Schraubendrehereinstückken



75 mm 1/2"; 3/8"
30 mm

● H4; H5; H6; H7; H8; H10; H12 ● H4; H5; H6; H7; H8; H10; H12

● M5; M6; M8; M10; M12 ● M5; M6; M8; M10; M12

★ T20; T25; T30; T40; T45; T50; T55 ★ T20; T25; T30; T40; T45; T50; T55

Ref.	☞	EAN
84-236	0/10	5907558424331

Zestaw narzędzi

Tools set / Werkzeugsatz / Набор инструментов / Набор инструмента / Szerszámkészlet / Set scule de grădini / Sada nářadí / Súprava nářadia / Garnitura orodja / Įrankių komplektas / Instrumentu komplektas / Tööriistakomplekt / Гадяе комплект / Set uređaja / Set alata / Συλλογή εργαλείων / Juego de herramientas / Set utensils / Kit de ferramentas / Jeu d'outils / Gereedschapsset

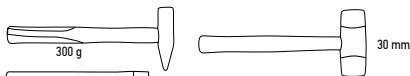

10; 13; 16 mm

Ref.	☞	EAN
84-242	0/10	5907558424393



Wkład profilowany

Profiled insert / Profileinsatz / Профилированный вставной элемент / Organoinsert / Tároló rekeszes tábla / Cartus profilat / Profilovaná vložka / Profilovaná vložka / Profilovaná vložka / Profiliuotas įdeklas / Profiliēts ieliekamais elements / Profilitud tihend / Профилтен элемент / Profilirani umetak / Profilirani umetak / Διάτρητο έμβλετο εξήριπια / Bandeja clasificadora perfilada / Vassoio / Cartuco perfilado / Profilirani umetak / Geprofileerde inzetdeel



550x386 mm

Ref.	☞	EAN
84-249	0/5	5907558424461



Pilniki

Files / Feilen / Напильники / Напильки / Reszelő készlet / Pile / Pilniki / Pilniki / Pile / Dildés / Viles / Viilid / Пилы / Turpije / Turpije / Лјец / Sapletes / Set di lime / Limas / Limes / Vijlen

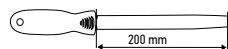

Ref.	☞	EAN
84-244	0/10	5907558424416



Listwy magnetyczne

Magnetic tool holders / Magnetsche Werkzeughalter / Держатели магнитных инструментов / Магнитни тримачи инструмента / Magnetses szerszámtartók / Suporturi de scule magnetice / Magnetické držáky nástrojů / Magnetské držáky nástrojov / Magneta držala za orodja / Magnetniq įrankių laikikliai / Magnētisko instrumentu turētāji / Magnetliste tööriistade hoidjad / Магнитни държачи за инструменти / Magnetski držači alata / Magneti držači alata / Μαγνητικά εργαλεία στηρίξης / Porta-herramientas magnéticas / Porta-utensili magnetics / Porta-ferramentas magnéticas / Porte-outils magnétiques / Magnetsche gereedschapshouders



Ref.	☞	EAN
84-144	6/12	5907558449006

Narzynki i gwintowniki

Tap and die set / Schneideisen und Gewindebohrer / Плашки и метчики / Позначники и плашки, набор / Menetkészítő készlet / Set scule țiere filet interior și exterior / Závıtnice a závıtnıky / Súprava závıtnıkov / Garnitura vreznikov in nareznikov navoja / Sriegpovės ir sriegikliai / Vırtņgrežu komplekts / Kraani ja valvutomi komplekt / Метчици и плашки / Nareznice i ureznice set / Set ureznika i nareznika / Ελικοκάρτες και καλοαύρα / Cojnetes y machos de roscar, juego / Set di filiere a maschi / Cassonetes e roscas / Filières et tarauds / Snijsplaat en schroefdraad snijtoestel



M3; M4; M5; M6; M8; M10; M12 - 25 x 9 mm

Ref.	☞	EAN
84-246	0/10	5907558424430



Szafka serwisowa 6 szuflad (nadstawka)

Service cabinet 6 drawers (extension) / Serviceschrank 6 Schubladen (Erweiterung) / Шкаф для обслуживания 6 ящиков (верхний блок) / Службозна шафа 6 оцунувних ящїкїв / Szervizszekrény 6 fiókkal (felső egység) / Dulap de service 6 sertare (extensie) / Servisni skřınka 6 zásuvek (prodloužení) / Servisná skřinka 6 zásuvek (výsuv) / Servisna omara 6 predalov (podaljšek) / Aptarnavimo spinta 6 stalčiai (praiglinimas) / Arkaplošanas skapis 6 atvilktnes (pagarinājums) / Teenninduskapp 6 sahtlit (pikendus) / Сервисен шкаф 6 ченмежджета (удължение) / Servisni armar 6 ladica (produžetak) / Сервисни ормар 6 фиона (продужетак) / Σερβις 6 αυρτιρα (επέκταση) / Armario de servicio 6 cajones (extensión) / Mobile di servizio 6 cassetti (allungaa) / Gabinet de servicio 6 gavetas (extensão) / Armoire de service 6 tiroirs (extension) / Servicekast 6 lades (uitbouw)



Ref.	☞	EAN
84-219	1/1	5907558446142

NEO
TOOLS

WYPOSAŻENIE WARSZTATU

WORKSHOP EQUIPMENT

МАСТЕРСКОЕ ОБОРУДОВАНИЕ

Modułowa szafka narzędziowa

Tool cabinet / Werkzeugschrank / Шкафчик для инструментов / Шкафа инструментальна / Rakásoltató műhelykocsi / Dulap pentru scule / Skříňka na nářadí / Skrinka na náradie / Omacica za orodje / Irankiú spintélé / Instrumentu skapis / Tööriistakapp / Шкафچه за инструментами / Ormar za alate / Ormarici za alatke / Noulanaki gia eyrakia / Armario de almacenaje para herramientas / Carrello porta utensili / Estante p. Ferramentas / Rmoire à outils / Gereedschapskast

Uchwyty boczne ułatwiające przenoszenie
Side handles for easier carrying
Боковые ручки, облегчающие переноску



Łączenie modułowe - możliwość konfiguracji modułów według własnych preferencji
Modular linking - possibility to configure modules in accordance with one's preferences
Модульная конструкция - возможность конфигурации модулей по собственному усмотрению



Blokada szuflad
Drawer lock
Блокировка выдвижных ящиков



Miejsce na kłódkę - dodatkowe bezpieczeństwo
Additional safety - place for a padlock
Дополнительная безопасность - скобы для навесного замка



Demontowalne kółka pasujące do każdego modułu
Detachable wheels match with all modules
Съемные колеса подходят к каждому модулю



16 pojemników w zestawie
16 containers included
В наборе 16 контейнера



Adaptowalne wnętrze
Arrangeable inside
Конфигурируемое внутреннее пространство



Hamulec kół
Wheels brake
Тормоз колеспространство



Ref.	info		EAN
84-226	59,9 x 37,8 x 59,9 cm	0/1	5907558425512

Uchwyty boczne ułatwiające przenoszenie
Side handles for easier carrying
Боковые ручки, облегчающие переноску



Miejsce na kłódkę - dodatkowe bezpieczeństwo
Additional safety - place for a padlock
Дополнительная безопасность - скобы для навесного замка



Blokada szuflad
Drawer lock
Блокировка выдвижных ящиков



Łączenie modułowe - możliwość konfiguracji modułów według własnych preferencji
Modular linking - possibility to configure modules in accordance with one's preferences
Модульная конструкция - возможность конфигурации модулей по собственному усмотрению



Ref.	info		EAN
84-227	3 szuflady / 3 drawers	0/2	5907558425529
84-228	2 szuflady / 2 drawers	0/2	5907558425536

System modułowy I

Modular system / Modulares System / Модульная система / Модульна система / Moduláris rendszer / Sistem modular / Modulární systém / Modulový systém / Modulami sistem / Moduline sistema / Modulu sistema / Modulaarne süsteem / Модуляна система / Modulami sustav / Модуларни систем / Арборат оуства / Sistema modular / Sistema modulare / Sistema modular / Système modulaire / Modulair systeem



Lita uszczelka w pokrywie - wodoodporna
Waterproof
водонепроницаемый



Szyna na ścisaki
Rail for clamps
Рельс для зажимов



Duże gumowane koła
Large rubber wheels
Большие резиновые колеса



Organizery w pokrywie
Organisers on lid
Организаторы в обложке



Przegrody z gumowymi szelkami
Partitions with rubber braces
Перегородки с резиновыми скобками



Możliwość stania na pokrywie do 120kg
Ability to stand on the lid up to 120kg
Возможность стоять на крышке до 120 кг



Prowadnica do cięcia
Cutting guide
Резущий инструмент



Teleskopowy uchwyt
Telescopic handle
Телескопическая ручка



Mocne zapiecia
Durable latches
Крепкие крепления



System modułowy
Modular system
модулярный систем



Duża pojemność/nośność 50kg
Large capacity up to 50kg
Большая вместимость до 50 кг



Przednie koła w pełni skretne z hamulcem
Front wheels fully swivel with brakes
Вращающиеся передние колеса с тормозами



Ref.	☞	EAN
84-259	0/1	5907558431674



Ref.	☞	EAN
84-266	0/1	5907558433968



Ref.	☞	EAN
84-267	0/1	5907558433975



Ref.	☞	EAN
84-286	1/1	5907558446470
84-287	1/120	5907558446487



Ref.	☞	EAN
84-269	0/1	5907558443972



Ref.	☞	EAN
84-256	0/1	5907558431643
84-257	0/1	5907558431650

NEO
TOOLS

WYPOSAŻENIE WARSZTATU

WORKSHOP EQUIPMENT

МАСТЕРСКОЕ ОБОРУДОВАНИЕ

System modułowy I

Modular system / Modulares System / Модульная система / Модульна система / Moduláris rendszer / Sistem modular / Modulární systém / Modulový systém / Modularni sistem / Modulné sistema / Moduluji sistema / Modulaarne süsteem / Модульна система / Modularni sustav / Модуларни систем / Арђивот алатица / Sistema modular / Sistema modulare / Sistema modular / Système modulaire / Modulair systeem



Ref.	📦	EAN
84-276	0/1	5907558443608



Ref.	📦	EAN
84-277	0/1	5907558443615

System modułowy II

Modular system / Modulares System / Модульная система / Модульна система / Moduláris rendszer / Sistem modular / Modulární systém / Modulový systém / Modularni sistem / Modulné sistema / Moduluji sistema / Modulaarne süsteem / Модульна система / Modularni sustav / Модуларни систем / Арђивот алатица / Sistema modular / Sistema modulare / Sistema modular / Système modulaire / Modulair systeem



Ref.	📦	EAN
84-066	1/1	5907558450118



Ref.	📦	EAN
84-062	0/1	5907558450071



Ref.	📦	EAN
84-061	1/1	5907558450064



Ref.	📦	EAN
84-060	1/1	5907558450057



Ref.	📦	EAN
84-063	1/1	5907558450088
84-064	1/1	5907558450095



Ref.	📦	EAN
84-065	1/1	5907558450101



Plecak monterski

Tool backpack / Monteurrucksack / Рюкзак монтерский / Рюкзак монтерський / Szerszámás hátizsák / Rucsac pentru mecanic / Batoh na náradie / Plecniak na náradie / Nahrtnik za orodje / Montuotojo irankių kuprinė / Instrumentu mugursoma / Tööriistade seljakott / Монтърска раница / Rusak za montere / Monterski ranac / Σάκος εργαλείων / Mochila de montador / Zaino porta utensili / Mochila para ferramentas / Sac à dos porte-outils / Monteur rugzak



Ref.	📦	EAN
84-304	0/6	5907558425833



Ref.	📦	EAN
84-307	0/10	5907558427721

Plecak monterski na kotach

Tool backpack with wheels / Monteurrucksack mit Rädern / Рюкзак монтерский на колесках / Рюкзак монтерський на коліщатах / Szerszámás hátizsák / Rucsac pe roti pentru mecanic / Batoh na náradí na kolečkách / Plecniak na náradie na kolieskach / Nahrtnik za orodje na kolesih / Montuotojo irankių kuprinė su ratukais / Instrumentu mugursoma uz riteņiem / Tööriistade seljakott, ratastege / Монтърска раница на колела / Rusak za montere s kotačima / Monterski ranac sa točkicama / Σάκος εργαλείων με ρόδες / Mochila de montador sobre ruedas / Trolley/zaino in tela / Mochila para ferramentas com rodas / Sac à dos porte-outils à roulettes / Monteur rugzak op wielen



Ref.	📦	EAN
84-303	0/2	5907558425826

Torba monterska

Tool bag / Monteurtasche / Сумка монтерская / Торба інструментальна / Szerszámtáska fém fogantyúval / Geanta scule / Monterská brašna / Taška monterska kožená / Torba za orodje / Monterio krepšys / Instrumentu soma / Tööriistakott / Футр за инструменту / Torba za alat / Torba za alat / Σάκος για εργαλεία / Bolsa para herramientas / Borsa per meccanico / Saco p. montagem / Sac de monter / Montagetas



Ref.	📦	EAN
84-301	0/2	5907558425802



Ref.	📦	EAN
84-308	0/4	5907558427745

Torba monterska na kotach

Tool bag with wheels / Monteurtasche / Монтерская сумка на колесках / Торба монтерська на коліщатах / Szerszámtáska / Geantă pe roti pentru mecanic / Taška na náradí na kolečkách / Taška na náradie na kolieskach / Torba za orodje na kolesih / Montuotojo krepšys su ratukais / Instrumentu soma uz riteņiem / Tööriistakott, ratastege / Монтърска торба на колела / Torba za montere s kotačima / Monterska torba sa točkicama / Távta εργαλείων με ρόδες / Bolsa de montador sobre ruedas / Trolley in tela / Bolsa para ferramentas com rodas / Sac porte-outils à roulettes / Monteurstas op wielen



Ref.	📦	EAN
84-302	0/2	5907558425819

Stołek z torbą monterską

Chair with tool bag / Sitz mit Monteurtasche / Табурет складной с монтерской сумкой / Столик із монтерською торбою / Szerszámátáska székek funkcióval / Scaunuş cu geantă pentru mecanic / Skládací židle s taškou na nářadí / Stolik s taškou na nářadí / Mizica s torbo za orodje / Staliukas su montuotojo krepšiu / Tabureta ar instrumentu somu / Toöriistakotiga laud / Табуретка с монтерской торбой / Stolica s torbom za montere / Stolica s torbom za monterskom torbom / Πτυσσόμενο οκαζιόκι με τσάντα εργαλείων / Silla con bolsa de montador / Seggiolino pieghevole con borsa / Banco con bolsa para ferramentas / Sac à outils avec siège pliant / Kruk met monteurtas



Wzmocniony, wytrzymały materiał - Poliester
Strengthened, durable fabric - polyester
Усиленный, прочный материал - Полиэстер



Trwały, wzmocniony, podwójny zamek główny
Strengthened, durable double main zipper
Надежная, крепкая, двойная основная застежка-молния



Regulowany pasek na ramię
Adjustable arm belt
Регулируемый плечевой ремень



Uchwyt do przenoszenia
Carrying handle
Ручка для переноски



Odpinana torba
Fastened bag
Отстегивающаяся сумка



6 kieszeni zewnętrznych
6 inside pockets
6 наружных карманов



Podwójny, wzmocniony szef zamka
Reinforced double seam zipper
Двойной, усиленный шов застежки-молнии

Ref.	📦	EAN
84-306	0/10	5907558425796

Torba narzędziowa

Tool bag / Werkzeugtasche / Сумка для инструментов / Торба інструментальна / Szerszámátáska / Geantă de scule / Brašna na nářadí / Taška na nářadí / Torba za orodje / Įrankių krepšys / Instrumentu soma / Toöriistakoti / Табуретка за инструменти / Torba za alate / Kesa za alat / Тсάντα εργαλείων / Bolsa portaherramientas / Borsa porta utensili / Saco para ferramentas / Sac à outils / Gereedschapstas

Wykonana z mocnego tkanego nylonu 600x600 Denier
Duża pojemność oraz łatwy dostęp do zawartości
Solidna, gumowa rączka, dodatkowe pasy naramienne oraz przykrycie zapinane na rzep
Produced from strong woven nylon 600x600 Denier
High capacity and easy access to contents
Robust rubber handle, additional arm belt and cover with Velcro attachments
Изготовлена из прочной нейлоновой ткани 600x600 Denier
Вместительная с простым доступом к содержимому
Прочная резиновая ручка, плечевой ремень и крышка на липучке



Wykonana z mocnego tkanego nylonu 600x600 Denier
Wodoodporny materiał
Mocne, wodoodporne dno wykonane z tworzywa
Otwarta torba stojąca – zapewnia łatwy dostęp do narzędzi
Produced from strong woven nylon 600x600 Denier
Waterproof material
Robust and waterproof bottom made of plastic
Open standing bag – ensures easy access to tools
Изготовлена из прочной нейлоновой ткани 600x600 Denier
Водонепроницаемый материал
Прочное жесткое дно из водостойкой пластмассы
Может стоять в открытом состоянии – быстрый доступ к инструменту



Ref.	📦	EAN
84-300	0/4	5907558417258



Ref.	📦	EAN
84-305	0/6	5907558417265

Skrzynka narzędziowa

Tool box / Werkzeugkasten / Ящик для инструмента / Суняня инструментальна / Szerszámáldá / Cutie scule / Náradová skříňka / Basa na náradie / Škatla za orodje / Įrankių dėžė / Instrumentu koferis / Tööriistakast / Купфар за инструменти / Kutija za alat / Kutija za alat / Еуралеюйжик / Caja de herramientas / Valigetta electricista modulare / Caixa p. ferramentas / Caisse à outils / Gereedschapskist



Trwała i solidna obudowa
Sturdy and durable casing
Прочная и добротная конструкция



Dodatkowy wycienny organizer
Additional removable organiser
Дополнительный съемный органайзер



Aluminiowe zatrzaski
Aluminium clamps
Алюминиевые защелки



Ergonomiczny uchwyt
Ergonomic handle
Эргономичная рукоятка



Pojemne organizery
Spacious organizers
Вместительные организеры



Stalowe trzpienie zawiasów
Steel pins of hinges
Стальные стержни петель



Adaptowalne wnętrze
Arrangeable inside
Конфигурируемое внутреннее пространство



Ref.	Info	EAN
84-117	0/4	5907558425543

Organizer

Organizer / Organizer / Организаер / Органайзер / Szortimenter / Organizer / Organizer / Organizer plast. na spoj. materiál / Škatla za orodje / Systeineris / Sirkumkaste / Säilituskast / Organizaer / Kutija za alat / Kutija za alat / Organizer / Organizador / Organiser / Agenda / Organiseur / Organizer



12 wymiowych pojemników
12 removable containers
12 съемные контейнеры



Antywstrząsowe narożniki
Anti-shake corners
Активационные углы



Poliwęglanowa pokrywa
Polycarbonate cover
Поликарбонатная крышка



Aluminiowe zapiecie
Aluminium clasp
Алюминиевая застёжка



8 wymiowych pojemników
8 removable containers
8 съемные контейнеры

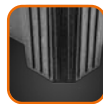

Antywstrząsowe narożniki
Anti-shake corners
Активационные углы



Poliwęglanowa pokrywa
Polycarbonate cover
Поликарбонатная крышка



Aluminiowe zapiecie
Aluminium clasp
Алюминиевая застёжка



Regulowane przegrody
Adjustable dividers
Регулируемые отсеки



Ref.	Info	Info	EAN
84-130	40 x 40 x 12 cm	0/1	5907558431216



Ref.	Info	Info	EAN
84-131	39 x 60 x 11 cm	0/1	5907558431223

NEO
TOOLS

WYPOSAŻENIE WARSZTATU

WORKSHOP EQUIPMENT

МАСТЕРСКОЕ ОБОРУДОВАНИЕ

Warsztat mobilny

Mobile workshop / Werkzeugkasten / Мобильная мастерская / Сиринья инструментальна / Szerszámkocsi / Cutie scule / Nářadová skříňka / Basa na náradie / Škatla za orodje / Įrankių dėžė / Instrumentu koferis / Tööriistakast / Нуфар за инструменти / Kutija za alat / Kutija za alat / Ералейбѣжк / Caja de herramientas / Carrello porta utensili / Caixa p. ferramentas / Caisse à outils / Gereedschapskist

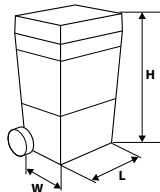

4 x organizer w pokrywie
4 organizers in the cover
4 x оргайзера в крышке



wzmocnione uchwyty
reinforced handles
усиленные ручки



4 zamknięte pojemniki
4 closing containers
4 закрывающихся контейнера

solidny system jezdny z metalową osią i kołami
zabezpieczonymi warstwą gumy pozwala na prace
nawet w ekstremalnych warunkach
sturdy wheels system with metal axis and rubber
layer protecting the wheels
прочные колеса с резиновым покрытием,
посаженные на металлическую ось



modułowa budowa (pojemna skrzynka + moduł 4 x Ergobox
2 Plus + pojemnik na elektronarzędzia) – pozwala na
transport zróżnicowanych materiałów
modular design (spacious box + 4 x Ergobox 2 Plus module
+ container for power tools)
модульная конструкция (вместительный ящик + модуль
4 x Ergobox 2 Plus + контейнер для электроинструмента)

Ref.	L [mm]	W [mm]	H [mm]	☐	EAN
84-115	495	360	710	0/1	5907558421682

Skrzynka narzędziowa na kołach

Tool box with wheels / Werkzeugkasten / Ящик для инструмента с колесами / Сиринья инструментальна / Szerszámkocsi / Cutie scule / Nářadová skříňka / Basa na náradie / Škatla za orodje / Įrankių dėžė / Instrumentu koferis / Tööriistakast / Нуфар за инструменти / Kutija za alat / Kutija za alat / Ералейбѣжк / Caja de herramientas / Carrello porta utensili / Caixa p. ferramentas / Caisse à outils / Gereedschapskist

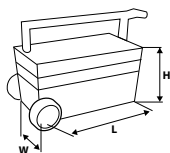

duży organizer z regulowanymi przegrodami
umieszczonymi na pokrywie skrzynki
large organizer with adjustable compartments
большой оргайзер с регулируемыми
перегородками

alumiuniowa teleskopowa rączka
aluminium telescopic handle
алюминиевая телескопическая ручка



metalowe zapięcia pozwalają na bezpieczny transport
ciężkiego ładunku
metal clasps allow for safe transport of heavy loads
металлические защелки обеспечивают безопасную
транспортировку тяжелого груза



solidny system jezdny z kołami
zabezpieczonymi warstwą gumy
sturdy wheels system with rubber layer
protecting the wheels
прочные колеса с резиновым
покрытием



mobilna skrzynka narzędziowa o dużej ładowności
mobile tool box with high capacity
мобильный ящик для инструмента большой
вместимости

Ref.	L [mm]	W [mm]	H [mm]	☐	EAN
84-116	680	400	355	0/1	5907558421699

Skrzynka narzędziowa

Tool box / Werkzeugkasten / Ящик для инструментов / Сунья инструментальна / Szerszámtároló / Cutie scule / Náradová skříňka / Basa na náradie / Škatla za orodje / Įrankių dėžė / Instrumentu koferis / Tööriistakast / Нуфак за инструменти / Kutija za alat / Еуақабәтқә / Caja de herramientas / Cassetta porta utensili / Estante p. Ferramentas / Armoire à outils / Gereedschapskist

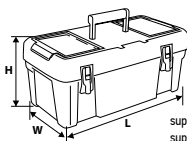

super wytrzymałe, pojemne poliwęglanowe pokrywy organizerów
super-strong polycarbonate covers of the organizers
очень прочные крышки органайзеров из поликарбоната



możliwość zapięcia na kłódkę
possible to lock with a padlock
можно закрыть на навесной замок



dwupoziomowa, rozkładana tacka
two layers folding tray
двухуровневый, раскладной лоток

solidne aluminiowe zapięcia
sturdy aluminium clamps
прочные алюминиевые защелки



możliwość oparcia górnej pokrywy na uchwycie
upper cover can rest on the handle
можно опереть верхнюю крышку о ручку



Ref.	L [mm]	W [mm]	H [mm]	📦	EAN
84-102	460	240	255	0/1	5907558409574
84-105	545	280	270	0/1	5907558408683

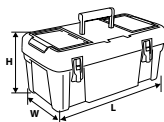

metalowe trzpienia w zawiasach,
zwiększające żywotność skrzynki
metal pins in hinges improve tool box lifetime
петли на металлических стержнях
увеличивают срок службы ящика



pojemne organizery z super
wytrzymałymi poliwęglanowymi
pokrywkami
super-strong polycarbonate covers of the organizers
очень прочные крышки органайзеров из поликарбоната



plastikowe narożniki powleczone gumą
zabezpieczają skrzynkę przed uszkodzeniem oraz
przesuwaniem się
plastic and rubber coated corners protect the tool box
from damages and prevent shifting
пластмассовые уголки с резиновым покрытием
предохраняют ящик от повреждений и
предотвращают его перемещение



możliwość zapięcia na kłódkę
possible to lock with a padlock
можно закрыть на навесной замок

Ref.	L [mm]	W [mm]	H [mm]	📦	EAN
84-114	495	360	710	0/1	5907558439182

NEO
TOOLS

WYPOSAŻENIE WARSZTATU

WORKSHOP EQUIPMENT

МАСТЕРСКОЕ ОБОРУДОВАНИЕ

Skrzynka narzędziowa

Tool box / Werkzeugkasten / Ящик для инструмента / Сирня инструментална / Szerszámáda / Cutie scule / Nářadová skříňka / Baso na náradie / Škatla za orodje / Irankiu dėžė / Instrumentu koferis / Tööriistakast / Нудар за инструменту / Kutija za alat / Kutija za alat / Εργαλειοθήκη / Caja de herramientas / Cassetta portautensili / Estante p. Ferramentas / Armoire à outils / Gereedschapskast



skrzynka po otwarciu rozsuwa się na dwie strony ułatwiając dostęp do narzędzi
when opened, the case draws to two sides for easy access to tools within it
при открытии ящик раздвигается в стороны, облегчая доступ к инструментам

Ref.	L [mm]	W [mm]	H [mm]	m [kg]	☞	EAN
84-100	460	220	210	4,3	1/1	5907558409437
84-101	550	220	210	5	1/1	5907558409444

Organizer

Organizer / Organizer / Organizaşep / Organizaşep / Csavartartó szortimenter / Organizer / Organizér / Organizér / Cutie na spoj. materiál / Škatla za orodje / Systemeris / Sirkumkaste / Säilituskast / Organizaşep / Kutija za alat / Kutija za alat / Organizer / Organizador / Organiser / Agenda / Organiseur / Organizer

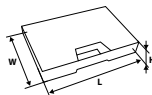

polipropylenowa, przezroczysta pokrywa
możliwość samodzielnej adaptacji przegródek
polypropylene, transparent cover
possibility to adapt partitions individually
полипропиленовая прозрачная крышка
возможность самостоятельной переустановки перегородок



Ref.	L [mm]	W [mm]	H [mm]	☞	EAN
84-118	390	290	65	0/1	5907558439229
84-119	490	390	65	0/1	5907558439236

Perforacja narzędziowa

Tool wall / Werkzeuglochung / Панель перфорированная для инструментов / Панель инструментална / Szerszámofal / Suport perete pentru unelte / Perforace pro uchycení držáků nářadí / Panel na náradie / Stenski regal / Sienelė irankiams / Instrumentu plaukts / Tööriistalaus / Перфорация на инструменту / Perforirani organizer za alate / Polica za alat / Тоїс за ерґаїє / Tablero organizador para herramientas / Perforazione per attrezzi / Perforação de ferramentas / Plaques perforées pour outils / Gereedschapswand

Kompatybilne z hakami NEO
Compatible with NEO hooks
Совместим с крючками NEO

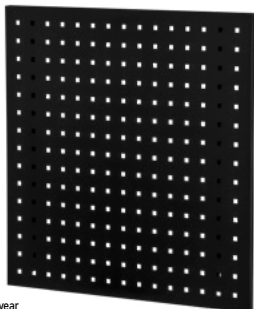

Dostępne w drugiej połowie 2021 roku
Available in the second half of the 2021 year
Доступен во второй половине 2021 года

Ref.	H [mm]	W [mm]	D [mm]	☞	EAN
84-500	600	600	20	0/1	5907558454253

Kompatybilne z hakami NEO
Compatible with NEO hooks
Совместим с крючками NEO

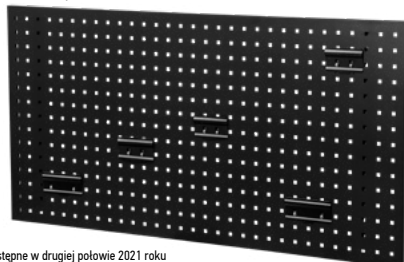

Dostępne w drugiej połowie 2021 roku
Available in the second half of the 2021 year
Доступен во второй половине 2021 года

Ref.	H [mm]	W [mm]	D [mm]	☞	EAN
84-501	600	1200	20	0/1	5907558454260

Hak na pojemnik

Hooks / Hacken / Крюку / Гану / Horgok / Cârłige / Hákы / Skoby / Kljake / Kabliari / Āķi / Haagid / Нука / Kuke / Kuke / Ганґи / Ganchos / Ganci / Anzõis / Crochets / Haken



Dostępne w drugiej połowie 2021 roku
Available in the second half of the 2021 year
Доступен во второй половине 2021 года

Ref.	☞	EAN
84-502	250/250	5907558454277



Dostępne w drugiej połowie 2021 roku
Available in the second half of the 2021 year
Доступен во второй половине 2021 года

Ref.	☞	EAN
84-503	250/250	5907558454284

Wózek transportowy

Multipurpose trolley / Transportwagen / Тележка грузозовая / Візок транспортувальний / Molnárkocsi / Cărucior de transport / Převážní vozík / Prepravný vozík / Transportni vozíček / Maišelės transportavimui / Ratiņi / Veokāru / Транспортна калница / Transportna kolica / Transportna kolica / Καρότσια μεταφορής / Carretilla de transporte / Carrello di trasporto / Carrinho de transporte / Chariot de manutention / Transportwagen



Możliwość zabezpieczenia towaru linką
The possibility of securing the goods with bungee cord

Возможность крепления груза при помощи шнура



Kompaktowy - łatwe przechowywanie
Compact - easy storage

Компактний - легкий в храненні

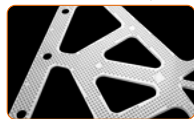

Wytrzymała aluminiowa platforma
Durable aluminum toe plate

Прочная алюминиевая платформа



Ref.	☞	EAN
84-400	0/6	5907558431605



Ref.	☞	EAN
84-402	0/1	5907558431612



Ref.	☞	EAN
84-403	0/1	5907558431629



Ref.	☞	EAN
84-401	0/1	5907558431605

NEO
TOOLS

WYPOSAŻENIE WARSZTADU

WORKSHOP EQUIPMENT

МАСТЕРСКОЕ ОБОРУДОВАНИЕ

Klucz pneumatyczny udarowy

Pneumatic impact wrench / Pressluftschlagschlüssel / Ключ пневматический ударный / Ключ пневматичний ударний / Pneumatikus ütvecsavarozó / cheie pneumatică de lovit / Pneumatický nárazový klíč / Pneumatická rázová uťahovačka / Pnevmatiski udarni vijac / Pneumatikis, smūginis veržiaraktis / Pneumatiskā siliena pistole / Pneumatiline löök-mutrivõti / Гаїквоетр пневматичен / Pnevmatiski ključ udarni / Pnevmatiski ključ / Цупці аэроэ апастрэўнэ / Llave de impacto neumática / Chiave pneumatica a percussione / Chave pneumática de impacto / Clef pneumatique à chocs / Pneumatisch slagstelsel



Ref.	Info	⊞	EAN
14-002	1/2", 1300 Nm, 6.3-7.0 bar, 128 l/min., 7000 min ⁻¹ (+/- 10%), Twin Hammer, 2.2 kg	1/6	5907558442533



Ref.	Info	⊞	EAN
14-004	1/2", 680Nm, 6.3 - 7 bar, 113 l/min., 10 000 min ⁻¹ (+/- 10%), Twin Hammer, 1.5 kg	1/6	5907558442540



Ref.	Info	⊞	EAN
14-006	1/2", 680Nm, 6.3 - 7 bar, 113 l/min., 10 000 min ⁻¹ (+/- 10%), Jumbo, 1.46 kg	1/6	5907558442557



Ref.	Info	⊞	EAN
14-008	3/4", 2000Nm, 6.3 - 7 bar, 227 l/min., 3 500 min ⁻¹ (+/- 10%), (Twin Hammers), 3.9 kg	1/4	5907558442564



Ref.	Info	⊞	EAN
14-500	1/2", 680Nm, 6.3 bar, 113 l/min., 7500 min ⁻¹ (+/- 10%), 2.7 kg	1/10	5907558444834



Ref.	Info	⊞	EAN
14-502	1/2", 314Nm, 6 - 8 bar, 230 l/min., 7000 min ⁻¹ (+/- 10%), HEX: 9, 10, 11, 13, 14, 17, 19, 22, 24, 27 mm, 4.45 kg	1/5	5907558444841

Klucz pneumatyczny udarowy

Pneumatic impact wrench / Pressluftschlagschlüssel / Ключ пневматический ударный / Ключ пневматичний ударний / Pneumatikus ütveszvarozó / cheie pneumatică de lovit / Pneumatický nárazový klíč / Pneumatická rázová utahovačka / Pnevmatski udarni vijak / Pnevmatis, smāginis veržlārarkts / Pnevmatskā sītiņa pistole / Pnevmatiline lōōk-mūtrivāti / Гаўковерт пневматычн / Pnevmatski Ključ udarni / Pnevmatski ključ / Στριπi αέρος αναστρέφμενο / Llave de impacto neumática / Chiave pneumatica a percussione / Chiave pneumatica de impacto / Clef pneumatique à chocs / Pnevmatsch slagsleutel



Ref.	Info	⚙	EAN
14-010	1, 3800Nm, 6.3 - 7 bar, 232 l/min., 2 800 min ⁻¹ (+/- 10%), PINLESS, 18.0 kg	1/1	5907558442571

Szliferka prosta pneumatyczna

Pneumatic straight grinder / Schleifmaschine gerade pneumatisch / Прямой пневматический шлифовальный аппарат / Шліфмашина пряма пневматична / Pneumatikus egyenes csiszológép / Polizor simplu, pneumatic / Pmānā pnevmaticā bruska / Pnevmatickā jednoduchā brūska / Pnevmatski premi bruslīnik / Pnevmatis, tiesinis šļīfuoklis / Pnevmatska taisna slīpmašīna / Pnevmatiline lihtlīhvija / Обкнжен пневматычн шлайф / Pnevmatska jednostavna brusilica / Pnevmatska prosta obična brusilica / Ευθεία λειαντήρας αέρος / Amoladora neumática recta / Smerigliatrice pneumatica dritta / Disco de limar reto pneumático / Meuleuse droite pneumatique / Pnevmatsche rechte schuurmachine



Ref.	Info	⚙	EAN
14-014	1/4"/1/8, 25 000 min ⁻¹ , 6.3 - 7 bar, 85 l/min., 0.32 kg	1/20	5907558442595

Szliferka oscylacyjna pneumatyczna

Pneumatic finishing sander / Vibrationsschleifer pneumatisch / Вибрационный пневматический шлифовальный аппарат / Шліфмашина оциляційна пневматична / Pneumatikus vibrációs csiszológép / Polizor oscilatoriu, pneumatic / Oscilační pnevmatická bruska / Pnevmatickā vobračnā brūska / Pnevmatski vibrācijski bruslīnik / Vibrācinis, pnevmatis šļīfuoklis / Pnevmatska oscilācijas slīpmašīna / Pnevmatiline taldlīhvija / Оциляторн пневматычн шлайф / Pnevmatska vibrācijaska brusilica / Pnevmatska oscilatorna brusilica / Πολυκίτρο τρίβελο αέρος / Lijadora neumática orbital / Levigatrice a delta pneumatica / Disco de limar oscilante pneumático / Meuleuse oscillatoire pneumatique / Pnevmatsche oscillatie schuurmachine /



Ref.	Info	⚙	EAN
14-018	89x165 mm, 9 000 min ⁻¹ , 6.3 - 7 bar, 128 l/min., 1.78 kg	1/10	5907558442618

Klucz kątowy pneumatyczny

Pneumatic angle wrench / Winkelschlüssel pneumatisch / Ключ угловой пневматический / Мутроверт кутювий пневматычнй / Pneumatikus racsnis kulcs / Cheie unghiulară, pneumatică / Угловй клíč пневматычкй / Pnevmatický uhlový klíč / Pnevmatska raglja / Pnevmatis kampinis raktas / Pnevmatskā leņķu atslēga / Pnevmatiline nurkvāti / Ёлов пневматычн ключ / Pnevmatski kutni ključ / Pnevmatski ugaoni ključ / Κλειδί γωνιακό αέρος / Llave articulada neumática / Chiave pneumatica angolare / Chiave de canto pneumático / Clef d'angle pneumatique / Pnevmatsch haaksleutel



Ref.	Info	⚙	EAN
14-012	1/2", 88Nm, 6.3 - 7 bar, 113 l/min., 180 min ⁻¹ (+/- 10%), 1.17 kg	1/20	5907558442588

Szliferka pneumatyczna kątowna

Pneumatic angle grinder / Pressluftwinkelschleifer / Машина шлифовальная угловая пневматическая / Шліфмашина пневматична наріжна / Pneumatikus csiszoló / Mašīnā pnevmaticā de slefuit sub unghi / Pnevmaticā bruska ūhlovā / Brūska pnev. uhlovā / Kotni pnevmatski bruslīnik / Pnevmatis kampinis šļīfuoklis / Pnevmatskā leņķa slīpmašīna / Pnevmatiline nurklīhvismāsin / Ёлошлайф пневматычн / Pnevmatska kutna brusilica / Pnevmatska brusilica / Γωνιακό τρίχο αέρος / Amoladora neumática angular / Retificatrice pneumatica angolare / Disco de limar p. cantos pneumático / Meuleuse pneumatique d'angle / Pnevmatsche versteckschuurmachine



Ref.	Info	⚙	EAN
14-016	6 mm/3mm, 20 000 min ⁻¹ , 6.3 - 7.0 bar, 85 l/min., 0.46 kg	1/20	5907558442601



Ref.	Info	⚙	EAN
14-508	125 mm, 10 000 min ⁻¹ , 6 - 8 bar, 170 l/min., 1.9 kg	1/20	5907558444858

Nasadka udarowa

Impact socket / Schlagaufsatz / Насадка ударная / Патрон перфораторный / Gépi dugókulcs / Βράχταρ сu pερcutιe / Příkladový nástavec / Příkladový nástavec / Udarni nasadni ključ / Antgalis kalimuo / Triecienpuzgalis / Löökötsakud / Ударни наставка / Ударни насадки / Ударна капича / Υπόδοxής κρουσικου ανταλλακτικου / Llaves de vaso para atornilladores de impacto / Bussola esagonale / Bocal de impacto / Douille à choc / Slagdot



CrMo
steel



CrMo
steel



Ref.	W[mm]	L[mm]	⊖	EAN
12-210	10	38	20/200	5907558423808
12-211	11	38	20/200	5907558423815
12-212	12	38	20/200	5907558423822
12-213	13	38	20/200	5907558423839
12-214	14	38	20/200	5907558423846
12-215	15	38	20/200	5907558423853
12-216	16	38	20/200	5907558423860
12-217	17	38	20/200	5907558423877
12-219	19	38	20/200	5907558423884
12-221	21	38	20/200	5907558423891
12-222	22	38	20/200	5907558423907
12-224	24	38	20/200	5907558423914

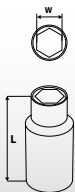

Ref.	W[mm]	L[mm]	⊖	EAN
12-310	10	78	10/100	5907558423921
12-311	11	78	10/100	5907558423938
12-312	12	78	10/100	5907558423945
12-313	13	78	10/100	5907558423952
12-314	14	78	10/100	5907558423969
12-315	15	78	10/100	5907558423976
12-316	16	78	10/100	5907558423983
12-317	17	78	10/100	5907558423990
12-319	19	78	10/50	5907558424003
12-321	21	78	10/50	5907558424010
12-322	22	78	10/50	5907558424027
12-324	24	78	10/50	5907558424034

Nasadki udarowe

Impact sockets / Schlagaufsätze / Насадки ударные / Патрон перфораторный / Gépi dugókulcskészlet / Βράχταρ pερcutιe / Příkladový nástavec / Příkladový nástavec / Udarni nasadni ključ / Kalimo antgaliai / Triecienpuzgalis / Löökötsakud / Ударни наставки / Ударни насадки / Ударне капиче / Υπόδοxής κρουσικου ανταλλακτικου / Llaves de vaso para atornilladores de impacto / Bussola esagonale / Bocais de impacto / Douilles de choc



CrV
steel 1/2" x10



Ref.	W [mm]	⊖	EAN
12-101	10, 12, 13, 14, 16, 17, 19, 21, 22, 24	0/20	5907558414509



CrV
steel 1/2" x11



Ref.	W [mm]	⊖	EAN
12-102	10, 11, 12, 13, 14, 16, 17, 19, 21, 22, 24	0/10	5907558414516



CrMo
steel 1/2" x10



Ref.	W [mm]	⊖	EAN
12-107	10, 12, 13, 14, 15, 17, 19, 21, 22, 24	0/10	5907558414547



CrMo
steel 3/4" x8



Ref.	W [mm]	⊖	EAN
12-115	26, 27, 29, 30, 32, 35, 36, 38	0/6	5907558414523



CrMo
steel 1" x9



Ref.	W [mm]	⊖	EAN
12-105	27, 30, 32, 35, 36, 38, 41, 42, 50	0/2	5907558414530



CrMo
steel 1/2" x9



Ref.	W [mm]	⊖	EAN
12-110	E10, E11, E12, E14, E16, E18, E20, E22, E24	0/20	5907558414554

Zestaw nasadek

Socket set / Aufsatzset / Набор запчастей торцевых / Набор насадок торцевых / Dugókulcs készlet alufelnihez, vékonyfalú / Set duze / Sada nasadek / Súprava nástr. ključov / Garnitura nasadnih ključev / Antgalių rinkinys / Мисурци комплекси / Padrunikomplekt / Геодор компл / Šesterokutne karice / Геодора сет / Συλλογή καρδικιών / Llaves de vaso / Set di boccole / Kit de bicos / Jeu de douilles / Set van doppen



Ref.	W [mm]	⊖	⊕	EAN
12-350	17, 19, 21	0/20		5907558435849

Klucze udarowe torx

Impact Torx bit socket set / Torx-Schlagschrauber-Satz / Набор ударных торцевых ключей Torx / Набор ключів ударних «Торх» / Torx bitkészlet gépi / Chef cu impact torx / Nástrčné klíče torx / Rázové klíče torx / Udarni nasadni ključji Torx / Smúginiai raktai „TORX“ / Tricenciatslēgas torx / Torx-löökvõtmed / Ударни ключове torx / ударни клjučеви torx / Udarni ključеви torx / Σετ κρουστικά μπουλονόκλειδα Torx / Llaves de impacto torx / Insetti Torx / Jogo de chaves de percussão torx / Clés à choc torx / Torx slagsleutels



Ref.	W [mm]	⊖	EAN
08-712	T25, T27, T30, T40, T45, T50, T55, T60	0/20	5907558418620

Przewód ciśnieniowy spiralny

High pressure spiral hose / Spiraldruckleitung / Шланг сжатого воздуха спиральный / Шланг високого тиску / Pneumatikus spiráltömlő / Furtun spiral presiune înaltă / Tlakové potrubí spirálové / Vysokotlaká špirálová hadica / Visokotlačna spiralna gibka cev / Spiralinė aukšto slėgio žarna / Spirálveida gaisa cauruvlads / Kõrgsurveoolik (spiraal) / Маркуч за компресор / Spiralo crijevo najlonsko / Crevo za visoki pritisak / Σπιρωειδής ρύγχος υψηλής πίεσης / Tubo de presión / Tubo a spirale in nylon / Cabo de tensão espiral / Durite de pression hélicoïdale / Spiraal drukleiding

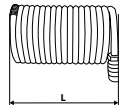

Ref.	L [m]	⊖ mm	⊕ mm	⊖	EAN
12-070	5	6,5	10,0	0/50	5907558414448
12-071	10	6,5	10,0	0/20	5907558414455
12-072	15	6,5	10,0	0/20	5907558414462
12-074	5	8,0	12,0	0/25	5907558414479
12-075	10	8,0	12,0	0/20	5907558414486
12-076	15	8,0	12,0	0/15	5907558414493



Ref.	L [m]	⊖ mm	⊕ mm	⊖	EAN
14-808	5	5,0	8,0	0/50	5907558457865
14-804	10	5,0	8,0	0/25	5907558444681
14-806	15	5,0	8,0	0/25	5907558444698

Przewód ciśnieniowy zbrojony

High pressure reinforced hose / Druckleitung verstärkt / Шланг высокого давления армированный / Шланг високого тиску, армований / Pneumatikus tömlő / Furtun armat presiune înaltă / Tlakové potrubí vyztužené / Vysokotlaká hadica / Visokotlačna gibka cev / Sustspringta aukšto slėgio žarna / Augstspiediena gaisa cauruvlads / Tugevatudat kõrgsurveoolik / Маркуч за вис. налягане / crijevo za visoki pritisak / Crevo za visoki pritisak / Εισχυμένος ρύγχος υψηλής πίεσης / Tubo de presión reforzado / Tubo a pressione rinforzato / Cabo de tensão armado / Durite de pression armée



Ref.	L [m]	⊖ mm	⊕ mm	⊖	EAN
14-800	15	10,0	15,0	0/10	5907558444667
14-802	15	12,0	17,0	0/10	5907558444674



Ref.	L [m]	⊖ mm	⊕ mm	P max [BAR]	⊖	EAN
12-079	50	8,0	13,0	19	0/1	5907558414936
12-080	50	10,0	15,0	17	0/1	5907558414943
12-081	50	12,0	17,0	13	0/1	5907558414950

Szybkozłączka

Quick coupler / Schnellkupplungen / Быстросменная муфта / Муфта швидко рознімна / Pneumatikus gyorscsatlakozó / Conector rapid / Rychlospojka / Rýchlospojka / Hitra spojka / Greitloij jungtis / Ātrsavenotājs / Kiirühendus / Бърза връзка / Spojnica / Brzo odvajanje / Συζευκτήρας ταχείας απελευθέρωσης / Acoplador rápido / Connettore rapido con presa per tubo / União rápida / Rapport rapide / Snelkoppeling



Ref.	⌀ mm	⌀ mm	⊘	EAN
12-600	4	6	0/36	5907558417685
12-601	6	8	0/27	5907558417692
12-602	8	10	0/27	5907558417708



Ref.	⌀ mm	⊘	EAN
12-620	7	0/36	5907558417814
12-621	8	0/36	5907558417821
12-622	10	0/36	5907558417838
12-623	12	0/36	5907558417845



Ref.	⌀ mm	⊘	EAN
12-630	7	0/36	5907558417890
12-631	8	0/36	5907558417906
12-632	10	0/36	5907558417913



Ref.	⊘ [°]	⊘	EAN
12-635	1/4	0/36	5907558417920
12-636	3/8	0/36	5907558417937
12-637	1/2	0/36	5907558417944



Ref.	⊘ [°]	⊘	EAN
12-645	1/4	0/36	5907558417975
12-646	3/8	0/36	5907558417982



Ref.	⊘ [°]	⊘	EAN
12-650	1/4	0/36	5907558417999
12-651	3/8	0/36	5907558418002

Końcówka do szybkozłączki

Quick coupler tip / Endstück für Schnellkupplung / Наконечник быстрого соединения / Насадка для швидко рознімної муфти / Pneumatikus csatlakozó külsőmenet- gyorsvég / Piesă de conectare rapidă / Koncovka pro rychlospojku / Nástavec rýchlospojky / Nastavek za hitro spojko / Greitloijes jungties antgalis / Ātrsavenojuma uzgalis / Kiirühendusotsak / Накраїник за бърза връзка / Наставок за spojnicu / Крај за brzo priključivanje / Κεφαλή ταχείας σύνδεσης / Boquilla para acoplador rápido / Connettore rapido con presa per tubo / Ponta para uniões rápidas / Embout pour raccord rapide / Eindstuk voor snelkoppeling



Ref.	⌀ mm	⌀ mm	⊘	EAN
12-605	6	8	0/27	5907558417715
12-606	8	10	0/36	5907558417722



Ref.	⊘ [°]	⊘	EAN
12-640	1/4	0/30	5907558417951
12-641	3/8	0/36	5907558417968



Ref.	⌀ mm	⊘	EAN
12-625	7	0/36	5907558417852
12-626	8	0/36	5907558417869
12-627	10	0/36	5907558417876
12-628	12	0/36	5907558417883



Ref.	⊘ [°]	⊘	EAN
12-655	1/4	0/36	5907558418019
12-656	3/8	0/36	5907558418026

Złącze do węży

Hose connection / Schlauchverbinder / Соединители для шланга / Арматура до шланга / Pneumatikus tömlőtoldaló / Imbinare de furtun / Spojka pro hadici / Spoj na hadicu / Konektor za cev / Jungtis žarna / Sļūtenes savienotājs / Voalikiühendus / Съединение за шланга / Sprega za cijev / Spoj za crevo / Συνδεσμοί εύκαμπτου σωλήνα / Junta para manguera / Connettore per tubo / União p. Mangueira / Raccord pour flexible / Verbindingsstuk voor slang



Ref.	⌀ mm	⊘	EAN
12-610	6	0/36	5907558417739
12-611	8	0/36	5907558417746
12-612	10	0/36	5907558417753
12-613	12	0/36	5907558417760

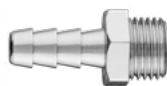

Ref.	⌀ mm	⊘ [°]	⊘	EAN
12-615	6	1/4	0/36	5907558417777
12-616	10	1/4	0/36	5907558417784
12-617	10	1/2	0/36	5907558417791
12-618	12	1/2	0/36	5907558417807

Pistolet natryskowy

Spray gun / Sprühpistole / Пистолет-распылитель / Фарбувальний / Festékszóró pisztoly / Pistol de duș / Stříkací pistole / Striekovácia pištoľ / Brizgalna pištola / Purškimo pistoletas / Pistole-smidzinātājs / Pihustuspüstol / Пистолет - нулевузатвор / Pištolj za prskanje / Pištolj za prskanje / Πατάλι ψεκαγού / Pistola de aspersion / Pistola a spruzzo / Pistola de borifjar / Pistolet à projection / Sputtpistool



Ref.	⊞	EAN
14-700	1/20	5907558452075



Ref.	⊞	EAN
14-702	1/12	5907558452082



Ref.	⊞	EAN
14-703	1/20	5907558452099



Ref.	⊞	EAN
14-704	1/8	5907558452105

Pistolet do przedmuchiwania

Blowing gun / Pistole zum Durchblasen / Пистолет для продувания / Пистолет до продування / Pneumatikus lefúvatópisztoly / Pistol de baleia / Pistole pro profukování / Prefukovacia pištoľ / Izpihoválna pištola / Prapūtimo pistoletas / Caurpūšanas pistole / Lāblīputuspūstol / Пистолет за продување / Pištolj za ispuhivanje / Pištolj za prodnavanje / Πατάλι αέρος / Pistola de limpezia a chorro de aire / Pistola aria compressa / Pistola para soprar / Pistolet de soufflage / Αβίασπιστολ

Zestaw lakierniczy

Lacquier set / Lackierset / Набор для лакирования / Комплект до лакофарбувальних робіт / Kompressor tartozékészlet / Garnitură de lacuit / Lakovací sada / Súprava na lakovanie / Komplet za lakiranje / Kompletas dažytojui / Laku komplekts / Lakkimiskomplekt / Комплект за лакиране / Set za lakiranje / Pribor za lakiranje / Σετ βερνικώματος / Juego de herramientas para barnizado / Pistola a spruzzo in kit / Kit p. Verniz / Jeu d'outils de peinture / Lakset

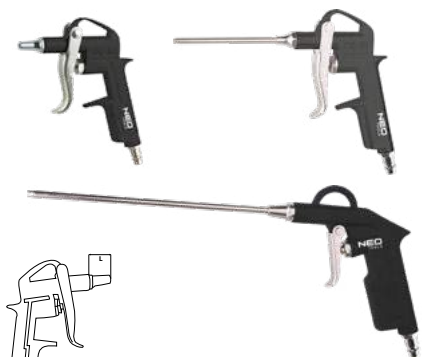

Ref.	L[mm]	⊞	EAN
14-708	1/100	1/100	5907558452129
14-710	83	1/100	5907558452136
14-712	220	1/40	5907558452143



Ref.	⊞	EAN
14-699	1/10	5907558452068

Pistolet do pompowania

Inflating gun / Pumpenpistole / Пистолет для подкачки шин / Пистолет до помпування / Kerékfúvató pisztoly nyomásmérővel / Pistol de pompare / umflare / Plnicí pistole / Pumprovacia pištoľ / Pištoľa za črpanje / Siurbimo pistoletas / Sūkņēšanas pistole / Pūstoļpump / Пистолет за изпомване / Pištoľ za pumpanje / Pištoľ za pumpanje / Πιστόλι φυσικούματος ελαστικών / Pistola para inflar / Gonfiatore per pneumatici / Pistola p. Bomba / Pistolet de pompage / Pomppistol



Ref.	⊞	EAN
14-714	1/40	5907558452150



Ref.	⊞	EAN
14-716	1/20	5907558452167

Pistolet do mycia

Washing gun / Reinigungspistole / Пистолет-распылитель для мытья / Пистолет для мийки / Alváztvédő szórópisztoly / Pistol de spălat / Pistole na mytí / Čistiaca pištoľ / Pištoľa za pranje / Plovimo pistoletas / Mazgāšanas pistole / Pesemipūstoľ / Пистолет за миење / Pištoľ za pranje / Pištoľ za pranje / Πιστόλι πλυσής / Pistola de limpiar / Pistola per pulizia / Pistola p. Limpeza / Pistolet de lavage / Waspiistol



Ref.	⊞	EAN
14-706	1/20	5907558452112

Pistolet do konserwacji

Maintenance gun / Wartungspistole / Антикоррозионный пистолет со шлангом / Фарбопульт / Alváztvédő szórópisztoly támlóvel / Pistol de conservare / Pistole pro údržbu / Konzerváčna pištoľ / Pištoľa za nanašanje zaščite / Oro išsiurbimo pistoletas / Konservācijas pistole / Hoolduspūstoľ / Пистолет за консервация / Pištoľ za održavanje / Pištoľ za konzerviranje / Πιστόλι ψεκασμού για συντήρηση / Pistola de conservación / Pistola per rivestimenti / Pistola p. Conservação / Pistolet d'entretien / Onderhoudspistol



Ref.	⊞	EAN
14-720	1/20	5907558452181

Pistolet do piaskowania

Sandblasting gun / Pistole zum Sandstrahlen / Пескоструйный пистолет с бачком / Пистолет до піскоструменевої обробки / Homokfúvó pisztoly tartállyal / Pistol de sablare / Piskovacci pistole / Pieskovacia pištoľ / Pištoľa za peskanje / Smeliavimo pistoletas / Smilšstrūklāšanas pistole / Liivaprits / Пистолет за масно / Pištoľ za pjeskarenje / Pištoľ za peskarenje / Πιστόλι αμμοβολής / Pistolas de decapado por arena / Pistola per sabbatura / Pistola p. Areia / Pistolet à sablage / Zandblaaspistol



Ref.	⊞	EAN
14-724	1/10	5907558452204

Piasek

Sand / Sand / Песок / Pisco / Ásvány homok homokfúvóhoz / Nisip / Pisek / Piesok / Pesek / Dirželis / Smiltis / Līv / Κοκαν / Pjesak / Pesak / Arena / Sabbia sintetica / Areia / Sable / Zand



Ref.	m [kg]	⊞	EAN
12-562	1	0/20	5907558417586
12-564	10	0/2	5907558417593

Filtr odwadniacz z reduktorem

Draining filter with pressure reducer / Entwässerungsfilter mit Reduktionsstück / Филтър-редуктор / Филтър сепараторний з редуктором / Viztelenítő szűrő nyomáscsökkentővel, fémházas / Filtru - dezodorizant cu reductor / Odvodňovací filtr s reduktorem / Odvodňovací filter s reduktorem / Odvodni filter z reduktorjem / Filtras- džiuvintuvas su reduktoriumi / Atüdeñošanas filtrs ar reduktoru / Reduktoriga veefilter / Филтър за отводняване с редуктор / Filtrar za upravljanje vode s reduktorom / Odvodni filter sa reduktorom / Φίλτρο-διαχωριστής με μειωτήρα / Filtra de drenaje con reductor / Filtra di drenaggio con riduttore di pressione / Filtra com redutor / Filtre purgeur à réducteur / Filter drainage met reductiestuk



1/2"

0-12
bar

20
µm

CE

Ref.	Ø	EAN
14-734	1/25	5907558452235

Filtr odwadniacz

Draining filter / Entwässerungsfilter / Филтър / Филтър сепараторний / Viztelenítő szűrő, fémházas / Filtru - dezodorizant / Odvodňovací filtr / Odvodňovací filter / Odvodni filter / Filtras- džiuvintuvas / Atüdeñošanas filtrs / Veefilter / Филтър за отводняване / Filtrar za upravljanje vode / Odvodni filter / Φίλτρο-διαχωριστής / Filtra de drenaje / Filtra di drenaggio / Filtra / Filtre purgeur / Filter drainage



1/2"

0-9
bar

CE

Ref.	Ø	EAN
14-732	1/50	5907558452228



1/2"

0-9
bar

CE

Ref.	Ø	EAN
14-730	1/25	5907558452211



GRAPHITE

POWER IN YOUR HANDS



3
YEARS
WARRANTY

graphite.pl

GRAPHITE
POWER IN YOUR HANDS



3 lata gwarancji na WSZYSTKIE elektronarzędzia, urządzenia, akumulatory i ładowarki marki GRAPHITE. Regulamin dostępny na graphite.pl
3-year warranty on all power tools, devices, batteries and chargers. Terms and conditions are available on en.graphite.pl
Гарантия распространяется на весь электроинструмент GRAPHITE, включая батареи. Подробная информация доступна на сайте ru.graphite.pl

GRAPHITE to

- ▶ elektronarzędzia przeznaczone do intensywnego użytkowania, przy obciążeniach bliskich profesjonalnym,
- ▶ szeroki asortyment wysokiej jakości elektronarzędzi dla branży motoryzacyjnej i ogólnobudowlanej
- ▶ produkty z optymalnym zestawem cech: wytrzymałe, o mocnych silnikach, ergonomicznie zaprojektowane
- ▶ gwarancja efektywnie wykonanej pracy i dobrze wydanych pieniędzy

GRAPHITE is...

- ▶ power tools designed for intensive semi-professional use
- ▶ a wide range of high quality power tools for the automotive and general construction industry
- ▶ products with optimum set of features: durable, with powerful motors and ergonomically designed
- ▶ a guarantee of job well done and money well invested

GRAPHITE это...

- ▶ электроинструмент, предназначенный для интенсивного использования при нагрузках, приближенных к профессиональным
- ▶ широкий ассортимент высококачественного электроинструмента для автомобильной и общестроительной промышленности
- ▶ продукты с оптимальным набором качеств: прочные, с мощными двигателями и эргономичной конструкцией
- ▶ гарантия достижения запланированных результатов и хорошего вложения денег

Zapraszamy na kanały marki GRAPHITE w mediach społecznościowych

Come and browse GRAPHITE social media channels

Приглашаем на каналы марки GRAPHITE в социальных сетях



GRAPHITE

Informacje o nowościach produktowych, porady oraz VIDEO

Information on new products, advice and VIDEOS

Информация о новых продуктах, советы и ВИДЕО

YouTube
GRAPHITEmov



VIDEO produktowe, porównania i testy produktów w wielu wersjach językowych

Product related VIDEOS, product comparisons and tests in multiple language versions

ВИДЕО о продуктах, сравнение и тесты продуктов в различных языковых версиях

10⁺
YEARS
SPARE PARTS
AVAILABILITY

* Części zamienne dostępne na: gtxservice.pl
* Spare parts available on: gtxservice.pl
* Запасные части на: gtxservice.pl

f @GRAPHITE

▶ GRAPHITEmov

graphite.pl

GRAPHITE

ENERGY+
system



JEDEN akumulator
WIELE możliwości

ONE battery
MANY possibilities

ОДНА аккумуляторная батарея
МНОЖЕСТВО возможностей



System Energy+

System Energy+ to nowa linia produktów zasilanych akumulatorami tego samego typu. Dzięki takiemu rozwiązaniu istnieje możliwość dowolnej konfiguracji zestawu produktów i doboru optymalnej ilości potrzebnych akumulatorów.

Energy+ System

Energy+ System is the new range of products powered with batteries of the same type. This solution allows to configure set of products at will and choose optimal number of required batteries.

Система Energy+

Система Energy+ это новая линейка продуктов с питанием от аккумуляторных батарей одного и того же типа. Благодаря такому решению можно по собственному усмотрению сконфигурировать набор инструмента и подобрать нужное количество аккумуляторных батарей.

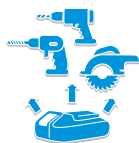

**KOMPATYBILNY
COMPATIBILITY
СОВМЕСТИМАЯ**

możliwość współdzielenia akumulatorów przez różne typy elektronarzędzi

batteries can be shared among various types of power tools

возможность использования аккумуляторных батарей для работы с разными типами электроинструмента



**MOBILNY
MOBILITY
МОБИЛЬНАЯ**

nieograniczone przewodem zasilającym operowanie urządzeniem

power tool operation unrestricted by power cord

работа с электроинструментом, не ограниченная шнуром питания



**WYDAJNY
EFFICIENCY
ЭФФЕКТИВНАЯ**

możliwość ładowania akumulatora w dowolnej chwili bez ryzyka utraty jego pojemności

the battery can be charged at any moment, without risk of degrading

зарядка аккумулятора возможна в любой момент, без риска потери его емкости



**WYTRZYMAŁY
DURABILITY
НАДЕЖНАЯ**

wysokiej jakości materiały i wytrzymałe podzespoły

high quality materials and long lasting components

высококачественные материалы и надежные комплектующие



**KOMFORT PRACY
COMFORT AT WORK
КОМФОРТ РАБОТЫ**

ergonomiczna konstrukcja i nowoczesne wzornictwo

ergonomic and modern design

эргономичная конструкция и современный дизайн

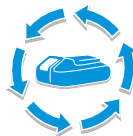

**UNIERSALNY
VERSATILITY
УНИВЕРСАЛЬНАЯ**

dowolność i łatwość zestawienia elektronarzędzia z akumulatorem

power tool can be freely and easily matched with battery

неограниченный и простой подбор аккумуляторной батареи к инструменту

ELEKTRONARZĘDZIA I AKCESORIA

POWER TOOLS AND ACCESSORIES

ЭЛЕКТРОИНСТРУМЕНТЫ И АКСЕССУАРЫ

**10⁺
YEARS
SPARE PARTS
AVAILABILITY**

* Części zamienne dostępne na: gtxservice.pl

* Spare parts available on: gtxservice.pl

* Запасные части на: gtxservice.pl

f @GRAPHITE

▶ GRAPHITEmov

graphite.pl

Wiertarko-wkrętarka akumulatorowa

Cardless drill / Akkubohrschrauber / Дрель-шуруповерт аккумуляторная / Дрель-шуруповерт аккумуляторный / Akkus útvefúró / Vormasina-surubelmita cu acumulator / Akumulátorová vrtačka-šroubovák / Akumulátorový vrtací skrutkovač / Akumulatorski vrtnik-vijačnik / Akumulatorski grežtuvas - suktuvas / Akumulatora urbjmašīna-skrūvgriezis / Akutrell / Аккумулятор пробивен винтоверт / Akumulatorska bušilica -izvijadž / Akumulatorska bušilica - odvijač / Εναρφορτζιμενο βρανανο-κατοβίβο / Taladradora atornilladora a batería / Trapano avvitatore a batteria con percussione / Aparafuradora de batería / Perceuse-visseuse à batterie / Accu boor-draaimachine



18V
Li-Ion



2.0 - 13 mm



2x 18V 2Ah
Li-Ion



I: 0-350 min⁻¹
II: 0-1250 min⁻¹



1-19 + drilling



35 Nm



55 Nm

SKU	kg	0/4	EAN
58G006-SET2	5,02	0/4	5902062503640



18V
Li-Ion



2.0 - 13 mm



18V 2Ah
Li-Ion



I: 0-500 min⁻¹
II: 0-1700 min⁻¹



1-16 + drilling



38 Nm



58 Nm

SKU	kg	0/4	EAN
58G019-SET1	4,56	0/4	5902062503664



18V
Li-Ion



2.0 - 13 mm



18V 2Ah
Li-Ion



I: 0-500 min⁻¹
II: 0-1700 min⁻¹



1-16 + drilling



38 Nm



58 Nm

SKU	kg	0/4	EAN
58G020-SET2	5,06	0/4	5902062503688

GRAPHITE
POWER IN YOUR HANDS



3 lata gwarancji na WSZYSTKIE elektronarzędzia, urządzenia, akumulatory i ładowarki marki GRAPHITE. Regulamin dostępny na graphite.pl
3-year warranty on all power tools, devices, batteries and chargers. Terms and conditions are available on en.graphite.pl
Гарантия распространяется на весь электроинструмент GRAPHITE, включая батареи. Подробная информация доступна на сайте ru.graphite.pl

Wiertarko-wkrętarka akumulatorowa

Cardless drill / Akkubohrschrauber / Дрель-шуруповерт аккумуляторная / Дрель-шуруповерт аккумуляторный / Akkus útvefúró / Bormasina-surubelita cu acumulator / Akumulátorová vrtačka-šroubovák / Akumulátorový vrtací skrutkovač / Akumulatorski vrtalniki-vijačnik / Akumulatora uzvāzētas - suktavas / Ударен зайковерт / Akumulatorski zavijač / Akumulatorski novojni čep / Εναρτηρηζόμενο δριλενο-καταβίβιο / Taladradora atornilladora a batería / Trapano avvitatore a batteria con percussione / Απαρτηραζοδρα δε bateria / Percuisse-visseuse à batterie / Accu boor-draaimachine

ENERGY+
system

18V
Li-Ion



SKU	[kg]	[O/5]	EAN
58G010	1,1	0/5	5902062035288

ENERGY+
system

18V
Li-Ion



YouTube
VIDEO CONTENT



SKU	[kg]	[O/5]	EAN
58G019	1,2	0/5	5902062045942

Zakrętarka akumulatorowa ENERGY+

Cardless driver / Akku-Schraubmaschine / Гаїковерт аккумуляторный / Муфтоверт аккумуляторный / Akkus útvecsavarozó / Inchižator de acumulator / Akumulátorový šroubovák / Akumulátorový šroubovák / Akumulatorski vrtalniki / Akumulatorinis suktavas / Akumulatora uzvāzētas grēžtavas - suktavas / Ударен зайковерт / Akumulatorski zavijač / Akumulatorski novojni čep / Εναρτηρηζόμενο καταβίβιο / Dispositivo de cierre a batería / Avvitatore a batteria ad impulsi / Máquina de travar com batería / Visseuse à batterie / Accu schroefmachine

ENERGY+
system

18V
Li-Ion

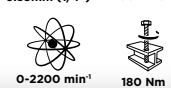

SKU	[kg]	[O/5]	EAN
58G012	1,2	0/5	5902062035400

ENERGY+
system

18V
Li-Ion

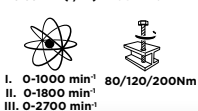
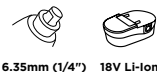

SKU	[kg]	[O/5]	EAN
58G024	1,1	0/5	5902062059765

Klucz udarowy akumulatorowy ENERGY+

Impact wrench / Schlüsselschlüssel / Ключ ударный / Муфтоверт ударный / Útvecsavarozó / Cheie cu percutie / Rázový úťahovák / Prikrkový kľúč / Udarni vijačnik / Atskelimo plaktukas / Sitama atslēga / Lőkivó / Ударен ключ / Udarni kľuč / Pneumatski kľuč / Ключи кроуток / Llave de impacto / Avvitatore ad impulsi / Chave de impacto / Clef à chocs / Slagsleutel

ENERGY+
system

18V
Li-Ion

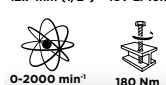

SKU	[kg]	[O/5]	EAN
58G018	1,8	0/5	5902062045935

Pilarka szablowa akumulatorowa ENERGY+

Sabre saw / Motorstichsäge / Сабельная пила / Пилка шабельна / Szabljafűrész / Ferástrá sabie / Savlova pila / Chvostová píla / Sabljasta žaga / Tiesinis pjūklas / Zobenžagis / Saabelsaag / Саблен трупон / Sabljasta píla / Sabljasta testera / Σαβελόεσα / Sierra de vaivén / Segá universale / Serra de sabre / Scie à sabre / Sabelzaag

ENERGY+
system

18V
Li-Ion

YouTube
VIDEO CONTENT

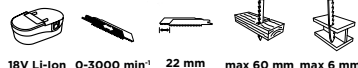

SKU	[kg]	[O/5]	EAN
58G017	1,8	0/5	5902062035928

ELEKTRONARZĘDZIA I AKCESORIA

POWER TOOLS AND ACCESSORIES

ЭЛЕКТРОИНСТРУМЕНТЫ И АКЦЕССУАРЫ

10
YEARS
SPARE PARTS
AVAILABILITY

* Części zamienne dostępne na: gtxservice.pl
* Spare parts available on: gtxservice.pl
* Запасные части на: gtxservice.pl

f @GRAPHITE

▶ GRAPHITEmov

graphite.pl

Zszlifierka kątowa akumulatorowa ENERGY+

CORDLESS angle grinder / Winkelschleifer / Аккумуляторная угловая шлифовальная машина / Шліфмашина кутова (богарна) / Akkus sarokcsiszoló / Masina de sleiuit unghiulara / Úhlová bruska / Uhlová bruska / Kotni brusnik / Kämpinis šlijfuoklis / Leňka slipmašina / Nurkluhviija / Ёношнауџ / Kutna brusilica / Ugoana brusilica / Губакоу трёбеџо / Amoladora angular / Smerigratlirice angolare / Disco de limar p. cantos / Meuleuse d'angle / Versteckschuurmachine



18V
Li-Ion



18V Li-Ion



10000 min ⁻¹	115 mm	M14	SKU	[kg]	[l]	EAN
			58G003	1,5	0/4	5902062039518



18V
Li-Ion



18V Li-Ion



10000 min ⁻¹	125 mm	M14	SKU	[kg]	[l]	EAN
			58G026	1,7	0/4	5902062059772



Zszlifierka mimośrodowa akumulatorowa ENERGY+

CORDLESS orbital sander / Exzenterschleifmaschine / Аккумуляторная эксцентриковая шлифовальная машина / Шліфмашина ексцентрикова / Akkus excentersziszoló / Masina de sleiuit excentrica / Excentrická bruska / Excentrická bruska / Excentricni brusnik / Excentrinis šlijfuoklis / Excentra slipmašina / Ekstsentrikluhviija / Шліфмашина ексцентрична / Vibracijska bušilica / Excentriczna brusilica / Ексцентро трёбеџо / Lijadora excentrica / Levigatrice orbitale / Disco de limar / Meuleuse excentrique / Excenter schuurmachine



18V Li-Ion Ø 125 mm



2.7 mm	5000/7000/9000 min ⁻¹	10000/14000/18000 min ⁻¹	SKU	[kg]	[l]	EAN
			58G014	1,1	0/4	5902062035424



Opalarka akumulatorowa

CORDLESS Heat Gun / Schnurlose Heißluftpistole / Аккумуляторная тепловая пушка / Акумуляторна теплова гармата / Akkus hőlégfűtő / Arma de căldură fără fir / Akumulátorová tepelná pistola / Akumulátorová tepelná pistola / Brezžični toplinski pištol / Akumulátorinis šilumos pistoletas / Bežvada karštuma pistole / Juhtmeta soojuspüstol / Bežični toplinjeni puštel / Bežični toplinski pištol / Bežični toplinski puštel / Πιστόλι θερμότητας χωρίς καλώδιο / Pistola de calor sin cuerda / Pistola termica a batteria / Pistola de calor sem fir / Pistole à chaleur sans fil



18V
Li-Ion



18V Li-Ion

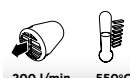

200 l/min	550°C	SKU	[kg]	[l]	EAN
		58G082	0,6	0/5	5902062503497



Kompresor akumulatorowy z osprzętem

Inflator with accessories / Akku-Kompressor mit Zubehör / Компрессор аккумуляторный с оснасткой / Компрессор аккумуляторний з принадлежностями / Légkompresszor tartozékokkal / Compressor de cumulator cu accesorii / Akumulátorový kompresor s príslušenstvom / Akumulátorový kompresor s príslušenstvom / Akumulátorový kompresor s opremo / Automobilišnis kompresorius su įranga / Akumulatora kompresors ar piederumiem / Akukompressor koos tarvikutega / Аккумуляторен компресор с оборудване / Akumulátoriskii kompresor s opremot / Baterijski akumulator s priborom / Συμπιεστής εναποφορτιζόμενος / με βοηθητική εξάρτηματα / Compressor a batería con accesorios / Compresore a batteria con accessori / Compressor de ar para bateria con accesorios / Compresseur à batterie avec accessoires / Batterijkompressor met accessoires



18V
Li-Ion



18V Li-Ion



max 7 bar

SKU	[kg]	[l]	EAN
58G041	0,8	0/5	5907558480085



18V
Li-Ion



18V Li-Ion



3 min



11 mm



SKU	[kg]	[l]	EAN
58G040	0,4	0/5	5907558480078

Pistolet klejowy

Glue gun / Leimipistole / Пуштел клеюв / Пуштел клеюв / Ragasztópistoly / Pistol de lipi / Lepići pistole / Pištol lepilica / Lepilna pištola / Klijiv pistoletas / Limes pistole / Limipistol / Пуштелом за савунок / Pištolj za plastiku / Pištolj za plastiku / Πιστόλι βερυκόπιας / Pistola surtidora de pegamento / Pistola incollante / Pistola p. cola / Pistolet à colle / Lijmpistol /

GRAPHITE
POWER IN YOUR HANDS



3 lata gwarancji na WSZYSTKIE elektronarzędzia, urządzenia, akumulatory i ładowarki marki GRAPHITE. Regulamin dostępny na graphite.pl
3-year warranty on all power tools, devices, batteries and chargers. Terms and conditions are available on en.graphite.pl
Гарантія розпростається на весь електронструмент GRAPHITE, вичнак батерей. Подробна інформація доступна на сайті ru.graphite.pl

Latarka akumulatorowa ENERGY+

Cordless flashlight / Taschenlampe / Акумуляторний фонарь / Ліхтарик / Akkus lámpa / Lanterna / Bateria / Lampa / Svetilka / Žibintuvelis / Lukturis / Pīleli / Фенерче / Baterijska lampa / Lampa / Φακός / Linterna de mano / Torcia / Lanterna / Torche / Zaklamp



18V
Li-Ion

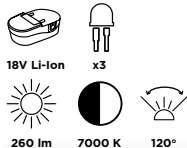

18V Li-Ion

x3

260 lm

7000 K

120°

SKU	[kg]	[l]	EAN
58G007	0,3	0/10	5902062035354

Adapter USB - latarka LED

USB adapter - LED flashlight / USB-adapter - LED-taschenlampe / Переходник USB - фонарик LED / Adapter USB — ліхтарик LED / USB adapter - LED lámpa / Adaptor USB - lanterna LED / USB-adapter - LED svitilka / USB adapter - LED baterka / Adapter USB - svetilka LED / Jungtis / USB-žibintuvelis LED / USB adapters - LED lukturis / USB-adapter - LED-taskulap / USB адаптер - LED фенер / Adapter USB - LED svjetiljka / USB adapter - LED lampa / Φορτιστή φορητό με USB / και φακο LED / Adaptor USB - linterna LED / Adattatore USB - torcia elettrica LED / Adaptateur USB - torche LED / USB adapter - LED zaklamp



18V
Li-Ion



18V Li-Ion



SKU	[kg]	[l]	EAN
58G025	0,11	0/50	5907558480092

Akumulator systemu ENERGY+

Battery / Akumulator / Акумуляторная батарея / Акумулятор / Akkumulator / Acumulator / Akumulátor / Akumulator / Akumulator / Akumulatorijs / Akumulators / Aku / Акумулятор / Akumulator / Akumulator / Ηλεκτρικός συσσωρευτής / Bateria / Batteria / Bateria / Batterie / Accu



18V
Li-Ion



18V Li-Ion

58G001 - 2 Ah
58G004 - 4 Ah
58G086 - 6 Ah

SKU	[kg]	[l]	EAN
58G001	0,4	0/8	5902062035295
58G004	0,7	0/10	5902062035325
58G004	0,95	0/10	5902062501158

Torba na narzędzia

Tool bag / Werkzeugtasche / Сумка для инструментов / Торба інструментальна / Szerszámtáska / Geanta scule / Brašna na nářadí / Taška na montérská / Torba za orodje / Krepšys įrankiams / Instrumentu soma / Тööriistakott / Чанма за инструменти / Torba za alat / Torba za alat / Ζάκος για εργαλεία / Bolsa para herramientas / Borsa per attrezzi / Saco p. ferramentas / Sac à outils / Gereedschapstas



SKU	[kg]	[l]	EAN
58G092	1,7	0/4	5902062506801

Ładowarka do akumulatorów ENERGY+

GRAPHITE ENERGY+ battery charger / Akku-Ladegerät / Зарядное устройство системы GRAPHITE ENERGY+ / Зарядний пристрій для акумуляторів / Töltő / Incarcator pentru acumulatorie / Nabijačka baterij / Nabijačka akumulatora / Połnilnik za akumulatorje / Akumulatorių įkroviklis / Akumulatoru lādētājs / Akulaadja / Зарядно устройство за акумулаторите / Punjač za akumulate / Punjač za akumulator / Φορτιστής / Cargadora para baterias / Carica batterie / Carregador de baterias / Chargeur à batteries / Accuoplader



18V
Li-Ion



18V 230V-50Hz
2.3 A



60 min

120 min

180 min

SKU	[kg]	[l]	EAN
58G002	0,3	0/8	5902062035301



18V
Li-Ion



18V 230V-50Hz
3.0 A



45 min

90 min

135 min

SKU	[kg]	[l]	EAN
58G085	0,7	0/10	5902062501141

ELEKTRONARZĘDZIA I AKCESORIA

POWER TOOLS AND ACCESSORIES

ЕЛЕКТРОІНСТРУМЕНТИ ТА АКЦЕСУАРИ

10 YEARS
SPARE PARTS
AVAILABILITY

* Części zamienne dostępne na: gtxservice.pl
* Spare parts available on: gtxservice.pl
* Замовні частини на: gtxservice.pl

@GRAPHITE

GRAPHITEMOV

graphite.pl

Szlifierka kątowa

Angle grinder / Winkelschleifer / Шлифмашина угловая / Шліфмашина кутівна / Sarokcsiszó / Masina unghiulară de șlefuit / Bruska úhlová / Bruska uhlová / Kotni brusilnik / Kampsin šlifvaoklis / Lenka sljpašina / Nurklijhija / Ξελοειλή / Brusilica kutna / Brusilica ugaona / Γωνιακός τροχός / Amoladora angular / Smerigliatrice angolare / Disco de limar p. cantos / Meuleuse d'angle / Versteckschuurmachine

900W

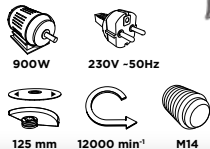

SKU	kg	mm	EAN
59G087	2,5	0/6	5902062024343

750W

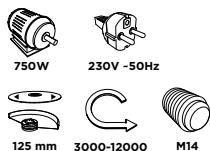

SKU	kg	mm	EAN
59G175	2,1	0/6	5907558480740

2600W



SKU	kg	mm	EAN
59G208	6,9	0/2	5902062034663

Polerka

Polisher / Poliermaschine / Полировальная машина / Машина полирувальна / Polírozógér / Masina de lustruit / Leštička / Leštička / Polirka / Poliravimo stakles / Pálēsanas mašina / Poleerija / Masina za poliranje / Aparat za poliranje / Polir mašina / Μηχανή σιλόματας / Pulidora / Lucidatore / Aparelho polidor / Polisseuse / Polijstmachine

1300W



SKU	kg	mm	EAN
59G243	3,9	0/4	5902062994967

1100W



SKU	kg	mm	EAN
59G244	2,6	0/4	5902062503589

Szlifierka mimośrodkowa

Orbital sander / Excenterschleifmaschine / Эксцентриковая шлифовальная машина / Шліфмашина ексцентрикова / Excentersiszó / Masina de șlefuit excentrica / Excentrická bruska / Excentrická brúška / Ekscentrični brusilnik / Ekscentrinis šlifvaoklis / Ekscentra sljpašina / Ekscentriklijhija / Шліфмашина ексцентрична / Vibračijska bušilica / Ekscentrična brusilica / Εκκετρο τρίβείο / Lijadora excentrica / Levigatrice rata-orbitale / Disco de limar / Meuleuse excentrique / Excenter schuurmachine

240W

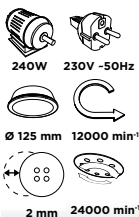

SKU	kg	mm	EAN
59G343	1,8	0/4	5902062000347

GRAPHITE
POWER IN YOUR HANDS

3
YEARS
WARRANTY

3 lata gwarancji na WSZYSTKIE elektronarzędzia, urządzenia, akumulatory i ładowarki marki GRAPHITE. Regulamin dostępny na graphite.pl
3-year warranty on all power tools, devices, batteries and chargers. Terms and conditions are available on en.graphite.pl
Γαραντία распространяется на весь электроинструмент GRAPHITE, включая батареи. Подробная информация доступна на сайте ru.graphite.pl

Zsliiferka stotowa

Bench grinder / Tischschleifmaschine / Машина шлифовальная настольная / Шліфмашина верстатна / Kőszűrűgép / Masina de slefuit de banc / Stolní bruska / Stovolá bruska / Namizni brusilnik / Stacionarus galgštavas / Galda slipmašina / Lauakáki / Намолен абрыхт / Stolina brusilica / Stona brusilica / Επιτραπέζιο τριβείο / Amoladora de banco / Smerigrilatrice da banco / Disco de limar de mesa / Meuleuse d'établi / Tafelschuurmachine

370W



370W 230V -50Hz



12,7/150 mm 2850 min⁻¹

SKU	[kg]	[]	EAN
596383	11,1	0/1	5902062593832

Pilarka szablowa

Sabre saw / Motorstichsäge / Сабельная пила / Пилка шабельна / Mini szűrőfűrész / Ferástráu sabie / Šavová píla / Chvostová píla / Sabljasta žaga / Tiesinis pjūklas / Zobenžagás / Saabelsaga / Саблен тרון / Sabljasta píla / Sabljasta testera / Знабóсага / Sierra de vaivén / Mini sega a gattuccio / Serra de sabre / Scie à sabre / Sijelzagaž

350W

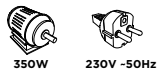

350W 230V -50Hz



0-2500 min⁻¹ 17 mm



max 60 mm max 6 mm



SKU	[kg]	[]	EAN
586960	2,9	0/6	5902062589606

Przecinarka do metalu

Metal cut saw / Metallschnitt-Säge / Резна по металлу / Пила по металлу / Fém vágótűrés / Ferástráu táiat metal / Píla na kov / Žaga za kovine / Pjaustytas metalu / Žagžés ar metalu / Metallist saega / Режец тרון за метал / Testera za rezanje metala / Testera za rezanje metala / Μεταλλικό πριόνι κοπής / Sierra de corte de metal / Sega per metallo / Serra de corte de metal / Scie à métaux

2600W



2600W 230V -50Hz

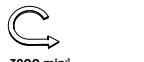

3800 min⁻¹



355/25,4 mm



SKU	[kg]	[]	EAN
596873	17	0/1	5902062504890

Wiertarka udarowa

Impact drill / Bohrhämmer / Дрель ударная / Дрель ударный / Útvefúró / Perforator de lovít / Priklerová vrtačka / Priklerová vrtačka / Udarni vrtalnik / Grežtuvas su kalimu / Sítiena urbjmašina / Lökdréll / Бормашина ударна / Udarna bušilica / Udarna bušilica / Кроуотакó брпано / Taladro de impacto / Trapano a percussione / Berbequim de impacto / Perceuse à choc / Slagboormachine

1050W

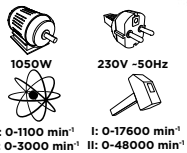

1050W 230V -50Hz I: 0-1100 min⁻¹ II: 0-3000 min⁻¹

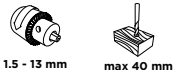

1.5 - 13 mm max 40 mm

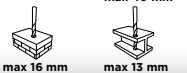

max 16 mm max 13 mm



SKU	[kg]	[]	EAN
586722	5,4	0/4	5902062024251

900W



900W



230V -50Hz



0-2600 min⁻¹



20 mm max 115 mm max 8 mm



SKU	[kg]	[]	EAN
586971	3,1	1/6	5902062015716

Opalarka

Hot air gun / Sengmaschine / Термофен / Фен / Hálégfúvó / Masina de parlit / Opalovací pistole / Opalovacia píšťala / Fen / Techninis ženas / Celniecibas žens / Култронпурх / Писмонет за горещ въздух / Puhala vručeg zraka / Fen / Πιστόλι θερμού αέρα / Descarador por aire caliente / Pistola ad aria calda / Soprador de ar quente / Décapeur thermique / Verfstripper

2000W



2000W



230V -50Hz



I: 300 l/min II: 150 l/min III: 500 l/min



I: 25°C II: 350°C III: 550°C



SKU	[kg]	[]	EAN
596522	1,9	0/5	5902062595225

ELEKTRONARZĘDZIA I AKCESORIA

POWER TOOLS AND ACCESSORIES

ЭЛЕКТРОИНСТРУМЕНТЫ И АККСЕСУАРЫ

10 YEARS SPARE PARTS AVAILABILITY

* Części zamienne dostępne na: gtxservice.pl
* Spare parts available on: gtxservice.pl
* Запасные части на: gtxservice.pl

f @GRAPHITE

▶ GRAPHITEmov

graphite.pl

Odkurzacz warsztatowy

Workshop vacuum cleaner / Werkstattstaubsauger / Пылесос промышленный / Пылесос професиональный / Porszívó / Aspirator atelier cu sistem vacuum / Dilenský vysavač / Dielenský vysávač / Industrijski sesalnik / Промышленна прашосмукачка / Radionički usisivač / Rūpniecības putekļsūcējs / Toöstuslik tolmuimeia / Промышленна прашосмукачка / Radionički usisivač / Industrijski usisivač / Ηλεκτρική ακούνα επαγγελματική / Aspirador / Aspiratore umida/secco / Aspirador de oficina / Aspirateur d'atelier / Werkplaatsstofzuiger

1500W

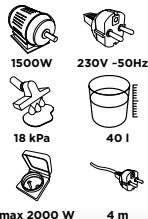

SKU	kg	cm	EAN
596G08	12,3	0/1	5902062024350

Głośnik Bluetooth z funkcją radia

Multimedia speaker / Multimedia-Lautsprecher / Мультимедийная колонка / Мультимедийный динамик / Multimedia hangszóró / Difuzor / Multimedia / Multimediale reproduktor / Multimediaálny reproduktor / Multimediajski zvočnik / Multimediajios garsiakablis / Multimediaj skaurinis / Multimediajtalkālar / Мультимедийна високоговорител / Multimediaalni zvučnik / Multimediajni zvučnik / Ηξίστο πολυμέσων / Altavoz multimedia / Altoparlante multimediale / Altfalante multimedia / Haut-parleur multimedia



4500 mAh



BT FM SD AUX USB MP3 IP65

SKU	kg	cm	EAN
57G100	0,6	0/20	5902062045911

Wiertła do zapieczonych śrub

Seized bolt extractor set / Bohrer zum Lösen festsitzender Schrauben / Сверла для прикипевших болтов / Сверла для прикинувших болтов / Fúrók beégett csavarokhoz / Burghie extractore pentru suruburi ruginite / Vrtáky do zapеченých šroubů / Vrtáky na prehrnuté skrutky / Svedri za zaklenjene vijake / Surúdjúsiú varútz íssuktuvaí / Urbj korodéřám skřevům / Puurid kinnjäänud kruvide eemaldamiskeks / Сверла за спечени ошметов / Svrdla za zaglavljene vijke / Burgie za zarbane zavrtanje / Μύτες εξωλεκής για κατασπαρμένες βίδες / Brocas para tornillos oxidados / Bore do trapano per viti arrugginite / Brocas para parafusos oxidados / Forets pour vis revêtues / Boren voor vastgelopen schroeven

Created by:

NEO TOOLS



Baildon Drills

POLISH DRILLS since 1908

POLSKIE WIERTŁA od 1908 roku

Ø mm	M
3,20	M4
4,20	M5
5,00	M6
6,80	M8
8,50	M10

HEAVY DUTY

Skem

steel

type B

x5



SKU	info	cm	EAN
08-950	krótkie/short/короткие	1/100	5907558452976
08-955	długie/dong/длинные	1/100	5907558452983

Wiertła do metalu

HSS drills / Metallbohrer / Сверла по металлу / Сверла по металлу / Csigafiguró készlet / Burghie pentru metal / Vrtáky do kovu / Vrtáky do kovu / Svedri za kovino / Gražaiti metalui / Urbis metalim / Metallipur / Capăna za mēman / Svrdla za metal / Burģija za metal / Τρυπάνια μέταλλου / Brocas para metal / Set punta a spirale HSS-Tin / Brocas p. metal / Forēts à mētal / Boren voor metal



DIN338

HSS



METAL

Ref.	Ø[mm]	L1	L2	cm	EAN
55H010	2.0	46	24	125/500	5902062997074
55H011	2.2	53	27	125/500	5902062997081
55H013	2.5	57	30	125/500	5902062997104
55H014	3.0	61	33	125/500	5902062997111
55H015	3.2	65	36	125/500	5902062997128
55H016	3.5	70	39	125/500	5902062997135
55H017	3.8	75	43	125/500	5902062997142
55H018	4.0	75	43	125/500	5902062997159
55H019	4.2	75	43	120/480	5902062997166
55H020	4.5	80	47	120/480	5902062997173
55H021	4.8	86	52	120/480	5902062997180
55H022	5.0	86	52	120/480	5902062997197
55H023	5.2	86	52	120/480	5902062997203
55H024	5.5	93	57	120/480	5902062997210
55H025	6.0	93	57	120/480	5902062997227
55H026	6.5	101	63	120/480	5902062997234
55H027	7.0	101	63	75/300	5902062997241
55H028	7.5	101	63	75/300	5902062997258
55H029	8.0	117	75	75/300	5902062997265
55H030	8.5	117	75	75/300	5902062997272
55H031	9.0	125	81	75/300	5902062997289
55H033	10.0	133	87	50/200	5902062997302
55H034	10.2	133	87	50/200	5902062997319
55H035	10.5	133	87	50/200	5902062997326
55H036	11.0	142	94	50/200	5902062997333
55H038	12.0	151	101	50/200	5902062997357
55H039	12.5	151	101	45/180	5902062997364
55H040	13.0	151	101	45/180	5902062997371

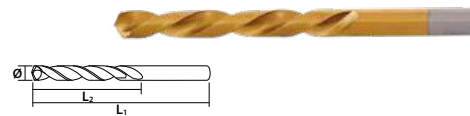

DIN338

HSS TIN



SZLIFOWANA SPIRALA GRINDED FLUTE



METAL



Ref.	Ø [mm]	L1	L2	cm	EAN	
57H110	1.0	5	34	12	20/200	5902062571106
57H112	1.5	5	40	18	20/200	5902062571120
57H114	2.0	5	49	24	20/200	5902062571144
57H116	2.4	3	57	30	20/200	5902062571168
57H118	2.5	3	57	30	20/200	5902062571182
57H120	3.0	1	61	33	20/200	5902062571205
57H121	3.1	1	61	33	20/200	5902062571212
57H122	3.2	1	65	36	20/200	5902062571229
57H123	3.5	1	70	39	20/200	5902062571236
57H124	4.0	1	75	43	20/200	5902062571243
57H126	4.2	1	75	43	20/200	5902062571267
57H128	4.5	1	80	47	20/200	5902062571281
57H130	4.8	1	86	52	20/200	5902062571304
57H132	5.0	1	86	52	20/200	5902062571328
57H134	5.2	1	86	52	20/200	5902062571342
57H136	5.5	1	93	57	20/200	5902062571366
57H138	6.0	1	93	57	20/200	5902062571380
57H140	6.5	1	101	63	20/200	5902062571403
57H142	7.0	1	109	69	20/200	5902062571427
57H144	7.5	1	109	69	20/200	5902062571441
57H146	8.0	1	117	75	20/200	5902062571465
57H148	8.5	1	117	75	20/200	5902062571489
57H150	9.0	1	125	81	20/200	5902062571502
57H152	9.5	1	125	81	20/200	5902062571526
57H154	10.0	1	133	87	20/200	5902062571540
57H156	10.5	1	133	87	20/200	5902062571564
57H158	11.0	1	142	94	20/200	5902062571588
57H162	12.0	1	151	101	20/200	5902062571625
57H164	12.5	1	151	101	20/200	5902062571649
57H166	13.0	1	151	101	20/200	5902062571663

GRAPHITE
POWER IN YOUR HANDS

3 YEARS WARRANTY

3 lata gwarancji na WSZYSTKIE elektronarzędzia, urządzenia, akumulatory i ładowarki marki GRAPHITE. Regulamin dostępny na graphite.pl
3-year warranty on all power tools, devices, batteries and chargers. Terms and conditions are available on en.graphite.pl
Гарантия распространяется на весь электроинструмент GRAPHITE, включая батареи. Подробная информация доступна на сайте ru.graphite.pl

Tarcza tnąca

Cutting disc / Schneidescheibe / Диск пильный / Диск ризальний / Vágókorong / Disc tăietor / Pílový kotouč / Pílový kotuč / Rezina plošča / Pjovino diskas / Ząga disks / Löikeetas / Режец диск / Rezna ploča / Ploče za sečenje / Διάκος κόπης / Disco de corte / Disco da taglio per metallo / Disco cortante / Disque de coupure / Snijnschijven



Ref.	ø1 [mm]	ø2 [mm]	W [mm]	Info	Info			EAN
55H570	115	22	1.0	41 A60-T-BF	INOX (Fe+S+Cl<0.1%)	10	7/28	5902062024374
55H572	125	22	1.0	41 A60-T-BF	INOX (Fe+S+Cl<0.1%)	10	7/28	5902062024381



Ref.	ø1 [mm]	ø2 [mm]	W [mm]	Info	Info			EAN
55H574	115	22	1.0	41 A60-T-BF		10	7/28	5902062024398
55H576	125	22	1.0	41 A60-T-BF		10	7/28	5902062024404

Ściernica listkowa

Flap wheel / Blatt-Schleifscheibe / Листова шліфовальний круг / Круг шліфовальний листовой / Csizolákorong / Disc de rectificat / Brusny kotouč listkový / Brusny lamelový tanier / Brus z lističi / Ślijavimo lapelėliai / Lokšnu slīpēšanas riņķis / Lamell-livhketas / Ламелен диск / Lapezasta brusna ploča / Kolut za brušenje / Τροχός λείωνος με περλίνα / Abanico lijador / Disco lamellare allo zirconio / Disco abrasivo de folhas / Meule abrasive à lamelles / Schuurblad

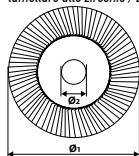

Ref.		Ø1 [mm]	Ø2 [mm]		EAN
57H840	K36	125	22.2	10/100	5902062997012
57H841	K40	125	22.2	10/100	5902062997029
57H842	K60	125	22.2	10/100	5902062997036
57H843	K80	125	22.2	10/100	5902062997043
57H844	K100	125	22.2	10/100	5902062997050
57H845	K120	125	22.2	10/100	5902062997067

Tarcza szlifierska z rzepem

Rubber disc / Schleifscheibe mit Klettverschluss / Круг шліфовальний с липучкой / Круг шліфовальний на липучці / Rugalmas csiszolótaplányér / Disc de cauciu / Leštící kotouč se suchým zipem / Gumový disk stopkový pevný / Brusilna plošča z velcro papirjem / Guminis šlijavimo diskas / Guminijs pamatne slīpiskam / Kummiketas / Диск зумен / Disk gumeni za bušilicu / Gumeni disk / Διάκος λείωνος / Disco elástica con velcro / Disco de gomma / Disco p. esmerilhar / Meule abrasive à adhésif Velcro / Slijpschijf met velcroband



Ref.	ø [mm]		EAN
55H823	125	0/50	5902062502759
55H824	125	0/50	5902062502766



Ref.	ø [mm]		EAN
55H825	125	0/50	5902062502773
55H826	150	0/50	5902062502780



Ref.	ø [mm]		EAN
55H827	125	0/50	5902062502797



Ref.	ø [mm]		EAN
55H928	125	0/50	5902062502803
55H929	150	0/50	5902062502810

GRAPHITE
POWER IN YOUR HANDS



3 lata gwarancji na WSZYSTKIE elektronarzędzia, urządzenia, akumulatory i ładowarki marki GRAPHITE. Regulamin dostępny na graphite.pl
3-year warranty on all power tools, devices, batteries and chargers. Terms and conditions are available on en.graphite.pl
Гарантия распространяется на весь электроинструмент GRAPHITE, включая батареи. Подробная информация доступна на сайте ru.graphite.pl

Krażki ściernie

Abrasive discs / Schleifscheibe / Шлифовальные круги / Круги шлифовальные / Тёрóзáras csiszolópapír / Discuri abrazive / Brúsné kroužky / Brúsné kotúče / Brusne plošče / Šlifavna diskelari / Slipšanas aplī / Lihvrõngad / Абразивни дискове / Brusni kolutiči / Diskovi za brušenje / Δίσκοι λείανσης / Hoja de lija circular / Carta abrasiva / Discos abrasivos / Roulette abrasive / Schurwielen

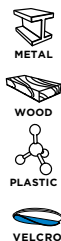

Ref.		Ø [mm]			EAN
55H933	K40	125	5	0/200	5902062502414
55H934	K60	125	5	0/200	5902062502421
55H935	K80	125	5	0/200	5902062502438
55H936	K100	125	5	0/200	5902062502469
55H937	K120	125	5	0/200	5902062502476
55H938	K240	125	5	0/200	5902062502483

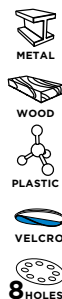

Ref.		Ø [mm]			EAN
55H939	K40	125	5	0/200	5902062502490
55H940	K60	125	5	0/200	5902062502506
55H941	K80	125	5	0/200	5902062502513
55H942	K100	125	5	0/200	5902062502520
55H943	K120	125	5	0/200	5902062502537
55H944	K240	125	5	0/200	5902062502544

Włóknina ścierna

Abrasive cloth / Schleifstoff / Наждачное волокно / Волокно абразивное / Csiszolófilc / Tesztűrű abrazív / Brúsné rouno / Brúsná vlákna / Brusno vlakno / Šlifavna meždiaga / Slipšanas audeklis / Lihvkiud / Абразивна тъкан / Brusna tkanina / Abrazivna tkanina / Υφασμα λείανσης / Tela de lijar / Tessuto abrasivo / Tecido abrasivo / Textile abrasif / Papieren zak



Ref.	Ø [mm]		EAN
55H992	125	5/100	5902062503473



IMPACT PROOF



Ref.	info		EAN
56H555	1/4" HEX -> 1/4" [O]	50/100	5902062504784
56H556	1/4" HEX -> 1/2" [O]	50/100	5902062504791

Brzeszczytoby bagietowe

Sabre saw blade / Bajonett-Sägenblatt / Полотна пильны с точным зубом / Orrfűrészlap / Panze baioneta / Mečové pilové listy / Mečové pilové listy / Bajonetni žigni listi / Bimetalliniai pjūklukai / Asmens zabenžagim / Tåk-saelehed / Сменяемы ленты за трюхи / Bajonet listovi pile / Острице ножа / Πριονόχαφες / Hojas de sable / Lame per sega a gattuccio / Láminas / Lames de scie à baionnette / Sabel mesbladen

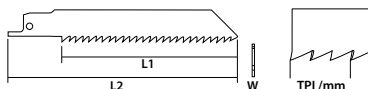

Ref.	Ø1 [mm]	Ø2 [mm]	W [mm]	TPI / mm			EAN	
57H947	230	250	20	0.9	10 / 2.5	2	0/100	5902062579478
57H948	280	300	20	0.9	14 / 1.8	2	0/1	5902062579485
57H950	130	150	20	0.9	10-14 / 2.5-1.8	2	0/150	5902062579508
57H951	130	150	20	0.9	14 / 1.8	2	0/1	5902062579515
57H952	205	225	20	0.9	14 / 1.8	2	0/150	5902062579522
57H953	205	225	20	0.9	18 / 1.4	2	0/100	5902062579539
57H954	205	225	20	0.9	6 / 4.0	2	0/1	5902062579546



IMPACT PROOF



MAGNETIC



Ref.	info		EAN
56H554	60 mm, S2, 1/4"	50/100	5902062504777

ELEKTRONARZĘDZIA I AKCESORIA

POWER TOOLS AND ACCESSORIES

ЭЛЕКТРОИНСТРУМЕНТЫ И АККСЕСУАРЫ

10 YEARS SPARE PARTS AVAILABILITY

* Części zamienne dostępne na: gtxservice.pl
* Spare parts available on: gtxservice.pl
* Запасные части на: gtxservice.pl

f @GRAPHITE

▶ GRAPHITEmov

graphite.pl

Bity udarowe

Impact bits / Schlag-Bits / Ударные вставки / Биту ударни / Ütvecsavarozó bitek / Bit de impact / Úderové bity / Nárazové bity / Udarni biti / Smūginiai antgaliai / Triecienuzgaļi / Löökmeisid / Ударну бумосе / Udarni bitovi / Udarni bitovi / Κρουστικές μύτες / Bits de impacto / Inserti a percussione / Pontas de percussão / Embouts à choc / Slagbits



Ref.	info	box	EAN
56H500	PH1 x 25 mm, x2	50/100	5902062504364
56H501	PH2 x 25 mm, x2	50/100	5902062504371
56H502	PH3 x 25 mm, x2	50/100	5902062504388



Ref.	info	box	EAN
56H518	PH1 x 50 mm, x2	50/100	5902062504524
56H519	PH2 x 50 mm, x2	50/100	5902062504531
56H520	PH3 x 50 mm, x2	50/100	5902062504548



Ref.	info	box	EAN
56H543	PH1/2/3 x 50 mm, x3	50/100	5902062504722



Ref.	info	box	EAN
56H512	TX15 x 25 mm, x2	50/100	5902062504456
56H513	TX20 x 25 mm, x2	50/100	5902062504463
56H514	TX25 x 25 mm, x2	50/100	5902062504470
56H515	TX27 x 25 mm, x2	50/100	5902062504494
56H516	TX30 x 25 mm, x2	50/100	5902062504500
56H517	TX40 x 25 mm, x2	50/100	5902062504517



Ref.	info	box	EAN
56H524	TX15 x 50 mm, x2	50/100	5902062504586
56H525	TX20 x 50 mm, x2	50/100	5902062504593
56H526	TX25 x 50 mm, x2	50/100	5902062504623
56H527	TX27 x 50 mm, x2	50/100	5902062504647
56H528	TX30 x 50 mm, x2	50/100	5902062504661
56H529	TX40 x 50 mm, x2	50/100	5902062504685



Ref.	info	box	EAN
56H503	PZ1 x 25 mm, x2	50/100	5902062504395
56H504	PZ2 x 25 mm, x2	50/100	5902062504401
56H505	PZ3 x 25 mm, x2	50/100	5902062504418
56H506	PZ4 x 25 mm, x2	50/100	5902062504425



Ref.	info	box	EAN
56H521	PZ1 x 50 mm, x2	50/100	5902062504555
56H522	PZ2 x 50 mm, x2	50/100	5902062504562
56H523	PZ3 x 50 mm, x2	50/100	5902062504579



Ref.	info	box	EAN
56H542	PZ1/2/3 x 50 mm, x3	50/100	5902062504715

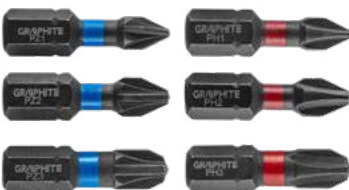

Ref.	info	box	EAN
56H540	PH1/2/3, PZ1/2/3 x 25 mm, x6	50/100	5902062504692



Ref.	info	box	EAN
56H541	TX10/15/20/25/30/40 x 25 mm, x6	50/100	5902062504708

GRAPHITE
POWER IN YOUR HANDS



3 lata gwarancji na WSZYSTKIE elektronarzędzia, urządzenia, akumulatory i ładowarki marki GRAPHITE. Regulamin dostępny na graphite.pl
3-year warranty on all power tools, devices, batteries and chargers. Terms and conditions are available on en.graphite.pl
Гарантия распространяется на весь электроинструмент GRAPHITE, включая батареи. Подробная информация доступна на сайте ru.graphite.pl

Bity udarowe

Impact bits / Schlag-Bits / Ударные вставки / Биту удари / Ütvecsavarozó bitek / Bit de impact / Úderové bity / Nárazové bity / Udarni biti / Smúginiang antgali / Triecienuzgaži / Löökmeistid / Ударну битуе / Udarni bitovi / Udarni bitovi / Κρουστικής μύτες / Bits de impacto / Inserti a percussione / Pontas de percussão / Embouts à choc / Slagbits



Ref.	info	📦	EAN
56H510	SL5.5 x 25 mm, x2	50/100	5902062504432
56H511	SL6.5 x 25 mm, x2	50/100	5902062504449



Ref.	info	📦	EAN
56H507	HEX4 x 25 mm, x2	50/100	5902062504333
56H508	HEX5 x 25 mm, x2	50/100	5902062504340
56H509	HEX6 x 25 mm, x2	50/100	5902062504357



Ref.	info	📦	EAN
56H530	PH1 x 25 mm, x20	10/100	5902062504821
56H531	PH2 x 25 mm, x20	10/100	5902062504838
56H532	PH3 x 25 mm, x20	10/100	5902062504845



Ref.	info	📦	EAN
56H533	PZ1 x 25 mm, x20	10/100	5902062504852
56H534	PZ2 x 25 mm, x20	10/100	5902062504869
56H535	PZ3 x 25 mm, x20	10/100	5902062504876
56H536	PZ4 x 25 mm, x20	10/100	5902062504883

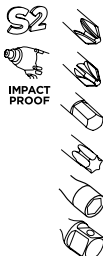

Ref.	info	📦	EAN
56H560	16 x PH1/2/2/2/3, PZ1/2/2/3, TX10/15/20/25/27/30/40 - 25 mm, 14 x PH1/2/2/2/3, PZ1/2/2/2/3, HEX3/4/5/6 - 50 mm, 3 x 6, 8, 10 mm - 48 mm, 1 x 90 mm, 2 x adapter 1/4", 1/2" - 50 mm, S2, 1/4", x36	0/10	5902062504807



Ref.	info	📦	EAN
56H562	PH1/2/3, PZ1/2/3, TX25/27/30/40, 50 mm S2, 1/4", x10	20/80	5902062504814



NEO TOOLS



Ref.	info	📦	EAN
09-575	50 mm, PH1 - x5	12/96	5907558450548
09-576	50 mm, PH2 - x5	12/96	5907558450549
09-577	50 mm, PH3 - x5	12/96	5907558450507



NEO TOOLS



Ref.	info	📦	EAN
09-581	50 mm, SL6 - x5	12/96	5907558450545
09-582	50 mm, SL8 - x5	12/96	5907558450552



NEO TOOLS



Ref.	info	📦	EAN
09-578	50 mm, PZ1 - x5	12/96	5907558450514
09-579	50 mm, PZ2 - x5	12/96	5907558450521
09-580	50 mm, PZ3 - x5	12/96	5907558450538



NEO TOOLS



Ref.	info	📦	EAN
09-583	50 mm, T15 - x5	12/96	5907558450569
09-584	50 mm, T20 - x5	12/96	5907558450576
09-585	50 mm, T25 - x5	12/96	5907558450583
09-586	50 mm, T27 - x5	12/96	5907558450590
09-587	50 mm, T30 - x5	12/96	5907558450606
09-588	50 mm, T40 - x5	12/96	5907558450613

ELEKTRONARZĘDZIA I AKCESORIA

POWER TOOLS AND ACCESSORIES

ЭЛЕКТРОИНСТРУМЕНТЫ И АКСЕССУАРЫ

10 YEARS
SPARE PARTS
AVAILABILITY

* Części zamienne dostępne na: gtxservice.pl
* Spare parts available on: gtxservice.pl
* Запасные части на: gtxservice.pl

f @GRAPHITE

▶ GRAPHITEmov

graphite.pl

Spawarka inwertorowa IGBT

Inverter / Inverter-Schweißgerät / Инвертированный сварочный аппарат / Инвертор зварювальний / Hegesztő inverter / Maşină de sudat invertică / Inverterová svářečka / Zvárací inverter / Inverterski varilnik / Invertinis suvirinimo aparatas / Invertētais metināšanas aparāts / Inverter-keevitusaragast / Инвертерни зварювачь апаратом / Invertini aparat za zavarivanje / Invertini zavarivača / Μηχανήμα συγκόλλησης με εναλλασσόμενο ρεύμα / Soldadora inverter / Soldatrice à inverter / Máquina de soldagem de inversão / Poste de soudure inverter / Inverter laspparaat

120A



IP21S



4.6

230V -50Hz kVA



20-120

66 V

Ø 1,6 - 3,2 mm



Ref.	kg	cm³	EAN
56H811	3.0	0/0	5902062046208

160A



IP21S



6.9

230V -50Hz kVA



20-160

66 V

Ø 1,6 - 4,0 mm



Ref.	kg	cm³	EAN
56H812	3.2	0/0	5902062046215

200A



IP21S



8.7

230V -50Hz kVA



20-200

66 V

Ø 1,6 - 5,0 mm



Ref.	kg	cm³	EAN
56H813	3.2	0/0	5902062046222

Elektrody rutylowe

Rutile electrodes / Rutil-Elektroden / Рутлиевые электроды / Електрода рутилова / Elektroda / Electrozi de rutil / Rutilové elektrody / Rutilové elektrody / Rutine elektrode / Elektrodai su rutilo glaistu / Rutila elektrodai / Rutilelektrodid / Рутлиови електроди / Elektrode za zavarivanje / Rutil elektrode / Ηλεκτρόδια ρουτίλου / Electrods de rutilo / Elettrodi rutilici / Eléktrodos especiais / Baguettes rutilés / Rutiel elektroden



Ref.	ø [mm]	L [mm]	m [kg]	cm³	EAN
56H825	2.5	350	5	0/1	5902062007049
56H827	3.25	350	5	0/1	5902062007056
56H829	4.0	400	5	0/1	5902062007063
56H833	1.8	350	1	0/1	5902062050373
56H839	2.0	350	1	0/1	5902062007001
56H830	2.5	350	1	0/1	5902062007018
56H835	3.25	350	1	0/1	5902062007025
56H840	4.0	400	1	0/1	5902062007032



Drut spawalniczy

Welding wire / Schweißdraht / Проволока сварочная / Дрѝт зварювальний / Hegesztő huzal / Sárná de sudat / Drát pro svařování / Spájkovací drát / Varilla žica / Litavimo viela / Metināšanas stieple / Keevitustraat / Ten za zavarovane / Žica za zavarivanje / Žice za zavarivanje / Συρμα συγκόλλησης / Varilla de soldar / Filo per saldare / Arame de solda / Fil de soudure / Lasdraad



Ref.	ø [mm]	kg	cm³	EAN
56H847	0.8 mm	5.0	0/1	5902062007087
56H849	1.0 mm	5.0	0/1	5902062007094

Przyłbica spawalnicza

Welder's helmet / Schweißerschutzhelm / Шлем сварочный / Каска зварювальника / Hegesztősisak autómatus / Casco de sudar / Svářečská maska / Zvárací kšela / Čelada za varilca / Suvirinimo šalmas / Metinājāma maska / Keevituskiiver / Маска за електрокръво / Maska za varioče / Maska za varioče / Κρανίο ρυθωνοκόλλητη / Máscara de soldadura con visera / Visiera per saldatura / Capacete de soldador / Casque de soudeur / Lashelm



MMA MIG CO² TIG PLASMA EN379

Ref.	INFO	kg	cm³	EAN
56H820	DIN11	0,8	0/1	5902062006974
56H822	DIN9-13	0,8	0/1	5902062006981

Regulowany wspornik magnetyczny

Magnetic welding angle / Magnetwinkel für Schweißarbeiten / Магнитный уголок для сварочных работ / Косиць для зварювальних робіт магнітний / Hegesztőmágnes állítható / Cornier magnetic p/t sudari / Magnetický ušlechňik pro svařování / Magnetický zvärací uholník / Magnetni kotnik za varjenje / Magnetinis suvirinimo kampas / Magnētiskais metināšanas stūrens / Magneturkraud keevitusõadeks / Ёзов профил магнитен зварювач / Magnetski kutnik za zavarivanje / Magnetni uglomer za varjenje / Μαγνητική γωνία συγκόλλησης / Escuadra magnética para soldadura / Squadra magnética per saldatura / Canteonera magnética para soldar / Equerre magnétique de soudeur / Magnetisch laswinkelhaak

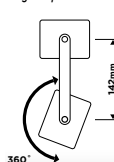

Ref.	kg	cm³	EAN
56H900	1,6	0/1	5902062007261

Spawalniczy kątownik magnetyczny

Magnetic welding angle / Magnetwinkel für Schweißarbeiten / Магнитный уголок для сварочных работ / Косиць для зварювальних робіт магнітний / Hegesztőmágnes állítható / Cornier magnetic p/t sudari / Magnetický ušlechňik pro svařování / Magnetický zvärací uholník / Magnetni kotnik za varjenje / Magnetinis suvirinimo kampas / Magnētiskais metināšanas stūrens / Magneturkraud keevitusõadeks / Ёзов профил магнитен зварювач / Magnetski kutnik za zavarivanje / Magnetni uglomer za varjenje / Μαγνητική γωνία συγκόλλησης / Escuadra magnética para soldadura / Squadra magnética per saldatura / Canteonera magnética para soldar / Equerre magnétique de soudeur / Magnetisch laswinkelhaak



Ref.	kąty / angles / углы	udźwig / capacity / мощность	L x H x W [mm]	cm³	EAN
56H901	45° / 90°	11.4 kg	180 x 112 x 15	0/1	5902062007278
56H902	45° / 90°	22.7 kg	230 x 145 x 20	0/1	5902062007285
56H903	45° / 90°	34.0 kg	237 x 169 x 30	0/1	5902062007292
56H904	45° / 60° / 75° / 90° / 135°	11.4 kg	175 x 110 x 16	0/1	5902062007308
56H905	45° / 60° / 75° / 90° / 135°	34.0 kg	240 x 170 x 28	0/1	5902062007315

GRAPHITE
POWER IN YOUR HANDS



3 lata gwarancji na WSZYSTKIE elektronarzędzia, urządzenia, akumulatory i ładowarki marki GRAPHITE. Regulamin dostępny na graphite.pl
3-year warranty on all power tools, devices, batteries and chargers. Terms and conditions are available on en.graphite.pl
Гарантия распространяется на весь электроинструмент GRAPHITE, включая батареи. Подробная информация доступна на сайте ru.graphite.pl

Spodnie robocze

Working trousers / Arbeitshose / Брюки рабочие / Штаны рабочие / Munkanadrág / Pantaloni de lucru / Pracovní kalhoty / Montérky / Delovne hlače / Darbinės kelinės / Darba bikses / Тööpüksid / Работни панталони / Radne hlače / Radne pantalone / Παντελόνι εργαίας / Pantalón de trabajo / Pantaloni da lavoro / Calças de trabalho / Pantalón de travail



Dodatkowa regulacja rozmiaru w pasie
Additional belt size adjustment
Дополнительная регулировка размера пояса



Uchwyt do narzędzi
Tool holder
Петли для инструмента



Miejsce na wkładki ochronne
Pocket for knee pads
Карманы для вкладышей на колени

Ref.	Size	CE	EAN
81-220-S	S/48	0/10	5907558419085
81-220-M	M/50	0/10	5907558419092
81-220-L	L/52	0/10	5907558419108
81-220-LD	L/54	0/10	5907558419115
81-220-XL	XL/56	0/10	5907558419122
81-220-XXL	XXL/58	0/10	5907558419139

POLYESTER
65%
COTTON
35%

267g/m²

OXFORD
PROTECTOR

3 STRONG

OXFORD
PROTECTOR

OXFORD
PROTECTOR

OXFORD
PROTECTOR

OXFORD
PROTECTOR

OXFORD
PROTECTOR

OXFORD
PROTECTOR

OXFORD
PROTECTOR

OXFORD
PROTECTOR

OXFORD
PROTECTOR

OXFORD
PROTECTOR

OXFORD
PROTECTOR

OXFORD
PROTECTOR

OXFORD
PROTECTOR

OXFORD
PROTECTOR

OXFORD
PROTECTOR

OXFORD
PROTECTOR

OXFORD
PROTECTOR

OXFORD
PROTECTOR

OXFORD
PROTECTOR



Odpinana kieszeń
Detachable pocket
Отстегивающийся карман



Specjalne kieszenie na akcesoria budowlane
np. wkręty
Special pockets for building accessories, for instance screws
Специальные карманы для стройпринадлежностей, например, шурупов



Odpinane nogawki
Detachable legs
Отстегивающиеся брючины



POLYESTER
65%
COTTON
35%

267g/m²

OXFORD
PROTECTOR

3 STRONG

OXFORD
PROTECTOR

OXFORD
PROTECTOR

OXFORD
PROTECTOR

OXFORD
PROTECTOR

OXFORD
PROTECTOR

OXFORD
PROTECTOR

OXFORD
PROTECTOR

OXFORD
PROTECTOR

OXFORD
PROTECTOR

OXFORD
PROTECTOR

OXFORD
PROTECTOR

OXFORD
PROTECTOR

OXFORD
PROTECTOR

OXFORD
PROTECTOR

OXFORD
PROTECTOR

OXFORD
PROTECTOR

OXFORD
PROTECTOR

OXFORD
PROTECTOR

OXFORD
PROTECTOR

Ref.	Size	CE	EAN
81-230-S	S/48	0/10	5907558419146
81-230-M	M/50	0/10	5907558419153
81-230-L	L/52	0/10	5907558419160
81-230-LD	L/54	0/10	5907558419177
81-230-XL	XL/56	0/10	5907558419184
81-230-XXL	XXL/58	0/10	5907558419191



Guma w pasie
Elastic band in waistline
Резинка в поясе



Wielofunkcyjne kieszenie
Multifunctional pockets
Мультифункциональные карманы



Kieszeń na nakolanniki
Pocket for knee pad
Карман для наколенника

Ref.	Size	CE	EAN
81-225-S	S/48	0/20	5907558435146
81-225-M	M/50	0/20	5907558435153
81-225-L	L/52	0/20	5907558435160
81-225-XL	XL/54	0/20	5907558435177
81-225-XXL	XXL/56	0/20	5907558435184

COTTON
100%

275g/m²

3 STRONG

OXFORD
PROTECTOR

OXFORD
PROTECTOR

OXFORD
PROTECTOR

OXFORD
PROTECTOR

OXFORD
PROTECTOR

OXFORD
PROTECTOR

OXFORD
PROTECTOR

OXFORD
PROTECTOR

OXFORD
PROTECTOR

OXFORD
PROTECTOR



Guma w pasie
Elastic band in waistline
Резинка в поясе



Wielofunkcyjne kieszenie
Multifunctional pockets
Мультифункциональные карманы



Miejsce na wkładki ochronne
Pockets from knee pads
Карманы для вкладышей на колени

Ref.	Size	CE	EAN
81-420-S	S/48	0/10	5907558415445
81-420-M	M/50	0/10	5907558415452
81-420-L	L/52	0/10	5907558415469
81-420-LD	L/54	0/10	5907558415476
81-420-XL	XL/56	0/10	5907558415483
81-420-XXL	XXL/58	0/10	5907558415490

POLYESTER
65%
COTTON
35%

245g/m²

OXFORD
PROTECTOR

OXFORD
PROTECTOR

OXFORD
PROTECTOR

OXFORD
PROTECTOR

OXFORD
PROTECTOR

OXFORD
PROTECTOR

OXFORD
PROTECTOR

OXFORD
PROTECTOR

OXFORD
PROTECTOR

OXFORD
PROTECTOR

OXFORD
PROTECTOR

Spodnie robocze

Working trousers / Arbeitshose / Брюки рабочие / Штаны рабочие / Munkanadrág / Pantaloni de lucru / Pracovní kalhoty / Montérky / Delovne hlače / Darbinės kelnės / Darba bikses / Tööpüksid / Работни панталони / Radne hlače / Radne pantalone / Παντελόνι εργαίας / Pantalón de trabajo / Pantaloni da lavoro / Calças de trabalho / Pantalon de travail



Wzmocniony materiał / Reinforced fabric / Усиленная ткань

Wzmocniony materiał na kieszeniach / Reinforced fabric on pockets / Усиленная ткань на карманах

Kieszki na nakolamnik / Pocket for knee pad / Карман для наколенника

Profilowane kolana / Profiled knees / Профилированные колени

COTTON 98% ELASTAN 2%

390g/m²

name

RECYCLED

Ref.	Size	€	EAN
81-228-XS	XS/46	0/20	5907558439427
81-228-S	S/48	0/20	5907558439434
81-228-M	M/50	0/20	5907558439441
81-228-L	L/52	0/20	5907558439458
81-228-XL	XL/54	0/20	5907558439465
81-228-XXL	XXL/56	0/20	5907558439472
81-228-XXXL	XXXL/58	0/20	5907558439489



Guma w pasie / Elastic band in waistline / Резинка в поясе

Kieszenie zapinane na suwak / Zippered pockets / Карманы на молнии

Regulacja obwodu za pomocą stoppera / Adjustable leg hem / Регуляция низа штанин с фиксатором

5000mm

CE

Ref.	Size	€	EAN
81-566-L	S/48	0/20	5907558428186
81-566-M	M/50	0/20	5907558428193
81-566-S	L/52	0/20	5907558428209
81-566-XL	XL/56	0/20	5907558428216
81-566-XXL	XXL/58	0/20	5907558428223
81-566-XXXL	XXXL/60	0/20	5907558428230

Spodnie robocze na szelkach

Working trousers with suspenders / Arbeitslatzhose / Паюкombineзон рабочий / Пюкюombineзон рабочий / Kantáros munkanadrág / Pantaloni de lucru cu bretele / Montérkové kalhoty / Montérky na traky / Delovne hlače z naramnicami / Darbinės kelnės su petnešomis / Darba puskombezonas / Traksidede tööpüksid / Работни панталони с тиранту / Radne farmer hlače / Radne pantalone sa tregerima / Φάρμα εργαίας πνδύτα / Pantalón de trabajo con tirantes / Salopette da lavoro / Jardineiras de trabalho / Pantalon de travail sur bretelles



Kieszki na smartphone'a / Smartphone pocket / Многофункциональные карманы

Wzmocniony materiał na kolanach / Reinforced fabric on knees / Усиления на коленях

Miejsce na wkładki ochronne / Pocket for knee pads / Карманы для вкладышей на колени

Strefy odbłaskowe / Reflective tape / Световозращающие вставки

Dodatkowa regulacja w pasie / Additional belt adjustment / Дополнительная регулировка пояса

Uchwyt na narzędzia / Tool holder / Петли для инструмента

POLYESTER 65% COTTON 35%

267g/m²

OXFORD

STRETCH

POCKET

CE

Ref.	Size	€	EAN
81-240-S	S/48	0/10	5907558419207
81-240-M	M/50	0/10	5907558419214
81-240-L	L/52	0/10	5907558419221
81-240-LD	L/54	0/10	5907558419238
81-240-XL	XL/56	0/10	5907558419245
81-240-XXL	XXL/58	0/10	5907558419252



Szelki / Suspenders / Подтяжки

Wielofunkcyjne kieszenie / Multifunctional pockets / Многофункциональные карманы

Miejsce na wkładki ochronne / Pocket for knee pads / Карманы для вкладышей на колени

Guma w pasie / Elastic band in waistline / Резинка в поясе

POLYESTER 65% COTTON 35%

245g/m²

CE

Ref.	Size	€	EAN
81-430-S	S/48	0/10	5907558415506
81-430-M	M/50	0/10	5907558415513
81-430-L	L/52	0/10	5907558415520
81-430-LD	L/54	0/10	5907558415537
81-430-XL	XL/56	0/10	5907558415544
81-430-XXL	XXL/58	0/10	5907558415551

Spodnie robocze na szelkach

Working trousers with suspenders / Arbeitslatzhose / Полумкомбинезон рабочий / Пюкомбинезон рабочий / Kantáros munkanadrág / Pantaloni de lucru cu bretele / Montérkové kalhoty / Montérky na trávy / Delovne hlače z naramnicami / Darbinės kelės su petnešomis / Darba puskombinizons / Traksidaga tööriksid / Работни панталони с тиранту / Radne farmer hlače / Radne pantalone sa tregerima / Φορμα εργαίας πλάνα / Pantalón de trabajo con tirantes / Salopette da lavoro / Jardineiras de trabalho / Pantalon de travail sur bretelles



COTTON
100%

275g/m²

3

name

CE

Ref.	Size	С	ЕАН
81-245-S	S/48	0/20	5907558435191
81-245-M	M/50	0/20	5907558435207
81-245-L	L/52	0/20	5907558435214
81-245-XL	XL/54	0/20	5907558435221
81-245-XXL	XXL/56	0/20	5907558435238

Bluza robocza

Working top / Arbeitsshirt / Блуза рабочая / Нуртна рабоча / Munkadzseki / Blusa de lucru / Pracovní blůza / Pracovní bunda / Delovna jakna / Darbiniai marškiniai / Darba kreklis / Tööjakk / Работна блуза / Radna blůza / Radna blůza / Μηλούζα εργαίας / Sudadera de trabajo / Giacca da lavoro / Blusa de trabalho / Veste de travail



POLYESTER
65%
COTTON
35%

267g/m²

OXFORD

name

CE

Ref.	Size	С	ЕАН
81-210-S	S/48	0/10	5907558419023
81-210-M	M/50	0/10	5907558419030
81-210-L	L/52	0/10	5907558419047
81-210-LD	L/54	0/10	5907558419054
81-210-XL	XL/56	0/10	5907558419061
81-210-XXL	XXL/58	0/10	5907558419078

Bluza robocza

Working top / Arbeitsshirt / Блуза рабочая / Нуртна рабоча / Munkadzseki / Blusa de lucru / Pracovní blůza / Pracovní bunda / Delovna jakna / Darbiniai marškiniai / Darba kreklis / Tööjakk / Работна блуза / Radna blůza / Radna blůza / Μηλούζα εργαίας / Sudadera de trabajo / Giacca da lavoro / Blusa de trabalho / Veste de travail



COTTON
100%

275g/m²

name

CE

Ref.	Size	С	ЕАН
81-215-S	S/48	0/20	5907558435092
81-215-M	M/50	0/20	5907558435108
81-215-L	L/52	0/20	5907558435115
81-215-XL	XL/54	0/20	5907558435122
81-215-XXL	XXL/56	0/20	5907558435139



245g/m²

POLYESTER
65%
COTTON
35%

name

CE

Ref.	Size	С	ЕАН
81-410-S	S/48	0/10	5907558415384
81-410-M	M/50	0/10	5907558415391
81-410-L	L/52	0/10	5907558415407
81-410-LD	L/54	0/10	5907558415414
81-410-XL	XL/56	0/10	5907558415421
81-410-XXL	XXL/58	0/10	5907558415438

Bluza polarowa

Polar fleece jacket / Arbeitskittel aus Polarfleece / Блуза уз флуца / Маўцсерка / Polár munkadzseki / Bluza polar / Fleeceová mikina / Flísóvá bunda / Jopić iz flísa / Džemperis iš polarinio flíso audinio / Flíša jaka / Fluis / Блуза от фроме / Bluza od polara / Janka / Μηλούζα φλις / Chaqueta de polar / Giacca in pile / Camisola polar / Polo polaire / Fleece trui

Kieszenie zapinane na suwak
Zipped pockets
Карманы на молнии

Wzmocniony materiał na barkach
Reinforced fabric
Усиленный материал на плечах



Profilowany rękaw
Profiled sleeve
Профилированный рукав



Strefy odbłaskowe
Reflective tape
Светоотражающие вставки

Rękaw wykończony elastyczną lamówką
Sleeve finished with elastic binding
Отделка рукава по низу эластичной лентой

Ref.	Size	☞	EAN
81-506-S	S/48	0/13	5907558441505
81-506-M	M/50	0/13	5907558441499
81-506-L	L/52	0/13	5907558434712
81-506-XL	XL/54	0/13	5907558441512
81-506-XXL	XXL/56	0/13	5907558441529
81-506-XXXL	XXXL/58	0/13	5907558441536



Kieszenie zapinane na suwak
Zipped pockets
Карманы на молнии

POLYESTER
100%

300g/m²



Ref.	Size	☞	EAN
81-500-S	S/48	0/20	5907558419498
81-500-M	M/50	0/20	5907558419504
81-500-L	L/52	0/20	5907558419511
81-500-XL	XL/56	0/20	5907558419528
81-500-XXL	XXL/58	0/20	5907558419535

Wzmocniony materiał na łokciach
Reinforced fabric on elbows
Усиленный материал на локтях



Wzmocniony materiał na barkach
Reinforced fabric
Усиленный материал на плечах



Kieszenie zapinane na suwak
Zipped pockets
Карманы на молнии

Ref.	Size	☞	EAN
81-505-S	S/48	0/15	5907558434699
81-505-M	M/50	0/15	5907558434705
81-505-L	L/52	0/15	5907558434712
81-505-XL	XL/54	0/15	5907558434729
81-505-XXL	XXL/56	0/15	5907558434736

POLYESTER
100%

300g/m²



Ref.	Size	☞	EAN
81-501-S	S/48	0/20	5907558429237
81-501-M	M/50	0/20	5907558429244
81-501-L	L/52	0/20	5907558429251
81-501-XL	XL/56	0/20	5907558429268
81-501-XXL	XXL/58	0/20	5907558429275

NEO
TOOLS



BHP OHS CM3

Kurtka robocza

Work jacket / Arbeitsjacke / Куртка рабочая / Куртка робоча / Munkadzseki / Jacheta de lucru / Pracovní bunda / Pracovná bunda / Delovni jopič / Darbinė striukė / Darba jaka / Tööjope / Работное яке / Radna jakna / Radnička jakna / Μπουφάν εργαίας / Chaqueta de trabajo / Giacca da lavoro imbottita / Blusão de trabalho / Veste de travail

Wodoodporny suwak
Water resistant main zipper
Водостойкая главная молния

Kieszonie pod plisą zapinane na suwak
Pockets with zippers under pleat
Карманы под планкой, на молнии

Regulowany obwód rękawa
Adjustable sleeve circumference
Регулируемая окружность рукава

Ref.	Size	☞	EAN
81-558-S	S/48	0/10	5907558434798
81-558-M	M/50	0/10	5907558434804
81-558-L	L/52	0/10	5907558434811
81-558-XL	XL/54	0/10	5907558434828
81-558-XXL	XXL/56	0/10	5907558434835

Zintegrowany kaptur
Integrated hood
Встроенный капюшон

Kieszonie zapinane na suwak
Zippered pockets
Карманы на молнии

Wewnętrzna kieszeń
Inner pocket
Внутренний карман

Ref.	Size	☞	EAN
81-554-S	S/48	0/10	5907558428780
81-554-M	M/50	0/10	5907558428797
81-554-L	L/52	0/10	5907558428803
81-554-XL	XL/56	0/10	5907558428810
81-554-XXL	XXL/58	0/10	5907558428827
81-554-XXXL	XXXL/60	0/10	5907558428834

Kombinezon roboczy

Working overalls / Arbeitsoverall / Кombinezon рабочий / Кombinezon робочий / Overall / Combinezon de lucru / Pracovní kombinéza / Pracovná kombinéza / Delovni kombinezon / Darbinis kombinezonas / Darba kombinezons / Töökombineeson / Работен кombineзон / Radni kombinezon / Radni kombinezon / Форма εργαίας / Mono de trabajo / Tuta da lavoro / Mascacão de trabalho / Combinaison de travail / Werkoverall

Kieszień na smartphone'a
Smartphone pocket
Многофункциональные карманы

Wzmocniony materiał na kolanach
Reinforced fabric on the knees
Усиления на коленях

Miejsce na wkładki ochronne
Pocket for knee pads
Место для защитных вставок

Wielofunkcyjne kieszonie
Multifunctional pockets
Многофункциональные карманы

Ref.	Size	☞	EAN
81-250-S	S/48	0/10	5907558419269
81-250-M	M/50	0/10	5907558419276
81-250-L	L/52	0/10	5907558419283
81-250-LD	L/54	0/10	5907558419290
81-250-XL	XL/56	0/10	5907558419306
81-250-XXL	XXL/58	0/10	5907558419313

Koszulka z długim rękawem

Longsleeve / Langarm-Shirt / Футболка с длинными рукавами / Сорочка з довгим рукавом / Póló / Cămașă cu mânecă lungă / Tričko s dlouhým rukávem / Tričko s dlhým rukávom / Strajca z dolgimi rokavi / Marškiniai su ilgomis rankovėmis / Krekts ar garām piedurknēm / Pikade varguletega sārķ / Блузка с дълъг ръкав / Majica dugih rukava / Košulja sa dugim rukavima / Μπλουζάκι μακρυμάνικα / Camisa de manga larga / Maglietta a manica lunga

81-617

81-616

Ref.	Size	☞	EAN
81-617-S	S/48	0/50	5907558435436
81-617-M	M/50	0/50	5907558435443
81-617-L	L/52	0/50	5907558435450
81-617-XL	XL/54	0/50	5907558435467
81-617-XXL	XXL/56	0/50	5907558435474
81-616-S	S/48	0/50	5907558435290
81-616-M	M/50	0/50	5907558435306
81-616-L	L/52	0/50	5907558435313
81-616-XL	XL/54	0/50	5907558435320
81-616-XXL	XXL/56	0/50	5907558435337

T-shirt

T-shirt / T-Shirt / Футболка сизалъная / Футболка / Póló / T-shirt / Tričko / Tričko / Majica / Apatiniai marškinėliai - T / T-kreklis / T-särk / Тушррм / T-shirt / Majica kratkih rukava / Κοτομάνικη μπλούζα / Camiseta / Maglietta / Camisola / T-shirt / T-shirt



81-610



81-611



Ref.	Size	☞	EAN
81-610-L	S/48	0/50	5907558432046
81-610-M	M/50	0/50	5907558432039
81-610-S	L/52	0/50	5907558432022
81-610-XL	XL/56	0/50	5907558432053
81-610-XXL	XXL/58	0/50	5907558432060
81-611-L	S/48	0/50	5907558432091
81-611-M	M/50	0/50	5907558432084
81-611-S	L/52	0/50	5907558432077
81-611-XL	XL/56	0/50	5907558432107
81-611-XXL	XXL/58	0/50	5907558432114



81-615



81-612



Ref.	Size	☞	EAN
81-615-S	S/48	0/50	5907558435344
81-615-M	M/50	0/50	5907558435351
81-615-L	L/52	0/50	5907558435368
81-615-XL	XL/54	0/50	5907558435375
81-615-XXL	XXL/56	0/50	5907558435382
81-612-S	S/48	0/50	5907558432121
81-612-M	M/50	0/50	5907558432138
81-612-L	L/52	0/50	5907558432145
81-612-XL	XL/54	0/50	5907558432152
81-612-XXL	XXL/56	0/50	5907558432169

Bezrękawnik roboczy

Work body warmer / Arbeitsweste / Жилет рабочий / Безрукавка рабочая / Melegítő munkamellény / Vesta de lucru / Pracovní vesta / Pracovná vesta / Delovni brezrokovnik / Darbinė liemenė / Dobra jaka bez piedurknēm / Төövөст / Работен елек / Radni prsluk / Radnički prsluk / Τίλεκο εργασίας / chaleco de trabajo / Gilet de lavoro invernale / Blusa de trabalho sem mangas / Gilet de travail

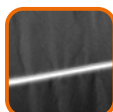

Strefy odbłaskowe
Reflective tape
Световозвращающие вставки



Wewnętrzne kieszenie
Inner pockets
Внутренние карманы



Ref.	Size	☞	EAN
81-530-S	S/48	0/20	5907558427011
81-530-M	M/50	0/20	5907558427028
81-530-L	L/52	0/20	5907558427035
81-530-XL	XL/56	0/20	5907558427042
81-530-XXL	XXL/58	0/20	5907558427059



Strefy odbłaskowe
Reflective tape
Световозвращающие вставки



Kieszenie zapinane na suwak
Zippered pockets
Карманы на молнии



Wewnętrzna kieszeń
Inside pocket
Внутренний карман



Ref.	Size	☞	EAN
81-532-S	S/48	0/20	5907558427882
81-532-M	M/50	0/20	5907558427899
81-532-L	L/52	0/20	5907558427905
81-532-XL	XL/56	0/20	5907558427912
81-532-XXL	XXL/58	0/20	5907558427929
81-532-XXXL	XXXL/60	0/20	5907558427936



Koszula flanelowa

Flannel shirt / Flannelhemd / Фланелевая рубашка / Сорочка фланелева / Flanel ing / Cămașă de flanelă / Flanelová košile / Flanelová košela / Flanelasta srajca / Flaneliniai marškiniai / Flanela kreklis / Flannelsärk / Фланелена риза / Košulja od flanela / Flanelsta košulja / Φανελένο πουκάμισο / Camisa de franela / Camicia di flanela / Camisa de flanela / Chemise en flanelle



COTTON
100%



81-541

Ref.	Size	€	EAN
81-540-S	S/48	0/36	5907558432244
81-540-M	M/50	0/36	5907558432251
81-540-L	L/52	0/36	5907558432268
81-540-XL	XL/54	0/36	5907558432275
81-540-XXL	XXL/56	0/36	5907558432282
81-541-S	S/48	0/36	5907558432299
81-541-M	M/50	0/36	5907558432305
81-541-L	L/52	0/36	5907558432312
81-541-XL	XL/54	0/36	5907558432329
81-541-XXL	XXL/56	0/36	5907558432336

Koszula robocza

Work shirt / Arbeitshemd / Рабочая рубашка / Рбоча сорочка / Munka ing / Cămașă de lucru / Pracovní košile / Pracovní košela / Delovna majica / Darbo marškiniai / Darba kreklis / Töösärk / Работна риза / Radna košulja / Радна мајица / εργασία πουκάμισο / Camisa de trabajo / Camicia da lavoro / Camisa de trabalho / Chemise de travail



Podwójny karczek
Double yoke
Двойное ядро

Wzmocniony materiał
Reinforced fabric
Усиленная ткань

COTTON
100%



Ref.	Size	€	EAN
81-549-S	S/48	0/30	5907558439625
81-549-M	M/50	0/30	5907558439632
81-549-L	L/52	0/30	5907558439649
81-549-XL	XL/54	0/30	5907558439656
81-549-XXL	XXL/56	0/30	5907558439663
81-549-XXXL	XXXL/58	0/30	5907558439670

Koszulka termoaktywna

Thermal long sleeve / Thermo-Funktionsunterwäsche Hemd langarm / Термоактивная блуза / Футболка з довшим рукавом термоактивна / Hosszú ujjú Thermo alátöltöz / Cămașă termoactivă / Termoaktivní tričko / Termo tričko / Termo majica / Termo marškinėliai / Termovelas kreklis / Termoaktivne alussärk / Термоактивна блуза / Термоактивна майица / Термоактивна кошулја / Ιαθερμική μπλούζα / Camiseta termoactiva / Maglia termica / Camisola térmica / Chemise thermoactive / Thermoactive shirt



POLYAMIDE
63%
POLYESTER
32%
ELASTANE
5%



Ref.	Size	€	EAN
81-660-S/M	S/M	0/60	5907558431964
81-660-L/XL	L/XL	0/60	5907558431971
81-660-XXL/XXXL	XXL/XXXL	0/60	5907558431988

Kalesony termoaktywne

Thermal leggings / Thermo-Funktionsunterwäsche Hose / Термоактивные калесоны / Калесони термоактивни / Melegítőnadrág Thermo alátöltöz / Izmene thermoactive / Termoaktivni kalhoty (spodky) / Termo spodné nohavice / Termo spodnje blaiče / Termo kelens / Termovelas bikses / Termoaktivsed pikad aluspüksid / Термоактивни илун / Термоактивне дуге гаће / Termoaktivne pantalone / Ιαθερμική κολλάβ / Mallas termoactivas / Calzamalga termica / Calças justas térmicas / Caleçon thermoactif / Thermoactive broek



POLYAMIDE
63%
POLYESTER
32%
ELASTANE
5%



Ref.	Size	€	EAN
81-670-S/M	S/M	0/60	5907558431995
81-670-L/XL	L/XL	0/60	5907558432008
81-670-XXL/XXXL	XXL/XXXL	0/60	5907558432015

Koszulka polo

Polo shirt / Polo-Shirt / Футболка-поло / Сорочка-поло / Pólóing / Camisa din tesatura sintetica fleece / Tričko polo / Polokošela / Majica z ovratnikom / "Marškiniai „Polo“" / Polo kreklis / Polosärk / Блуза полф / Polo majica / Polo majica / Ковтањинки μπλούζα πόλο / Camiseta polo / Polo / Camisa pólo / Chemise polo / Polo shirt



COTTON
100%



196g/m²



Ref.	Size	€	EAN
81-606-S	S/48	0/40	5907558439809
81-606-M	M/50	0/40	5907558439816
81-606-L	L/52	0/40	5907558439823
81-606-XL	XL/54	0/40	5907558439840
81-606-XXL	XXL/56	0/40	5907558439847
81-606-XXXL	XXXL/58	0/40	5907558439854

NEO
TOOLS



BHP OHS CM3

Póftbuty robocze

Safety shoes / Arbeitshalschuhe / Поуботинки робочие / Пичеревани работчи / Munkaciső / Pantofi de lucru / Pracovní obuv / Pracovné poltopánky / Nizki delovni čevlji / Darbo pusbačiai / Darba puszabaki / Töökingad / Работни обувки ниски (половинки) / Radne cipele / Poluduboke radne cipele / Низијната ервајас / Botas de seguridad / Scarpa da lavoro / Sapatos de trabalho / Souliers de sécurité / Werkschoenen



Ref.	Size	☞	EAN
82-010	39	0/10	5907558412604
82-011	40	0/10	5907558414530
82-012	41	0/10	5907558414974
82-013	42	0/10	5907558414981
82-014	43	0/10	5907558414998
82-015	44	0/10	5907558415001
82-016	45	0/10	5907558415018
82-017	46	0/10	5907558415025
82-018	47	0/10	5907558421002



Ref.	Size	☞	EAN
82-155-39	39	0/10	5907558442908
82-155-40	40	0/10	5907558442915
82-155-41	41	0/10	5907558442922
82-155-42	42	0/10	5907558442939
82-155-43	43	0/10	5907558442946
82-155-44	44	0/10	5907558442953
82-155-45	45	0/10	5907558442960
82-155-46	46	0/10	5907558442977
82-155-47	47	0/10	5907558442984



Ref.	Size	☞	EAN
82-100	39	0/10	5907558426830
82-101	40	0/10	5907558426847
82-102	41	0/10	5907558426854
82-103	42	0/10	5907558426861
82-104	43	0/10	5907558426878
82-105	44	0/10	5907558426885
82-106	45	0/10	5907558426892
82-107	46	0/10	5907558426908
82-108	47	0/10	5907558426915



Ref.	Size	☞	EAN
82-110	39	0/10	5907558426922
82-111	40	0/10	5907558426939
82-112	41	0/10	5907558426946
82-113	42	0/10	5907558426953
82-114	43	0/10	5907558426960
82-115	44	0/10	5907558426977
82-116	45	0/10	5907558426984
82-117	46	0/10	5907558426991
82-118	47	0/10	5907558427004



Ref.	Size	☞	EAN
82-700	39	0/10	5907558430073
82-701	40	0/10	5907558430080
82-702	41	0/10	5907558430097
82-703	42	0/10	5907558430103
82-704	43	0/10	5907558430110
82-705	44	0/10	5907558430127
82-706	45	0/10	5907558430134
82-707	46	0/10	5907558430141
82-708	47	0/10	5907558430158



Ref.	Size	☞	EAN
82-710	39	0/10	5907558430165
82-711	40	0/10	5907558430172
82-712	41	0/10	5907558430189
82-713	42	0/10	5907558430196
82-714	43	0/10	5907558430202
82-715	44	0/10	5907558430219
82-716	45	0/10	5907558430226
82-717	46	0/10	5907558430233
82-718	47	0/10	5907558430240

Sandaty robocze

Working sandals / Arbeitssandale / Рабочие сандалии / Sandale de lucru / Рабочи стандарти / Munkaszandál / Pracovní sandály / Pracovné sandále / Delovni sandali / Darbo sandalai / Darba sandales / Тöösandaalid / Работни сандали / Radne sandale / Radne sandale / Σανδάλια εργαίας / Sandalias de trabajo / Sandali da lavoro / Sandálias de proteção / Sandales de travail / Werksandalen



Ref.	Size	☞	EAN
82-070-36	36	0/10	5907558440782
82-070-37	37	0/10	5907558440799
82-070-38	38	0/10	5907558440805
82-070-39	39	0/10	5907558440812
82-070-40	40	0/10	5907558440829
82-070-41	41	0/10	5907558440836
82-070-42	42	0/10	5907558440843
82-070-43	43	0/10	5907558440850
82-070-44	44	0/10	5907558440867
82-070-45	45	0/10	5907558440874
82-070-46	46	0/10	5907558440881
82-070-47	47	0/10	5907558440898



Ref.	Size	☞	EAN
82-720	39	0/10	5907558430257
82-721	40	0/10	5907558430264
82-722	41	0/10	5907558430271
82-723	42	0/10	5907558430288
82-724	43	0/10	5907558430295
82-725	44	0/10	5907558430301
82-726	45	0/10	5907558430318
82-727	46	0/10	5907558430325
82-728	47	0/10	5907558430332



Trzewiki robocze

Safety boots / Arbeitsschuhe / Ботинки рабочие / Чревени работчи / Munkabakancs / Boscanci de lucru / Kotníková pracovní obuv / Pracovné topánky / Visoki delovni čevlji / Darbo batai / Darba zăbaki / Тöösaapad / Работни обувки високи / Radne visoke cipele / Radne cipele / Μπαστάκια εργαίας / Botas de seguridad altas / Scarpa alta da lavoro / Botas de trabalho / Chaussures de sécurité / Hoge werkschoenen



Ref.	Size	☞	EAN
82-020	39	0/10	5907558415032
82-021	40	0/10	5907558415049
82-022	41	0/10	5907558415056
82-023	42	0/10	5907558415063
82-024	43	0/10	5907558415070
82-025	44	0/10	5907558415087
82-026	45	0/10	5907558415094
82-027	46	0/10	5907558415100
82-028	47	0/10	5907558421019



Ref.	Size	☞	EAN
82-120	39	0/10	5907558428698
82-121	40	0/10	5907558428704
82-122	41	0/10	5907558428711
82-123	42	0/10	5907558428728
82-124	43	0/10	5907558428735
82-125	44	0/10	5907558428742
82-126	45	0/10	5907558428759
82-127	46	0/10	5907558428766
82-128	47	0/10	5907558428773



Wkładki do butów

Shoe insert / Einlegesohle / Стелка для обуви / Устінка до черевіків / Talpbetét / Brant de ĩncălțăminte / Vložka do obuvi / Vložka do topánok / Vložek za čevlji / Batų vidpadis / Aparu ieliktnis / Sisetallad / Вложка за обувку / Uložak za cipele / Uložak za obuću / Πάτος παπουτσιών / Plantilla para zapatos / Soletta, taglia unica / Palmilha / Insert de chaussure / Inlegzok



rozmiar uniwersalny – do docięcia
komfort i świeżość przez 30 dni
universal size – for trimming
comfortable and fresh for 30 days
универсальный размер – для подрезки
комфорт и свежесть в течение 30 дней

Ref.	N	☞	EAN
82-300	x1	0/300	5907558428568
82-301	x10	0/30	5907558428544



rozmiar uniwersalny – do docięcia
wkładka z węglem aktywnym – komfort i świeżość przez 30 dni
universal size – for trimming
insert with activated carbon – comfortable and fresh for 30 days
универсальный размер – для подрезки
стелька с активированным углем – комфорт
и свежесть в течение 30 дней

Ref.	N	☞	EAN
82-302	x1	0/300	5907558431445
82-303	x10	0/30	5907558431421



NEO
TOOLS



BHP OHS CM3

Wkładki do butów

Shoe insert / Einlegesohle / Стелька для обуви / Устінка до черевука / Talpbetét / Brant de încălțăminte / Vložka do obuvi / Vložka do topánok / Vložek za čevlje / Batų vidpadis / Араву велітніс / Sisetalad / Вложка за обуку / Uložak za cipele / Uložak za obuću / Πλάτος παπουτσιών / Plantilla para zapatos / Soletta, taglia unica / Palmilha / Insert de chaussure / Inlegzool



Ref.	Size	☞	EAN
82-310	38-39	0/200	5907558430523
82-311	40-41	0/200	5907558430530
82-312	42-43	0/200	5907558430547
82-313	44-45	0/200	5907558430554
82-314	46-47	0/200	5907558430561



Ref.	Size	☞	EAN
82-320	38-39	0/200	5907558430578
82-321	40-41	0/200	5907558430585
82-322	42-43	0/200	5907558430592
82-323	44-45	0/200	5907558430608
82-324	46-47	0/200	5907558430615

Rękawice robocze

Working gloves / Arbeitshandschuhe / Перчатки рабочие / Руквици работчи / Munkakesztyű / Mänuși de lucru / Pracovní rukavice / Pracovné rukavice / Delovne rokavice / Darbo pirštinės / Darba cimdi / Töökindad / Ръкавици работни / Radne rukavice / Radne rukavice / Γάντια εργατικά / Guantes de trabajo / Guanti da lavoro / Luvas de trabalho / Gants de travail / Werkhandschoenen



Ref.	Size	☞	EAN
97-609-8	8"	10/100	5907558447965
97-609-9	9"	10/100	5907558447934
97-609-10	10"	10/100	5907558447941



Ref.	Size	☞	EAN
97-615	10"	12/120	5907558433982



Ref.	Size	☞	EAN
97-610-8	8"	10/100	5907558448054
97-610-9	9"	10/100	5907558448061
97-610-10	10"	10/100	5907558448078



Ref.	Size	☞	EAN
97-616-8	8"	10/100	5907558447996
97-616-9	9"	10/100	5907558448009
97-616-10	10"	10/100	5907558448016



Ref.	Size	☞	EAN
97-620-8	8"	10/300	5907558448054
97-620-9	9"	10/300	5907558448061
97-620-10	10"	10/300	5907558448078



Ref.	Size	☞	EAN
97-617-8	8"	10/100	5907558448023
97-617-9	9"	10/100	5907558448030
97-617-10	10"	10/100	5907558448047

Rękawice robocze

Working gloves / Arbeitshandschuhe / Перчатки рабочие / Руквици работчи / Munkakesztyű / Máuşni de lucru / Pracovní rukavice / Pracovné rukavice / Delovne rokavice / Darbo pirštines / Darba cimdi / Töökindad / Ръкавици работни / Radne rukavice / Radna rukavice / Гάντια εργασιών / Guantes de trabajo / Guanti da lavoro / Luvas de trabalho / Gants de treball / Werkhandschoenen



NITRILE
COATED

KAT II

CE

Ref.	Size	☞	EAN
97-621-8	8"	10/100	5907558448085
97-621-9	9"	10/100	5907558448092
97-621-10	10"	10/100	5907558448108



NITRILE
COATED

KAT II

CE

Ref.	Size	☞	EAN
97-630-8	8"	10/100	5907558448139
97-630-9	9"	10/100	5907558448115
97-630-10	10"	10/100	5907558448122



NITRILE
COATED

KAT II

CE

Ref.	Size	☞	EAN
97-631-8	8"	10/100	5907558448146
97-631-9	9"	10/100	5907558448153
97-631-10	10"	10/100	5907558448160



LATEX
COATED

KAT II

CE

Ref.	Size	☞	EAN
97-640-8	8"	10/100	5907558447811
97-640-9	9"	10/100	5907558447828
97-640-10	10"	10/100	5907558447835



LATEX
COATED

KAT II

CE

Ref.	Size	☞	EAN
97-641-8	8"	10/100	5907558447842
97-641-9	9"	10/100	5907558447859
97-641-10	10"	10/100	5907558447866



NITRILE
COATED

KAT II

CE

Ref.	Size	☞	EAN
97-642-8	8"	10/100	5907558447897
97-642-9	9"	10/100	5907558447873
97-642-10	10"	10/100	5907558447880



2xLATEX
COATED

KAT II

CE

Ref.	Size	☞	EAN
97-643-8	8"	10/100	5907558447903
97-643-9	9"	10/100	5907558447910
97-643-10	10"	10/100	5907558447927



10"

fluorescent

KAT II

1242

CE

Ref.	Size	☞	EAN
97-611	10"	0/120	5907558421804

NEO
TOOLS



BHP OHS CM3

Rękawice robocze

Working gloves / Arbeitshandschuhe / Перчатки рабочие / Руквици работчи / Munkakesztyű / Máuusi de lucru / Pracovní rukavice / Pracovné rukavice / Delovne rokavice / Darbo pirštines / Darba cimdi / Töökindad / Ръкавици работни / Radne rukavice / Γάντια εργασις / Guantes de trabajo / Guanti da lavoro / Luvas de trabalho / Gants de travail / Werkhandschoenen



Ref.	Size	☞	EAN
97-605	10"	0/96	5907558412901



Ref.	Size	☞	EAN
97-603	10"	12/120	5907558409147
97-604	8"	0/120	5907558407655



Ref.	Size	☞	EAN
97-602	10,5"	12/96	5907558406825



Ref.	Size	☞	EAN
97-606	10"	6/96	5907558412918

Półmaska przeciwpyłowa

Dust half-mask / Stauschutzmaske / Песниратор противопылевой / Песниратор захисний протикульовий / Pormaszok aktiv szénnel / Polomaska protiprašná / Respirátor protiprachový / Zaščitna maska / Puskauke nuo dulkių / Aizsargmaska / Tolmuvastane poolmask / Маска противопыльная / Zaštitna maska / Zastitna maska / Ημιμασκα προσιών προστασίας από σκόνη / Máscara para polvo / Maschera di protezione / Máscara contra pó / Demi-masque anti-poussière / Stof half-masker



Ref.	☞	EAN
97-300	10/120	5907558407686

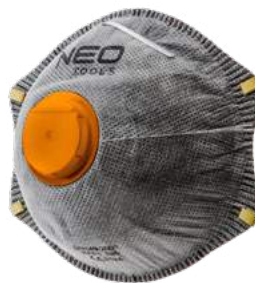

Ref.	☞	EAN
97-301	10/120	5907558407693



Ref.	☞	EAN
97-311	10/100	5907558407723



Ref.	☞	EAN
97-321	10/80	5907558421811

Pótmaska silikonowa

Silicon mask / Silikon-Halbmaste / Силиконовая полумаска / Пółмаска silikonowa / Szilikon félmaszk / Semimásca cu silicon / Silikonová polomaska / Silikonový respirátor / Silikoniska polmaska / Silikonine puskaüké / Silikona pusmaska / Silikonist respirator / Силиконова полумаска / Silikoniska polumaska / Silikoniska polumaska / Μάσκα μισού προσώπου από σιλίκων / Media máscarilla de silicona / Maschera di protezione / Semi-máscara em silicone / Demi-masque silicone



Ref.	☞	EAN
97-350	0/60	5907558407730

Filter

Filter / Filter / Филтър / Филтър / Szűrő, por és kis részecskék elleni védelem / Filtru / Filtr / Filter / Filter / Filtras / Filtras / Filter / Филтър / Filter / Filtri za prašinu / Φίλτρο / Filtra / Filtra per mascherina / Filtru / Filtr / Filter



ochrona przed pyłem i cząstkami drobnymi
protection against dust and small particles
защита от пыли и мелких частиц

Ref.	☞	EAN
97-361	0/200	5907558408058

Pochłaniacz

Cartridge / Maskenfilter / Фильтрующий патрон / Филтър / Szűrő, szerves gázok ellen / Absorbent / Pohlčovač / Pohlčovač / Absorbent / Filtras / Absorbētājs / Filter / Аδсорбер / Apsorber / Prigušivač / Αναλκτικό φίλτρο A1 / Filtra / Cartuccia / Filtra / Absorbeur



ochrona przed oparami organicznymi
protection against organic vapours
защита от паров органических веществ

Ref.	☞	EAN
97-360	0/200	5907558407747



ochrona przed gazami organicznymi,
nieorganicznymi, kwasowymi i gazami amoniaku
protection against organic, non-organic, acid and ammonia gases
защита от органических, неорганических, кислотных газов, аммиака и его производных

Ref.	☞	EAN
97-362	0/200	5907558409130

Okulary ochronne

Safety goggles / Schutzbrille / Очки защитные / Окуляри протиоскопні / Szemüveg / Očelari protecție / Ochranné brýle / Ochranné okuliare / Zaščitna očala / Apsaugojiniai akiniai / Aizsargbrilles / Kaitseprillid / Очла предпазни / Zaštitne naočale / Zastitne naočari / Γυαλιά προστασίας / Gafas protectoras / Očchiali di protezione / Óculos de proteção / Lunettes de protection / Beschermingsbril



97-500

97-501

Ref.	☞	EAN
97-500	6/72	5907558407747
97-501	6/72	5907558406894



Ref.	☞	EAN
97-510	12/300	5907558443970

NEO
TOOLS



BHP OHS CM3

Gogle ochrone

Protective goggles / Augenschutzbrillen / Защитные очки / Окуляри захисні / Védőszemüveg / Ochelari de protecție / Ochranné brýle / Ochranné okuliare / Zaščitna očala / Apsauginiai akiniai / Aizsargbrilles / Kaitseprillid / Защитные очки / Zaštitne gogle / Zaštitne naočare / Προστατευτικά γυαλιά / Gafas protectoras / Occhiali protettivi / Oculos de protecção / Lunettes google de protection / Veiligheidsbril



ANTI
FOG

optical
class 1

B₁20
m/s



Ref.	♣	EAN
97-513	10/60	5907558443752

Wkładki piankowe na kolana

Knee foam pads / Knieeinlagen aus Schaumstoff / Вставки-наполненники из пеноматериала / Наколінники поліуретанові / Hab térdelőbéllet / Inserti de spuma pentru genunchi / Pěnové vložky kolen / Penové vložky na kolena / Penasti ščitniki za kolena / Apsauga keliams su putų pagalvėlemis / Putuplasta ieliktni celgaliam / Vahtplastist pälvekaitsmed / Наколеници от пяна / Пренasti štitnik za koleno / Jastučici od pene za kolena / Προσθαλαφαιρούμενες επιγονατίδες από αφρώδες υλικό / Rodilleras de espuma / Ginocchiere in schiuma / Almofada de espuma para joelho / Inserts de protection en mousse pour genoux / Dordopjes

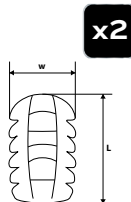

x2

Ref.	W [mm]	L [mm]	♣	EAN
97-530	175	265	0/25	5907558419610

Nakolanniki ochrone

Knee protector / Knieeschützer / Щитки-наполненники / Щитки на колінні захисні / Térdvédő / Genuechieră protectoare / Nákolenky / Chránič kolien / Ščitniki za kolena / Apsauga keliams / Celgala aizsargi / Pälvekaitse / Наколеник / Šitnik za koljena / Šitnik za kolena / Επιγονατίδες προστατευτικές / Rodilleras de protección / Ginocchiere popolari / Proteção de joelhos / Protège-genoux / Kniebescherming



x2



Ref.	♣	EAN
97-536	6/24	5907558407679



x2



Ref.	♣	EAN
97-535	6/24	5907558419627

Wkładki przeciwhałasowe

Earplugs / Ohrstöpsel / Протишумні вкладкиши / берушки ("берушки") / Fuldugó / Antifonaie / zátky do uší / Zátkové chrániče sluchu / Čerpi za ušesa / Ausų kaitštukai / Ausu aizbāžņi / Kōvatropid / Антифони, поставяни на ушете / Čerpi za uši / Čerovi za uši / Προσπίδες / Tapones para los oídos / Tappi per le orecchie / Tampões de ouvidos / Bouchons d'oreille / Inzetdelen voor schroefdraad herstel



x10

EN352



Ref.	W [mm]	L [mm]	♣	EAN
97-550	9/11	33dB	0/500	5907558419634
97-555	5/16	29dB	2/1040	5907558419641

Pas

Belt / Riemen / Пояс / Pas / Szerszámtartóöv / Bandă / Pásek / Opasok montérsky / Pas / Diržas / Siksna / Lint / Колан за кољџу / Pojas za torbu za alat / Pojas / Závň / Cinturón para pistoleras y bolsas de herramientas / Cintura per montatore / Cinto / Ceinture / Riem



COTTON
100%

ONE
SIZE

130
cm

Ref.	L [cm]	♣	EAN
81-900	130 cm	0/160	5907558431148

Czapka z latarką

Cap with flashlight / Mütze mit Stirnlampe / Шапка с фонариком / Шапка з ліхтарем / Sarpka lámpával / Čaciulă cu lanternă / Čerpe s baterkou / Čiapka s baterkou / Kapa za lučku / Kerpe su žibintuvěliu / Čepure ar lukturi / Lambiga miits / Шапка с фенерче / Kapa sa svjetiljkom / Kapa s lampom / Καπέλο τύπου τζέικεϋ με φακό / Gorra con linterna / Cappello con torcia elettrica / Gorro com lanterna / Casquette avec torche / Set van gatenzagen



Ref.	♣	EAN
81-621	12/120	5907558428308

Czapka z daszkiem

Work cap / Schildmütze / Бейсболка рабочая / Бейсболка рабоча / Munkaruha baseball sapka / Sarpca cu cozoroc / Pracovní kšiltovka / Čiapka so šiltom, pracovná / Delovna kapa s šiltom / Kerpe su snapelju / Darba čepure ar pagu / Nokađa tōōmūts / Работна шапка с козурка / Radna kapa / Radnička kapa / Καπέλο εργασίας τύπου μπέϊζμπολ / Gorra de trabajo / Berretto da lavoro / Boné de trabalho / Casquette de travail à visière



100%
COTTON



Ref.	♣	EAN
97-590	0/50	5907558415728

Olej uniwersalny

Universal oil / Universālāļ / Универсальное масло / Универсальна олива / Universzális olaj / Ulei universal / Univerzální olej / Univerzálny olej / Univerzalno olje / Univeršali alyva / Univeršāla eļļa / Univeršaalne õli / Univeršalno masno / Univerzalno ulje / Univerzalno ulje / Λόβι γενικής χρήσης / Aceite universal / Oleo universale / Oleo universal / Huile universelle / Universeele olie



Ref.	info	📦	EAN
09 096 924	200 ml	1/12	4103810420962



Ref.	info	📦	EAN
10 597	100 ml	1/10	4103810105975

Smar (biaty)

Grease (white) / Schmierfett (weiß) / Смазна (белая) / Маснина (біла) / Kenőzsír (fehér) / Unsoare (albă) / Mazivo (bílá) / Mazivo (biele) / Mazivo (bela) / Tepalas (baltais) / Smēre (balta) / Määrdeaine (valge) / Грес (біла) / Mast (bijela) / Mazivo (bela) / Λευκό γράσο / Lubrificante (blanco) / Lubrificante (bianco) / Lubrificante (branco) / Graisse (blanche) / Vet (wit)



Ref.	info	📦	EAN
09 116	400 ml	1/12	4103810091162

Oczyszczacz hamulców

Brake cleaner / Bremsenreiniger / Очиститель тормозов / Очистник гальм / Fékisztító / Agent de curățare frână / Čistič brzd / Čistič brzd / Sredstvo za čišćenje zavor / Stabdžij valiklis / Bremzu tīrītājs / Piduripuhasti / Почистачко устројство за спирачки / Sredstvo za čišćenje kočnica / Čistač kočnica / Καθαριστικό φρένων / Limpador de frenos / Pulitore di freni / Limpador de travões / Nettoyant pour freins / Remmenreiniger



Ref.	info	📦	EAN
09 126	500 ml	1/12	4103810091261

Ordzewiacz

Rust remover / Rostlöser / Средство для удаления ржавчины / Засіб для видалення іржі / Rozsádláč / Agent de îndepărtare a ruginei / Odstraňovač rzi / Pripravok na odstraňovanie hrdz / Sredstvo za odstranjevanje rje / Rūdžiju šalinimo priemonė / Rūsas noņemšanas līdzeklis / Rooste-estmalaja / Препарат за отстраняване на ръжда / Sredstvo za uklanjanje hrđe / Sredstvo za uklanjanje rđe / Απαρετκό αοιδιάς / Desoxidante / Eliminatore di ruggine / Removedor de ferrugem / Antrivouille / Roestverwijderaar



Ref.	info	📦	EAN
09 102	400 ml	1/12	4103810091025

Spray-silikon

Silicon-Spray / Silikon-Spray / Силиконовый спрей / Силиконовий спрей / Szilikon spray / Spray-silicon / Sprej-silikon / Sprej - silikón / Silikonski sprej / Purškiamas silikonas / Aerosols-silikons / Silikonpihuus / Спрей-силикон / Sprej-silikon / Sprej-silikon / Σπρέι σιλκόνης / Silicona en spray / Silicone spray / Silicone em spray / Silicone en spray / Spray-siliconen



Ref.	info	📦	EAN
09 124	400 ml	1/12	4103810091247

Smар uniwersalny

Universal grease / Universalfett / Смазна универсальная / Маснина универсальне / Univerzální kenőzsír / Lubrifiant universal / Viscócelové mazivo / Univerzálné mazivo / Univerzalno mazivo / Univeršalus tepalas / Univeršāla smēre / Univeršaalne määrdeaine / Univeršalno gres / Višenamjenska mast / Mazivo univerzalno / Γράσο γενικής χρήσης / Lubrificante universal / Lubrificante universale / Lubrificante universal / Graisse universelle / Universeeel vet



Ref.	info	📦	EAN
10 564	80 g	1/10	4103810105647

Lejek

Funnel / Trichter / Воронка / Воронка / Tölcsér / Pálnie / Návleka / Lievik / Ljajak / Piltuvélis / Piltuve / Lehter / Фунія / Lijevak / Levak / Χωβί / Embudo / Imbuto / Funil / Entonnoir / Trechter



Ref.	info	📦	EAN
02 366	ø210 x 24.5 mm	1/6	4103810023668
02 372	ø160 x 21.5 mm	1/6	4103810023729
02 562	ø160 x 20.0 mm	1/6	4103810025624

Kanister na benzynę

Can for petrol / Benzinbehälter / Канистра для бензина / Kanistra для бензину / Benzinkanpa / Bidon de benzina / Kanistr na benzin / Kanistra na benzin / Kanister za vodu / Bakas benziniui / Udens kanna / Benzina kanna / Bensiinkanister / Бидон за бензин / Kanister za benzin / Kanta za benzin / Κάνιστρο βενζίνης / Bidón para gasolina / Tanica per la benzina / Tanque para gasolina / Jerrycan à essence / Jerrycan voor benzien



21 127

21 127-950

Ref.	info	📦	EAN
21 127	20 l	1/0	4103810211270
21 127-950	20 l	1/0	4103810424571

Olejarka z końcówką sztywną

Oiler with rigid spout / Öler mit steifer Endung / Масленка с трубкой / Оливница зі штивним наконечником / Olajoz mérő csőrel / Ungator cu piesa de imbinare rigidă / Maznička s pevnou koncevkou / Olejnička s pevným nástavkom / Kanta za ulje s togim nastavkom / Terpaline su kietu antgaliu / Eļļotājs ar cieto uzgali / Jaiga otsakuga šlikam / Масльонка с твёрд наконечник / Kanticca za ulje s krutom crijevom / kanticca za ulje sa krutom kurot / Λιπαντήρας με στόμιο / Aceiteira con punta rígida / Oliatore con tubo rigido / Azeiteira para lubrificação com ponta rígida / Huiluse de avec embout rigide



Ref.	info	📦	EAN
05 114	350 ml	1/6	4103810051142
05 115	500 ml	1/6	4103810051159

Naczynie pomiarowe z pokrywką

Measurement vessel with cover / Messbecher mit Deckel / Мерный сосуд с крышкой / Мярна посудина з кришкою / Měřoděrný jedléňel / Vas de măsurare cu sarac / Měřici nádoba s víktem / Odmerná nádoba s vekom / Merilna posoda s pokrovom / Matavimo indas su dangteliu / Měřisanas trauks ar vaku / Kaenega tōdētēnūd / Измервателен съд с капак / Mjerna posuda s poklopcem / Merna posoda sa poklopcem / Δοσομετρικής με καπάκι / Recipiente de medición con tapa / Misurino con copercchio / Recipiente de medida con tampa / Récipient de mesure avec couvercle / Maatbeker met deksel



Ref.	info	📦	EAN
07 621	1 l	1/6	4103810076213
07 622	2 l	1/6	4103810076220
07 623	3 l	1/6	4103810076237

Smarownicza

Grease nipple / Öler / Масленка / Оливница / Zsírószeg / Cană de ungere / Maznička / Maznička / Mazalica / Terpaló - dozatorius / Ελκω κάπνισα / Vajke määderimp / Ръчна масленка / Dozer za mazivo / Mala mazalica / Ελασθεζομενής / Engrasadora / Puncto di ingrassaggio / Lubrificador / Raccord de graissage / Smeernippel



Ref.	info	📦	EAN
15 007	H1, M6 x 1	1/100	5902062011756
15 009	H1, M8 x 1	1/100	5902062011749
15 013	H1, M10 x 1	1/100	4103810440144
15 113-140	H2, M10 x 1	1/100	5902062153975

Kanister na wodę

Can for water / Wasserbehälter / Канистра для воды / Kanistra для воуи / Vizeskanpa / Bidon de apă / Kanistr na vodu / Kanistra na vodu / Kanister za vodu / Bakas vandeniui / Udens kanna / Veekanister / Бидон за вода / Kanister za vodu / Kanta za vodu / Κάνιστρο νερού / Bidón para agua / Tanica per l'acqua / Tanque para água / Jerrycane à eau / Jerrycan voor water



Ref.	info	📦	EAN
21 163	10 l	1/0	4103810211638
21 165	15 l	1/0	4103810211652
21 167	20 l	1/0	4103810211676
21 169	35 l	1/0	4103810211690

Dozownik do oleju

Liquid measure / Öldosierseineheit / Стакан измерительный / Дозатор оливиный / Olajadagoló / Dozator de ulei / Dávkovác na olej / Dávkováč oleja / Dozinkic za olje / Terpaló dozatorius / Eļļas dozētājs / Öldosator / Маслен дозатор / Dozer za ulje / Dozer za ulje / Μεζούρα λαδιού / Dosificador para aceite / Dosatore per olio / Dispensador de óleo / Doseur d'huile / Doseermat voor olie



Ref.	info	📦	EAN
07 605	5 l	1/6	4103810076053

Końcówka smarownicza

Grease coupler / Schmiernippel / Насадка / Наконечник эмазювальний / Zsírözéf / Piesa de ungere / Mazaci koncevka / Mazaci nástavec / Mazalni nastavek / Antgaliu / Cetržokļu ieeļošana / Määrimisotsak / Четурчелюстен / Glava mazalice / Podmazna kupa / Тоок γρασδαόρου / Punta de engrase / Testina ingrassatore / Ponta de lubrificação / Embout de graissage



Ref.	info	📦	EAN
12 643	M10x1	1/0	4103810126437
12 631	M10x1	1/0	4103810126314

Weżyk giętki

Hose / Schlauch / Шланг для смазочных шприцев / Шланг / Fleibilis tömlö / Furtun / Pružná hadice / Ohybná hadička / Gibka cev / Lanksti žarnele / Šlütene / Paindun voolik / Шланг за смазочни шприцовки / Fleksibilno crijevo / Savitljivo crevo / Εύκαμπτος σωλήνας για γρασδαόρου / Tubo fleible / Tubo flessibile / Mangueira fleivel / Fleible de Emmer



Ref.	info	📦	EAN
12 655-810	11 x 300 mm + 12 631	1/0	4103810420290
12 665-810	11 x 500 mm + 12 631	1/0	5902062000333
12 656-810	8 x 300 mm + 12 631	1/0	4103810426506
12 666-810	8 x 500 mm + 12 631	1/0	5902062153371

Smarownica dźwigniowa

Lever-operated grease gun / Schmierspritze mit Hebel / Шприц рычажно-плунжерный / Шприц важільно-плунжерный / Karos zsírzó / Gresor cu parghie / Páková maznice / Páková mazica / Ročna mazalka / Rankinis tepalo presas / Ieļļotājs ar sviru / Kangiga määrimisese / Ръчна маслянка / Mazalica ručna / Mazalica na pumpu / Γρασαδόρος με χελά / Engasadora de palanca / Ingrassatore a leva / Pistola de lubrificação / Graisseur à levier



Ref.	info		EAN
12 632	500 cm ³ + 12 635 +12 631	1/0	4103810126321



Ref.	info		EAN
12 636-101	500 cm ³ + 12 655 +12 631	1/0	4103810129810



Ref.	info		EAN
12 679	500 cm ³ + 12 655 +12 643	1/0	4103810126796



Ref.	info		EAN
12 630	500 cm ³ + 12 656 +12 631	1/0	4103810126307

Smarownica na pojemniku

Grease pump with container / Schmiergerät mit Behälter / Маслораздаточная установка / Дозатор оливи на емності / Tartályos zsírzó / Gresorul cu rezervor / Maznice na zásobniku / Maznica na zásobniku / Mazalnik z rezervoarjem / Tepalnice su talpykła / Eļļas sadales iekārta / Ölörüstöl koos õlitahtuga / Маслянка с резервоар / Mazalica na spremniku / Mazalica na kontejneru / Δοσομετρική αντλία παροχής λιπαντικού / Engasadora con depósito / Pompa manuale per grasso / Lubrificador no recipiente / Graisseur sur récipient / Smeerapparaat op bak



Ref.	info		EAN
17 786	8 kg	1/0	4103810177866

Smarownica nożna

Foot grease pump / Fuß-Schmiergerät / Маслораздаточная установка / Оливорозливочна ніжний / Lábpedálos zsírzó / Gresor actionat cu piciorul / Nožní maznice / Maznica poźná / Nožní mazalník / Mobilis tepalo talpykła / Eļļas sadales iekārta / Jalg-õlörüstöl / Ръчна маслянка / Nožna mazalica / Nožna mazalica / Δοσομετρική αντλία παροχής λιπαντικού / Engasadora de pie / Pompa a pedale per grasso / Lubrificador de comando de pernas / Graisseur à pied / Voetsmeerapparaat



Ref.	info		EAN
17 793	15 kg	1/0	4103810177934

Smarownica pneumatyczna

Pneumatic grease gun / Pneumatisches Schmiergerät / Соплодонагнетатель пневматический / Дозатор оливи пневматичний / Pneumatikus zsírzó / Gresor pneumatic / Pneumatická maznice / Maznica pneumatická / Pnevmatisks mazinālis / Tepalīne pneumatīne / Pneimatiska solidola spiede / Pneumaattiline öljupistool / Маслянка пневматична / Pnevmatiskska mazalica / Pnevmatiskska mazalica / Γρασαδόρος αέρος / Engrasadora neumática / Ingrassatore pneumatico / Lubrificador neumático / Graisseur pneumatique / Pnevmatisks smeerapparaat



Ref.	info	☐	EAN
18 071	500 cm ³ + 12 635 +12 631	1/0	4103810180712

Odciągarka do oleju

Oil suction gun / Ölabzieher / Отсосное устройство для масла / Оливодсмоктувач / Olajleszívó / Trägator de ulei / Odsávacia oleje (ruční) / Odsávacia na olej / Alyvos siurblys / Eļļas atvilcējs / Ölisistal / Зосмувача масляна помпа / Sisäljika za ulje / Pumpa za ispušpanjeje ulja / Ανορθωτήρας λαδιού / Dispositivo de extracción de aceite / Aspiratore olio / Máquina de remover óleo / Vidangeur d'huile / Olieafzuiger



Ref.	info	☐	EAN
12 902	500 ml	1/0	4103810129025
12 908	1 000 ml	1/0	4103810129087

Wanna do oleju

Oil drain bucket / Ölwanne / Ванночка для масла / Ванна оливна / Olajkád / Baie de ulei / Vana na olej / Vaia na olej / Posoda za olje / Vonele teraluu / Vanniņa eļļai / Öliwann / Vana za masno / Posuda za ulje / Καδα za ulje / Λεκανή αποστράγγισης λαδιού / Bandeja para aceite / Vaschetta per olio / Bandeja para troca de óleo / Bac à huile



Ref.	info	☐	EAN
24 110	6 l	1/5	4103810241109

Zestw pneumatyczny do smaru

Air operated grease kit / Ölset pneumatisch / Пневматический набор для смазывающего вещества / Комплект пневматичний до мастила / Pneumatikus felszerelés kenőzsírokhoz / Set pneumatic pentru unsoare consistentă / Pneumatická sada pro mazivo / Pneumatická súprava na mazanie / Pnevmatiski komplet za mazivo / Pnevmatisks komplekts, tepalui / Smērvielas pnevmatisks komplekts / Pneumaattiline määrdekomplekt / Пневматичен смазочен комплект / Pnevmatisks set za mazivo / Pnevmatiski pribor za mazivo / Пневматикi set για λιπαντικά / Juego de herramientas neumáticas para engrase / Completo pneumatico per il grasso / Kit neumático p. lubrificação / Jeu d'accessoires pneumatiques à graisse / Laspparaat



18 417 051

18 766 950

Ref.	info	☐	EAN
18 417 051	50:1, 20 kg	1/0	5902062154026
18 766 950	50:1, 50 kg	1/0	5902062154040

Pompa ręczna do oleju

Hand pump for oil / Handölpumpe / Ручной насос для масла / Pompa ручна do oliwui / Kézi olajpumpa / Pompa manuală, pentru ulei / Ruční pumpra na olej / Ručné čerpadlo na olej / Ročna črpalka za olje / Rankinė alyvos pompa / Manuālais eļļas sūkņis / Kási-ölpumpra / Ръчна масляна помпа / Ručna pumpra za ulje / Ručna pumpra za ulje / Χειροκίνητη αντλία λαδιού / Vomba manual para aceite / Pompa dell'olio manuale / Bomba de óleo manual / Pompe à main à huile / Handpomp voor olie



13 012

13 055

13 020

Ref.	info	☐	EAN
13 012	18 l / min.	1/0	4103810130120
13 020	7 l / min.	1/0	4103810130205
13 055	15 l / min.	1/0	4103810130557

Zlewarka oleju

Oil drain tank / Ölabgießer / Сливная воронка для масла / Обладнання для зливання оливи / Olajleeresztó tartály / Cuvetă de scurgere uleiului / Slevačka oleje / Nádrž na zachytávanie oleja / Zbiralnik olja / Tepalo išleidiklis / Eļļas piltuve / Öllehtrite komplekt / Машина за изливане на масло / Aparat za skupljanje ulja / Odlivak za ulje / Dispositivo de drenaje de aceite / Recuperatore olio / Máquina de remoção de óleo / Cuve à récupérer l'huile / Verbindungsstück



Ref.	info		EAN
27 030	70 l	1/0	5902062153326
27 070	70 l	1/0	5902062153333

Odsysarka oleju

Oil suction machine / Ölabsauger / Отсосное устройство для масла / Оливодсмоктувач / Olajleszívó / Aspirator de ulei / Odsávačka oleje / Odsávačka oleja / Aspirator za olje / Alyvos siurbtukas / Eļļas atsūcējs / Öliimur / Вакуумна пома за масло / Skupljač ulja / Usisivač za ulje / Αναρροφητήρας λαδιού / Dispositivo de extracción de aceite / Aspiratore olio / Máquina de remover óleo / Vidangeur d'huile / Oliefazzuiger



Ref.	info		EAN
27 622	70 l	1/0	5902062153340
27 632	70 l	1/0	5902062153357

Zestaw pneumatyczny do smaru

Air operated grease kit / Schmierstoffset pneumatisch / Пневматический набор для смазывающих веществ / Комплект пневматичної до мастила / Pneumatikus felszerelés kenőzsírokhoz / Set pneumatic pentru unsoare consistentă / Pneumatická sada pro mazivo / Pneumatický komplet na mazanie / Pnevmatiski komplet za mazivo / Pneumatinis komplekts, tepalui / Smērvielu pneimatiskais komplekts / Pneumatiline mārdekomplekt / Пневматичен смазочен комплект / Pneumatski set za mazivo / Pnevmatiski komplet maziva / Πνευματικό σετ για λιπαντικά / Juego de herramientas neumáticas para engrase / Kit ingrassaggio pneumatico / Kit pneumático p. lubrificante / Jeu d'accessoires pneumatiques à graisse / Set van knippers en doorslagen



Ref.	info		EAN
27 846	50:1, 50/60 kg	1/0	5902062154026
27 846-950	50:1, 20 kg	1/0	5902062154040

ZORAN KASTRATOVIĆ

...I use NEO tools to service my cars before and after races. They never let me down...

Kastratović Zoran

Kierowca wyścigowy z Serbii. Od ponad ćwierć wieku na torze. Nawet po tak długim okresie aktywności mówi, że jego miłość do wyścigów, nie zmniejszyła się. Podczas kariery zdobył 6 tytułów narodowych i nagrodę Złotego Kasku dla najlepszego sportowca, ale jego największym skarbem są jego dwie córki.

Zoran rozpoczął swoją karierę jako debiutant w najniższej klasie rankingowej, ale szybko dotarł do klasy Super Touring. Był jednym z pierwszych kierowców wyścigowych z Serbii, który zaczął startować w Europie i mistrzostwach CEZ. Swoje pierwsze trofeum FIA osiągnął jako numer jeden w klasie D4-2000 dla strefy Europy Środkowej w 2017 roku.

Racing driver from Serbia, with a career that spans more than quarter of a century. Even after being active for such a long time, he says that his love for motorsport hasn't diminished at all. On his shelves you'll find 6 national titles and a Golden helmet award for best sportsman, among dozens of other trophies that he has won in circuit and hill climb races, but his greatest treasures are his two daughters.

Zoran started his career as a rookie in the lowest ranking class, but quickly drove all the way up to the Super Touring Class. When that wasn't enough, he was among the first racing drivers from Serbia that started competing in Europe and in the CEZ Championship as a privateer. He achieved his first FIA trophy ranking as number one in Central European Zone D4-2000 class in 2017. Jean Todt, president of FIA, presented the trophy to him.

Автогонщик из Сербии. В спорте уже более четверти века. Но, по его словам, даже после столь долгой активной деятельности его любовь к гонкам не уменьшилась. За свою карьеру он выиграл 6 национальных титулов и приз «Золотой шлем» для лучшего спортсмена, но его самым большим сокровищем являются две его дочери.

Zoran начал свою карьеру новичком в классе с самым низким рейтингом, но быстро пробился в класс Super Touring. Он был одним из первых автогонщиков из Сербии, который начал выступать на первенствах Европы и чешских чемпионатах CEZ. Свой первый кубок FIA он завоевал как номер один в классе D4-2000 для Центральной Европы в 2017 году.





NEO
TOOLS
GRAPHITE